

HP 87510A
Gain-Phase Analyzer
Operation Manual

THE UNIVERSITY OF CHICAGO
 LIBRARY
 540 EAST 57TH STREET
 CHICAGO, ILL. 60637

1980

THE UNIVERSITY OF CHICAGO
 LIBRARY
 540 EAST 57TH STREET
 CHICAGO, ILL. 60637

THE UNIVERSITY OF CHICAGO
 LIBRARY
 540 EAST 57TH STREET
 CHICAGO, ILL. 60637

HP 87510A Gain Phase Analyzer

Operation Manual

MANUAL IDENTIFICATION

Model Number: HP 87510A
Date Printed: Dec 1991
Part Number: 87510-90000

This supplement contains information for correcting manual errors and for adapting the manual to newer instruments that contains improvements or modifications not documented in the existing manual.

To use this supplement

1. Make all ERRATA corrections
2. Make all appropriate serial-number-related changes listed below

SERIAL PREFIX OR NUMBER	MAKE MANUAL CHANGES
3240J00290 or later	Change 1
3427J	Change 1 and 2

◆ New Item

FIRMWARE VESION	MAKE MANUAL CHANGES
Rev 2.02 or Later	CHANGE 1
Rev 2.10 or Later	CHANGE 1 and 2

NOTE

Manual change supplement are revised as often as necessary to keep manuals as current and accurate as possible. Hewlett-Packard recommends that you periodically request the latest edition of this supplement. Free copies are available from all HP offices. When requesting copies, quote the manual identification information from your supplement, or the model number and print date from the title page of the manual.



Change 1

HP-IB Programming Manual Part

Chapter 3 HP-IB Programming Reference

The following HP-IB commands have been added to the HP 87510A with firmware revision 2.02.

LMAXS?
LMINS?
MAXD?
OUTPPEAK?
RPLPPS?
SEET
SINDTMEM
SINSPEAK
TARLRP?

SINDTMEM {ON|OFF}

SINDTMEM ON makes the analyzer store data trace to the sub-trace with each sweep. (Query)

SINSPEAK □ {ON|OFF}

SINSPEAK ON makes the analyzer search the maximum or minimum point with each sweep.

OUTPPEAK?

Outputs the maximum and minimum values when SINSPEAK is set to ON. (Query)

Query response. {*minimum value*}{*stimulus value at the minimum point*}{*maximum value*}{*stimulus value at the maximum point*}{*maximum value – minimum value*}{*number of points at minimum point*}{*number of points at the maximum point*}<new line><END>

TARLRP? *value1 value2*

Searches the point at a specified target point from a point at a specified stimulus value. (Query)

value1 target value
value2 start point to search

Query response. {*stimulus value of left target point*},{*stimulus value of right target point*}<new line><END>

MAXD?

Outputs the maximum and minimum of difference between Data Trace and Sub-trace (Data Trace – Sub Trace). (Query only)

Query Response. {*Minimum value*},{*stimulus value at minimum point*},{*maximum value*},{*stimulus value at the maximum point*}<new line><END>

RPLPPS?

Searches for the maximum ripple peak to peak value and outputs the resultant data and stimulus values at these points. (Query only)

Query Response. {*maximum ripple peak*},{*stimulus value at local maximum point*},{*stimulus value at local minimum point*} <new line><END>

LMAXS? \lfloor value

Outputs the *n*th local maximum value and stimulus value from the left of range which is set by the ANARANG command. (Query only)

value 1 ~

Query response. {*n th local maximum value*},{*stimulus value at the local maximum point*} <new line><END>

3.40282347E+38 will be output when no appropriate points are found.

LMINS? \lfloor value

Outputs the *n*th local minimum value and stimulus value from the left of range which is set by the ANARANG command. (Query only)

value 1 ~

Query Response. {*n th local maximum value*},{*stimulus value at the local minimum point*} <new line><END>

3.40282347E+38 will be output when no appropriate points are found.

SEET {ON|OFF}

SEET ON makes the analyzer display both of text displayed using PRINT statement of HP Instrument BASIC and measurement traces.

Using HP Instrument BASIC with the HP 87510A Part

Page A-3, Table A-1. HP-IB Commands for EXECUTE

Add the following commands to the table A-3:

LMAXS?
LMINS?
MAXD?
OUTPPEAK?
RPLPPS?
SEET
SINDTMEM
SINSPEAK
TARLRP?



Change 2

HP-IB Programming Manual Part

Chapter 3 HP-IB Programming Reference

The following HP-IB commands have been added to the HP 87510A with firmware revision 2.10.

ATTW
UPDD

ATTW value

Sets the waiting time when the attenuator switch is changed at the power sweep mode. The waiting time is defined by *value* multiplied by 250 μ sec. (Option 010 only, No warning will be shown even if this command is executed with the HP 87510A with no option 010.) The power-on default setting is 1 ms. The preset does not have effect on this setting.

value 1 ~ 255

UPDD{ON|OFF}

Sets the refresh of the display on or off. When UPDD is turned ON, the operating speed to measure or setup will be faster. It is recommended to use this command with ALL BASIC to avoid to make a misreading because the status display on the CRT may not coincide with a current status when UPDD is turned OFF. This command is also effect to the list table. When UPDD is turned OFF, the list table does not display during editing the table. This command is not effect to the limit table.



**HP 87510A
Gain Phase Analyzer
Operation Manual**

MANUAL IDENTIFICATION

Model Number: HP 87510A
Date Printed: Dec. 1991
Part Number: 87510-90000

This supplement contains information for correcting manual errors and for adapting the manual to newer instruments that contains improvements or modifications not documented in the existing manual.

To use this supplement

1. Make all ERRATA corrections
2. Make all appropriate serial-number-related changes listed below.

SERIAL PREFIX OR NUMBER MAKE MANUAL CHANGES

SERIAL PREFIX OR NUMBER	MAKE MANUAL CHANGES

SERIAL PREFIX OR NUMBER MAKE MANUAL CHANGES

SERIAL PREFIX OR NUMBER	MAKE MANUAL CHANGES

► New Item

ERRATA

Replace the following pages with the attached replacement pages of this supplement.

Reference Manual part

- Page C-3, 4: Original to Rev:2/92
- Page C-5, 6: Original to Rev:2/92
- Page C-7, 8: Original to Rev:2/92
- Page D-1, 2: Original to Rev:2/92

HP-IB Programming Manual part

- Page 2-13, 14: Original to Rev:2/92
- Page 2-27, 28: Original to Rev:2/92
- Page 2-39, 40: Original to Rev:2/92
- Page 3-43, 44: Original to Rev:10/92
- Page 3-63, 64: Original to Rev:10/92
- Page E-17, 18: Original to Rev:2/92
- Page E-19: Original to Rev:2/92

NOTE

Manual change supplement are revised as often as necessary to keep manuals as current and accurate as possible. Hewlett-Packard recommends that you periodically request the latest edition of this supplement. Free copies are available from all HP offices. When requesting copies, quote the manual identification information from your supplement, or the model number and print date from the title page of the manual.



OUTPUT1 Output Signal or OUTPUT2 Output Signal

This signal (latch output signal) can be set at the low or high level by inputting a negative pulse to INPUT1 or using an HP-IB command. (Related HP-IB commands: OUT1H, OUT1L, OUT2H and OUT2L)

PASS/FAIL Output Signal

This signal is set to a high level (positive logic) or to a low level (negative logic) when the limit testing result is OK (PASS). It is set to a low level (positive logic) or to a high level (negative logic) when the test result is NG (FAIL). This signal is effective only when the limit test function is ON.

WRITE STROBE Output Signal for PASS/FAIL Output

When the limit testing result is output to the PASS/FAIL output line, a negative pulse is output to WRITE STROBE OUTPUT. This output signal notifies external devices of the limit testing result output to the PASS/FAIL OUTPUT.

SWEEP END Output Signal

When the HP 87510A completes a sweep, a negative pulse is output. The pulse width is 10 μ s.

A +5 V output pin is provided for an external device. A maximum of 100 mA current may be supplied. This line has no phase. However, if an excess current flows, a protective circuit functions to cut off the main power of the HP 87510A. When the overcurrent subsides, the main power is turned ON again. In this case, all device settings are initialized.

Figure C-2 shows the schematic drawing of input/output ports and control signal lines.

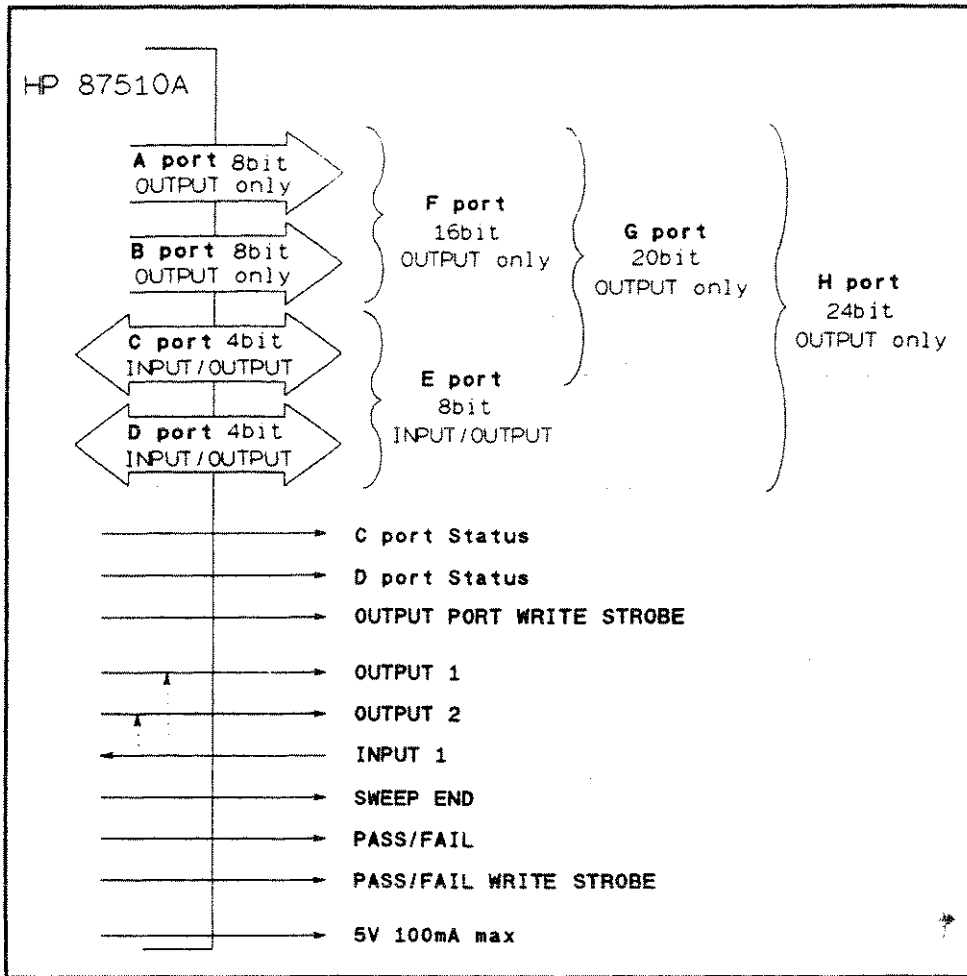

Figure C-2. Schematic Drawing of Parallel I/O Ports

Pin Assignment

Figure C-2 shows pin numbers. Table C-1 shows assignment of signals to pins.

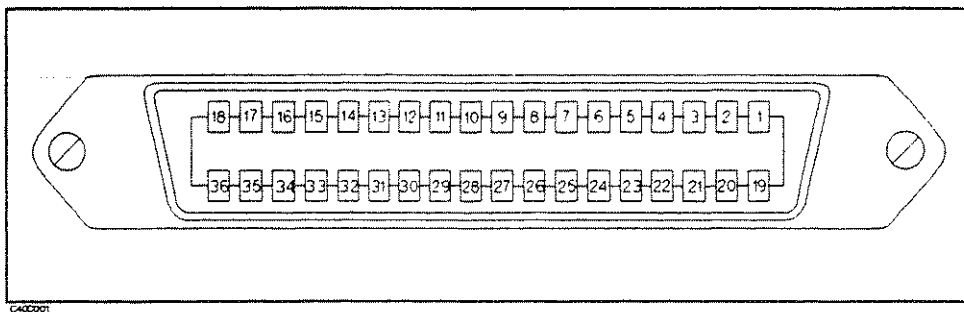

Figure C-3. Parallel I/O Port Connector Pin Numbers

Table C-1. Assignment of Signals to Pins (Standard)

Pin No.	Signal Name	Signal Standard
1	GND	0 V
2	INPUT1	TTL level, Pulse input, Pulse width of 1 μ s or more
3	OUTPUT1	TTL level, Latch output
4	OUTPUT2	TTL level, Latch output
5	Output port A0	TTL level, Latch output
6	Output port A1	TTL level, Latch output
7	Output port A2	TTL level, Latch output
8	Output port A3	TTL level, Latch output
9	Output port A4	TTL level, Latch output
10	Output port A5	TTL level, Latch output
11	Output port A6	TTL level, Latch output
12	Output port A7	TTL level, Latch output
13	Output port B0	TTL level, Latch output
14	Output port B1	TTL level, Latch output
15	Output port B2	TTL level, Latch output
16	Output port B3	TTL level, Latch output
17	Output port B4	TTL level, Latch output
18	Output port B5	TTL level, Latch output
19	Output port B6	TTL level, Latch output
20	Output port B7	TTL level, Latch output
21	Input/output port C0	TTL level, Latch output
22	Input/output port C1	TTL level, Latch output
23	Input/output port C2	TTL level, Latch output
24	Input/output port C3	TTL level, Latch output
25	Input/output port D0	TTL level, Latch output
26	Input/output port D1	TTL level, Latch output
27	Input/output port D2	TTL level, Latch output
28	Input/output port D3	TTL level, Latch output
29	Port C status	TTL level, Input mode: Low, Output mode: High
30	Port D status	TTL level, Input mode: Low, Output mode: High
31	Write strobe signal	TTL level, Negative logic, Pulse output
32	+5 V pull-up	
33	SWEEP END signal	TTL level, Negative logic, Pulse output (Width: 10 μ s or more)
34	+5 V	+5 V, 100 mA max.
35	PASS/FAIL signal	TTL level, PASS: High, FAIL: Low, Latch output
36	Write strobe signal	TTL level, Negative logic, Pulse (for PASS/FAIL) output

Table C-2. Assignment of Signals to Pins (Option 006)

Pin No.	Signal Name	Signal Standard
1	GND	0 V
2	INPUT1	TTL level, Pulse input, Pulse width of 1 μ s or more
3	OUTPUT1	TTL level, Latch output
4	OUTPUT2	TTL level, Latch output
5	Output port A0	TTL level, Latch output
6	Output port A1	TTL level, Latch output
7	Output port A2	TTL level, Latch output
8	Output port A3	TTL level, Latch output
9	Output port A4	TTL level, Latch output
10	Output port A5	TTL level, Latch output
11	Output port A6	TTL level, Latch output
12	Output port A7	TTL level, Latch output
13	Output port B0	TTL level, Latch output
14	Output port B1	TTL level, Latch output
15	Output port B2	TTL level, Latch output
16	Output port B3	TTL level, Latch output
17	Output port B4	TTL level, Latch output
18	Not used	
19	Output port B5	TTL level, Latch output
20	Output port B6	TTL level, Latch output
21	Output port B7	TTL level, Latch output
22	Input/output port C0	TTL level, Latch output
23	Input/output port C1	TTL level, Latch output
24	Input/output port C2	TTL level, Latch output
25	Input/output port C3	TTL level, Latch output
26	Input/output port D0	TTL level, Latch output
27	Input/output port D1	TTL level, Latch output
28	Input/output port D2	TTL level, Latch output
29	Input/output port D3	TTL level, Latch output
30	Port C status	TTL level, Input mode:Low, Output mode:High
31	Port D status	TTL level, Input mode:Low, Output mode:High
32	Write strobe signal	TTL level, Negative logic, Pulse output
33	SWEEP END signal	TTL level, Negative logic, Pulse output (Width: 10 μ s or more)
34	PASS/FAIL signal	TTL level, PASS:High, FAIL: Low, Latch output
35	+5 V	+5 V, 100 mA max.
36	Write strobe signal	TTL level, Negative logic, Pulse output

HP-IB Commands for Parallel I/O Port Control

The HP-IB commands related to parallel I/O ports are summarized below. For more information on HP-IB commands, *see the HP-IB Programming Manual.*

Note



The HP-IB commands summarized below are used to control the standard Parallel I/O and Option 006. For the HP-IB commands related to Option 005 (8-bit I/O), *see Appendix D.*

Data Output Commands

The following commands output data to the corresponding ports (A to H). When ports C, D, E, F, G, and H are used as output ports, ports C and D must be defined as output ports using HP-IB commands (COUT and DOUT).

- OUTAIO outputs 8-bit data to port A.
- OUTBIO outputs 8-bit data to port B.
- OUTCIO outputs 4-bit data to port C.
- OUTDIO outputs 4-bit data to port D.
- OUTEIO outputs 8-bit data to port E.
- OUTFIO outputs 16-bit data to port F.
- OUTGIO outputs 20-bit data to port G.
- OUTHIO outputs 24-bit data to port H.

Data Input Commands

The following commands read data from the corresponding input ports (C to E) and returns the values to the HP-IB. Before receiving data, ports C and D must be defined as input ports using HP-IB commands (CIN and DIN).

- OUTPINPCIO? reads 4-bit data from port C and returns its value to the HP-IB.
- OUTPINPDIO? reads 4-bit data from port D and returns its value to the HP-IB.
- OUTPINPEIO? reads 8-bit data from port E and returns its value to the HP-IB.

Commands for Setting Input/Output Directions of Ports C and D

The following commands set the input/output directions of ports C and D. When the power is turned ON, ports C and D are defined as input ports. Pressing **PRESET** key do not affect this setting. This setting is saved to an instrument state file using the Save function.

- CIN defines port C as an input port.
- COUT defines port C as an output port.
- DIN defines port D as an input port.
- DOUT defines port D as an output port.

Positive and Negative Logic Setting Commands

The following commands set positive or negative logic for port input/output signals and PASS/FAIL output signal. When the power is turned ON, negative logic is set. Pressing **PRESET** key do not affect this setting. This setting is saved to an instrument state file using the Save function.

- NEGL sets negative logic.
- POSL sets positive logic.

OUTPUT1 and OUTPUT2 Level Setting Commands

The following commands set OUTPUT1 and OUTPUT2 levels:

- OUT1H sets OUTPUT1 at the high level.
- OUT1L sets OUTPUT1 at the low level.
- OUT2H sets OUTPUT2 at the high level.
- OUT2L sets OUTPUT2 at the low level.

Commands for Setting OUTPUT1 and OUTPUT2 at the High or Low Level upon input of a Pulse to INPUT1

The following commands set OUTPUT1 and OUTPUT2 at the high or low when a negative pulse is input to INPUT1. When the power is turned ON, both OUTPUT1 and OUTPUT2 are set at the high level. Pressing **(PRESET)** key do not affect this setting. This setting is saved to an instrument state file using the Save function.

- OUT1ENVH sets OUTPUT1 at the high level when a pulse is input to INPUT1.
- OUT1ENVL sets OUTPUT1 at the low level when a pulse is input to INPUT1.
- OUT2ENVH sets OUTPUT2 at the high level when a pulse is input to INPUT1.
- OUT2ENVL sets OUTPUT2 at the low level when a pulse is input to INPUT1.

Command for Checking Input to INPUT1

This command checks whether a pulse has been input to INPUT1. Sending this command after a pulse is input to INPUT1 will return a HIGH. If no pulse has been input to INPUT1, the return values will be LOW. After HIGH is received, succeeding values will be cleared. (set to LOW)

Option 005 Parallel I/O Mode A (8-bit)

This appendix provides information on the HP 87510A with Option 005 Parallel I/O Mode A (8-bit I/O port).

I/O Port

The I/O port on the analyzer rear panel communicates with the external devices such as a handler on a production line.

Pin Assignment

The 8-bit I/O port consists of 15 TTL compatible signals, which are 8-bit output, 4-bit input, sweep end, pass/fail, and ground. The pin assignments are shown in Figure D-1.

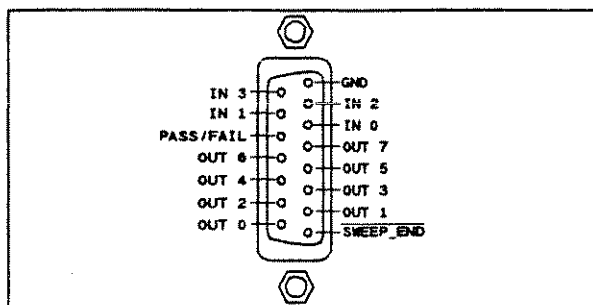

Figure D-1. 8-bit I/O Port Pin Assignments

The signals carried through each pin are described below.

<u>SWEEP_END</u>	outputs a negative pulse when the analyzer completes a sweep. The pulse width is $> 10 \mu\text{s}$.
OUT 0 thru 7	output signals to external devices and are controlled by two HP-IB commands, OUT8IO, as described below. Once OUT8IO is executed, the signal is latched until OUT8IO is executed again.
IN 0 thru 4	input signals from external devices and are read by the HP-IB command INP8IO, as described below.
PASS/FAIL	is affected only when the Limit Testing, described in "Limit Line and Limit Testing" in Chapter 12, is active. This signal is set HIGH and LOW if the test result is PASS and FAIL (positive logic), or FAIL and PASS (negative logic) respectively.

Related HP-IB Commands

There are six HP-IB commands which directly control an I/O port.

- OUT8IO** outputs 8-bit data to the OUT 0 thru 7 lines. The OUT 0 signal is the LSB (least significant bit), while the OUT 7 signal is the MSB (most significant bit).
- INP8IO** inputs 4-bit data from the IN 0 thru 3 signals to the analyzer's memory. The IN 0 signal is the LSB (least significant bit), while the IN 3 signal is the MSB (most significant bit).
- INP8IO?** inputs data from the 4-bit parallel input port to the HP 87510A, and outputs the data to the controller.
- NEGL** sets negative logic for the PASS/FAIL output signal. When the power is turned ON, negative logic is set. Pressing **PRESET** key do not affect this setting. This setting is saved to an instrument state file using the Save function.
- OUTPINP8IO?** is a query command which outputs 8-bit data to the controller. The data is obtained as 4-bit data by the INP8IO command and four upper significant bits (value = 0) are attached to extend the 4-bit data to 8-bit data.
- POSL** sets positive logic for the PASS/FAIL output signal. When the power is turned ON, negative logic is set. Pressing **PRESET** key do not affect this setting. This setting is saved to an instrument state file using the Save function.

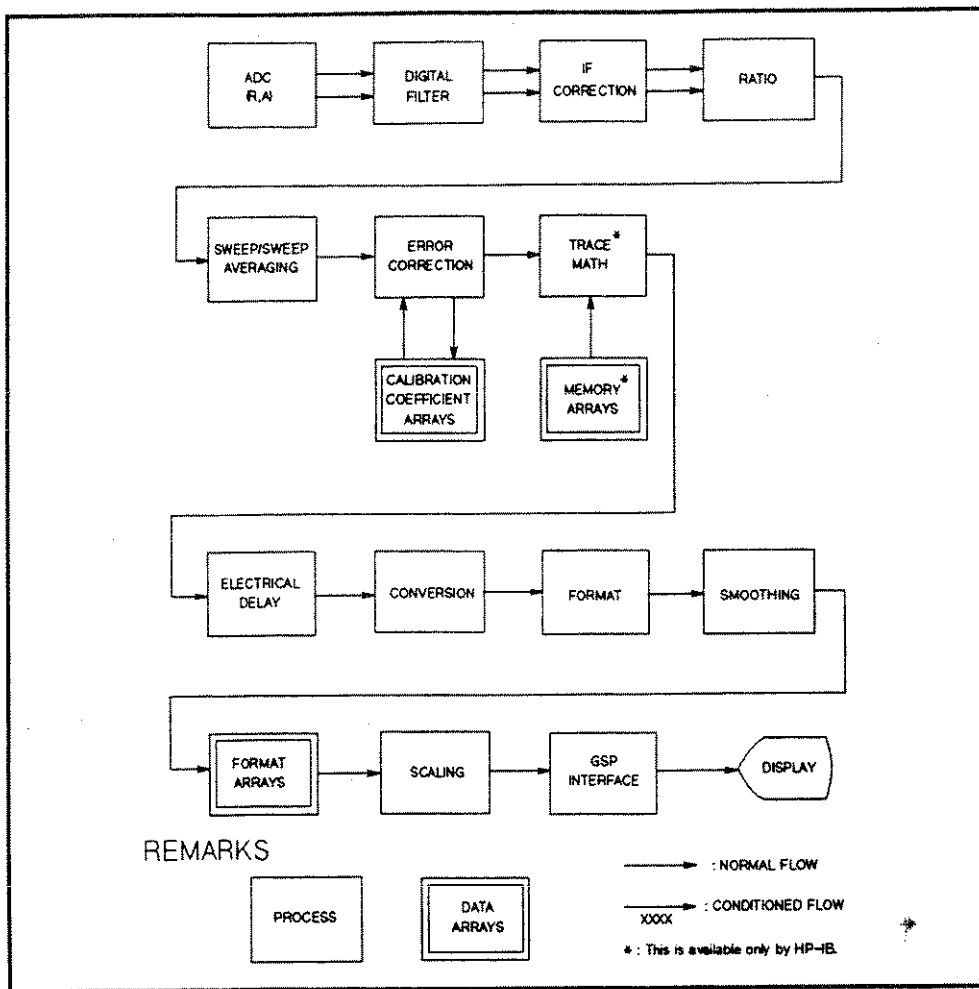

Figure 2-8. Data Processing Flow

Table 2-2. HP-IB Commands to Output Data Array

Data Output	Active Channel		Inactive Channel	
	Formatted Data		Formatted Data	
	Data Trace	Sub Trace	Data Trace	Sub Trace
Complex Data at All Points ¹	OUTPFORM?	OUTPTMEM?	OUTPPIFORM?	OUTPITMEM?
Complex Data at Specified Point ²	OUTPFORMP?	OUTPTMEMP?		
Real Data at All Point ³	OUTPRFORM?	OUTPRTMEM?	OUTPIRFORM?	OUTPIRTMEM?

1 Number of data output is two times of the Number Of Points (NOP).

2 Number of data output is two (a real part and an imaginary part).

3 Number of data output is equal to NOP.

Data Transfer Using ASCII Transfer Format (Form 4). When Form 4 is used, each number is sent as a 24 character string, each character being a digit, or decimal point.

```

10      !
20      ! Data Transfer Using ASCII Transfer Format
30      !
40      DIM Dat(1:201),Stim(1:201)
50      ASSIGN @Hp87510 TO 717 ! When iBASIC is used, change "717" to "800".
60      ABORT 7                ! When iBASIC is used, change "7" to "8".
70      CLEAR @Hp87510
80      !
90      OUTPUT @Hp87510;"PRES"           ! Preset HP 87510A
100     OUTPUT @Hp87510;"CHAN1; AR; LOGM"
110     INPUT "Enter center frequency (Hz).",F_cent
120     INPUT "Enter frequency span (Hz).",F_span
130     OUTPUT @Hp87510;"CENT ";F_cent
140     OUTPUT @Hp87510;"SPAN ";F_span
150     !
160     ON INTR 7 GOTO Sweep_end          ! Define branch when interrupt occurs
170     OUTPUT @Hp87510;"CLES"           ! Clear status registers
180     OUTPUT @Hp87510;"*SRE 4;ESNB 1" ! Set enable bits of STB and ESB
190     REPEAT                            ! Wait for registers are cleared
200     UNTIL SPOLL(@Hp87510)=0          ! Check STB
210     ENABLE INTR 7;2                  ! Set enable interrupt
220     OUTPUT @Hp87510;"SING"           ! Sweep mode is SINGLE
230     Loop_top:GOTO Loop_top           ! Wait until sweep end
240     Sweep_end:                        !
250     !
260     OUTPUT @Hp87510;"POIN?"          ! Query NOP
270     ENTER @Hp87510;Nop
280     OUTPUT @Hp87510;"FORM4"         ! Set ASCII Transfer Format
290     !
300     OUTPUT @Hp87510;"OUTPRFORM?"    ! Real part of the formatted trace data
310     ENTER @Hp87510;Dat(*)
320     !
330     OUTPUT @Hp87510;"OUTPSTIM?"     ! Stimulus data
340     ENTER @Hp87510;Stim(*)
350     !
360     FOR I=1 TO Nop
370         PRINT Stim(I);"Hz",Dat(I);"dB"
380     NEXT I
390     END

```

Figure 2-9. Sample Program: Data Transfer using ASCII Transfer Format (Form 4)

Lines 260 and 270	Find out how many points to expect.
Line 280	Tell the HP 87510A to use the ASCII transfer format.
Line 300	Request the real part of the formatted trace data.
Line 310	Transfer the data from the HP 87510A to the computer, and put it in the receiving array Dat(*).
Lines 330 and 340	Request and transfer the stimulus data.
Lines 340 through 380	Display data.

```

10      !
20      ! Reading Calibration Data
30      !
40      DIM Dat(1:201,1:2)
50      DIM Head$(6)
60      ASSIGN @Hp87510 TO 717 ! When iBASIC is used, replace "717" to "800".
70      ABORT 7 ! When iBASIC is used, replace "7" to "8".
80      CLEAR @Hp87510
90      !
100     INPUT "Connect THRU and press [Return] to do cal.",Dum$
110     GOSUB Setup
120     GOSUB Cal
130     OUTPUT @Hp87510;"SAVC" ! Re-draw trace
140     OUTPUT @Hp87510;"POIN?" ! Ask Number of points
150     ENTER @Hp87510;Nop ! Enter NOP
170     !
180     INPUT "Press [Return] to transmit cal data.",Dum$
190     ASSIGN @Dt TO 717;FORMAT OFF ! Set data I/O path
200     OUTPUT @Hp87510;"FORM3" ! IEEE 64-bit Floating Point Format
210     OUTPUT @Hp87510;"OUTPCALC01?" ! Query calibration array
220     ENTER @Dt USING "#,8A";A$ ! Enter header
230     ENTER @Dt;Dat(*) ! Enter data
240     ENTER @Dt USING "#,1A";B$ ! Enter terminator
250     INPUT "Transmit done. Disconnect THRU and press [Return].",Dum$
260     !
270     GOSUB Setup
280     GOSUB Cal
290     OUTPUT @Hp87510;"SAVC" ! Re-draw trace
300     !
310     INPUT "Press [Return] to retransmit cal data.",Dum$
320     V$=VAL$(Nop*2*8)
330     Numv=LEN(V$)
340     Head$="000000" ! Initialize header value
350     FOR I=1 TO Numv
360         Head$[7-I,7-I]=V$[Numv-I+1,Numv-I+1]
370     NEXT I
380     !
390     OUTPUT @Hp87510;"INPUCALC01 "; ! Store cal data by HP-IB
400     OUTPUT @Dt USING "#,8A";"#6"&Head$ ! Send header
410     OUTPUT @Dt;Dat(*),END ! Send data
420     OUTPUT @Hp87510;"SAVC" ! Re-draw trace
430     !
440     ASSIGN @Dt TO * ! Clear I/O path
460     DISP "Retransmit completed. Connect DUT."
470     OUTPUT @Hp87510;"CONT" ! Sweep mode is CONT
480     STOP
490     !

```

Figure 2-15. Reading Calibration Data (1/2)

```

500 Setup: !
510 F_cent=7.E+7
520 F_span=200000.
530 OUTPUT @Hp87510;"PRES;"
540 OUTPUT @Hp87510;"CHAN1; AR; LOGM"
550 OUTPUT @Hp87510;"CENT ";F_cent
560 OUTPUT @Hp87510;"SPAN ";F_span
570 OUTPUT @Hp87510;"SING"
580 RETURN
590 !
600 Cal: !
610 OUTPUT @Hp87510;"swet 4"
620 OUTPUT @Hp87510;"CALIRESP"
630 ON INTR 7 GOTO Sweep_end
640 OUTPUT @Hp87510;"CLES"
650 OUTPUT @Hp87510;"*SRE 4;ESNB 1"
660 REPEAT
670 UNTIL SPOLL(@Hp87510)=0
680 ENABLE INTR 7;2
690 OUTPUT @Hp87510;"STANC"
700 Loop_top:GOTO Loop_top
710 Sweep_end: !
720 !
730 OUTPUT @Hp87510;"*OPC?"
740 ENTER @Hp87510;Dum
750 OUTPUT @Hp87510;"RESPDONE"
760 RETURN
770 END

```

Figure 2-15. Reading Calibration Data (2/2)

Line 50	Declare the dimension part of the file header.
Line 110	Preset and set up the HP 87510A, and hold the trigger.
Line 120	Perform a response calibration.
Line 130	Re-draw the trace with the calibration data.
Line 210	Request outputting the calibration data.
Line 220	Enter the file header.
Line 230	Enter the calibration data.
Line 240	Enter the file terminator.
Line 280	Perform the calibration to set the correction ON.
Line 320	Calculate the number of bytes transferred, and represents it in the string format.
Line 330	Count the number of characters in the string which contains the number of bytes transferred.
Line 340	Enter 0 as the initial value in all header arrays.
Line 350 through 370	Place the number of bytes transferred to the header array digit by digit from the sixth array to the first array of the header.
Line 390 through 410	Send the file header and calibration data.

OFSD value [s]

Specifies the one-way electrical delay from the measurement (reference) plane to the standard.

(**OFFSET DELAY** under **CAL**)

value -10 to 10 (s)

OFSL value

Specifies energy loss, due to skin effect, along a one-way length of coaxial cable offset.

(**OFFSET LOSS** under **CAL**)

value 0 to 1.0×10^{19} (Ω/s)

OFSZ value [ohm]

Specifies the characteristic impedance of the coaxial cable offset.

(**OFFSET Z0** under **CAL**)

value 0.1 to 5.0×10^6 (Ω)

OPEP

Lists the key parameters for both channels 1 and 2 on the display.

(**OPERATING PARAMETERS** under **COPY**)

OPTI?

Returns installed option number of the front panel ports. If nothing is installed, OPTI? returns the string, "STD". If Option 004 (delete reference channel option) is installed, OPTI? returns "004". (query only)

OSE value

Enables the operational status register.

value 0 to 32,767

OSER?

Outputs the current value in the event register of an operational status register.

OSNT

Sets the negative transition filter of an operational status register. For details, refer to Appendix B. (Query)

OSPT

Sets the positive transition filter of an operational status register. For details, refer to Appendix B. (Query)

OSR?

Outputs the operational status register value.

OUT1ENVH

Sets OUTPUT1 set to HIGH when a pulse input has occurred at INPUT1.

OUT1ENVL

Sets OUTPUT1 set to LOW when a pulse input has occurred at INPUT1.

OUT1H

Sets OUTPUT1 to HIGH.

OUT1L

Sets OUTPUT1 to LOW.

OUT2ENVH

Sets OUTPUT2 set to HIGH when a pulse input has occurred at INPUT1.

OUT2ENVL

Sets OUTPUT2 set to LOW when a pulse input has occurred at INPUT1.

OUT2H

Sets OUTPUT2 to HIGH.

OUT2L

Sets OUTPUT2 to LOW.

OUT8IO *value*

Outputs the data to the 8-bit parallel output port. (Option 005 only)

value 0 to 255

OUTPFILT? *value*[*suffix*]

Outputs filter parameters within the range specified by the ANARANG command. Command parameter sets the offset of x dB to the maximum peak value to determine the cutoff points. For details, refer to Appendix E. (Data format: loss, bandwidth, center frequency, Q, $\Delta L.F$, $\Delta R.F$)

value Relative offset value from maximum
suffix refer to "Suffix"

OUTPFORM?

Outputs the formatted trace data (Data format: real, imaginary)

OUTPFORMP? *value*

Outputs the formatted trace data at the specified point (Data format: real, imaginary)

value 1 to "number of points"

OUTPIFORM?

Outputs the formatted data from the inactive channel (Data format: real, imaginary)

OUTPINP8IO?

Outputs the data entered from the 4-bit parallel input port. (option 005 only)

OUTPINPCIO?

Outputs the data entered from port C (4 bit) of the 24-bit I/O port.

OUTPINPDIO?

Outputs the data entered from port D (4 bit) of the 24-bit I/O port.

OUTPINPEIO?

Outputs the data entered from port E (8 bit) of the 24-bit I/O port.

OUTPIRFORM?

Outputs the real part of the formatted data from the inactive channel.

OUTPIRTMEM?

Outputs the real part of the trace memory data from the inactive channel.

OUTPITMEM?

Outputs the trace memory data from the inactive channel. (Data format: real, imaginary)

OUTPLIMF?

Outputs the limit test results only for the failed points. (Data format: stimulus, result (always 1), upper limit, lower limit; Form 4)

OUTPLIML?

Outputs the limit test results for each point. (Data format: stimulus, result (0 for pass, 1 for fail, -1 for no test), upper limit, lower limit; Form 4)

OUTPLIMM?

Outputs the limit test result for the marker position. (Data format: stimulus, result (0 for pass, 1 for fail, -1 for no test), upper limit, lower limit)

OUTPMARK?

Outputs the active marker values. (Data format: marker value, marker aux. value, stimulus)

OUTPMAX?

Outputs the maximum value within the range specified with the ANARANG command. For details, refer to Appendix E. (Data format: maximum, stimulus)

OUTPMEAN?

Outputs the mean value within the range specified with the ANARANG command. For details, refer to Appendix E. (Data format: mean)

OUTPMEMO?

Outputs the memory data from the active channel. (Data format: real, imaginary)

OUTPMEMOT?

Outputs memory trace value on 16 points stimulus which is set by the STIMROUT command. If there are points that is not set by STIMROUT command, OUTPMEMOT? returns the value at 100 kHz. (Data format: real × 16)

OUTPMEMTP? *value*

Outputs the memory data at a specified point. (Data format: real, imaginary)

value 1 to "number of points"

STDTARBI

Defines the standard type to LOAD with an arbitrary impedance.

(ARBITRARY IMPEDANCE under CAL); Query)

STDTDELA

Defines the standard type as transmission line of specified length.

(DELAY/THRU under CAL); Query)

STDTLOAD

Defines the standard type as LOAD (termination).

(LOAD under CAL); Query)

STDTOPEN

Defines the standard type as an OPEN.

(OPEN under CAL); Query)

STDTSHOR

Defines the standard type as a SHORT.

(SHORT under CAL); Query)

STIDROUT{1-16} *value* [*suffix*]

Sets stimulus of data trace up to 16 for OUTPDATAT? query. To execute STIDROUT? query, pass a number as the parameter.

value 1 (kHz) to 300 (MHz)
suffix refer to "Suffix"

STIMROUT{1-16} *value* [*suffix*]

Sets stimulus of memory trace up to 16 for OUTPDATAT? query. To execute STIDROUT? query, pass a number as the parameter.

value 1 (kHz) to 300 (MHz)
suffix refer to "Suffix"

STODDISK

Selects internal flexible disk drive for mass storage device.

STODMEMO

Selects RAM disk drive for mass storage device.

STOP *value* [*suffix*]

Defines the stop value of the stimulus. ((STOP); Query)

Sets the stop frequency of a segment.

(STOP under MENU; Query)

value 1 (kHz) to 300 (MHz)

suffix refer to "Suffix"

STPSIZE *value* [*suffix*]

Specifies the frequency step for a list sweep table.

(STEP SIZE under MENU; Query)

value 0 to 299.999 (MHz)

suffix refer to "Suffix"

SWET *value* [s]

Manually sets the sweep time.

(SWEEP TIME under MENU; Query)

value 6.0×10^{-4} to 86,400 (s)

SWETAUTO

Automatically sets the sweep time.

(SWEEP TIME AUTO under MENU; Query)

SWPT *parameter*

Selects the sweep type. (Query)

<i>parameter</i>	<i>description</i>
LINF	Linear frequency
LOGF	Log frequency
LIST	Frequency list

TARL? *value*

Outputs stimulus of first found point which has value specified by parameter of this command from right of range which is set by ANARANG command. For more information, refer to Appendix E. (Data format: stimulus)

value 1 (kHz) to 300 (MHz)

suffix refer to "Suffix"

OUTPRESF?

OUTPRESF? searches maximum local-maximum (fs) and minimum local-minimum (fp) within specified range, then, searches x1 dB below points for both side from fs and x2 dB above points for both side from fp. The first point founded on the left-hand side of fs is fs1, and right-hand side is fs2. In a similar way, fp1 is first point found on the left-hand side of fp, and fp2 is right-hand point. See Figure E-19.

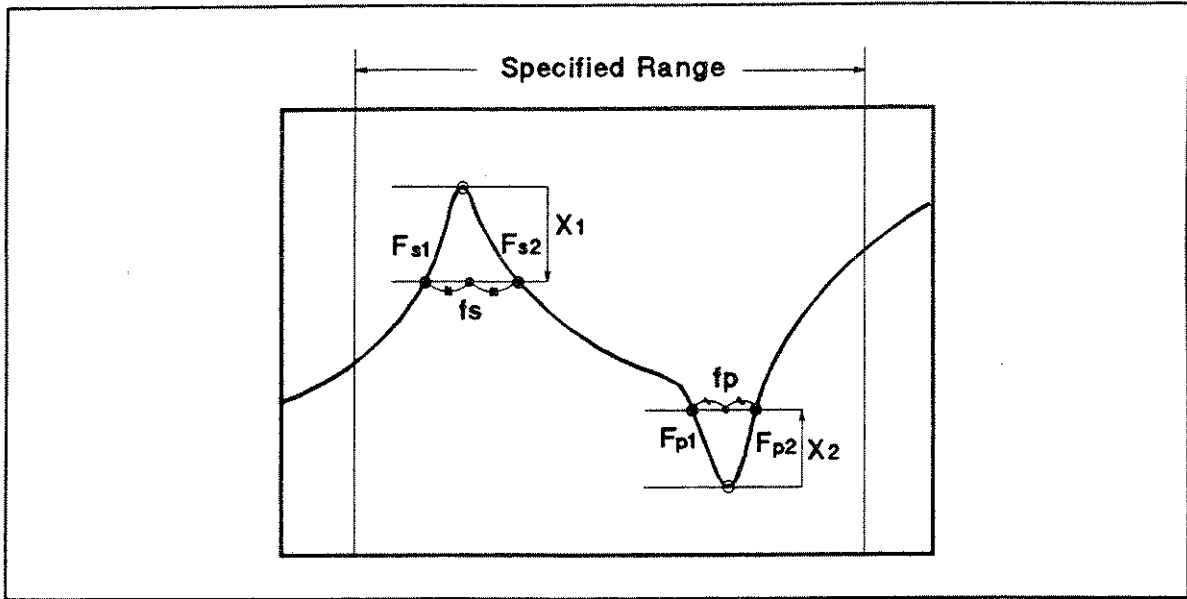

Figure E-19. OUTPRESF?

Equivalent Circuit Analysis Commands

The following commands make an equivalent circuit analysis for the measurement data and return the analysis result. The equivalent circuit analysis is made within the range specified by the ANARANG command. Following commands are only available when the polar format and admittance conversion is selected.

EQUCPARA?

The EQUCPARA? command makes a 4-device equivalent circuit analysis for the crystal resonator and returns equivalent circuit constants. The EQUCPARA? regards the following circuits as equivalent circuits:

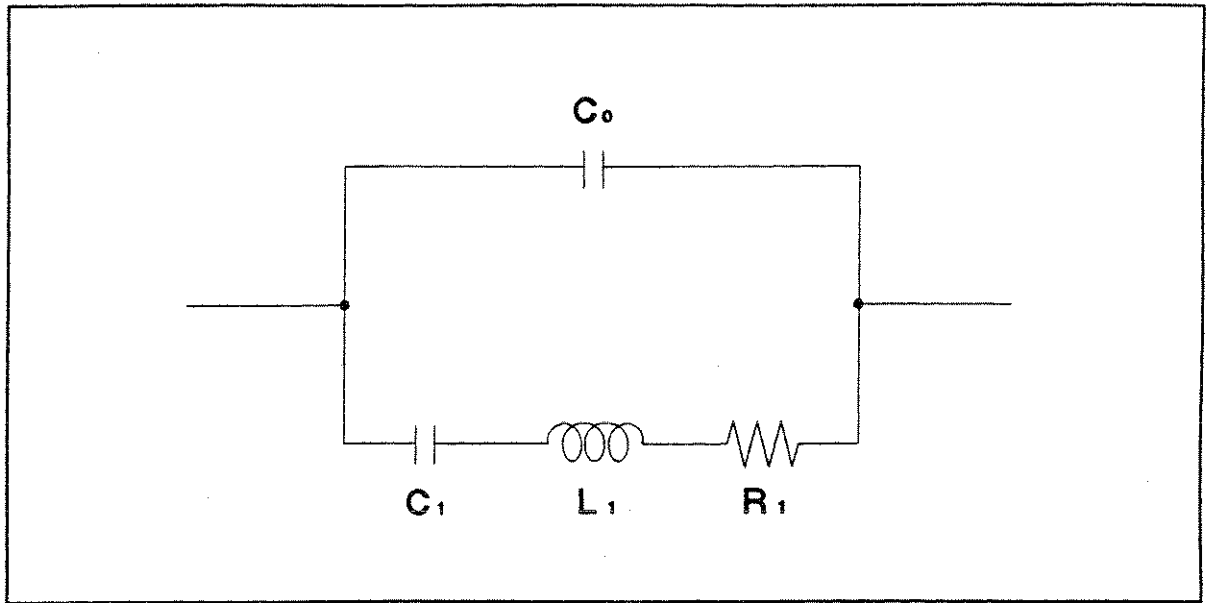

Figure E-20. Four-Device Equivalent Circuit for Crystal Resonator

Where,

- C_0 : Parallel capacity
- C_1 : Motional capacity
- L_1 : Motional inductance
- R_1 : Motional resistance

The EQUCPARA? command obtains the above constants in the following procedure:

1. Obtains the admittance characteristic circle diagram.
2. Obtains the susceptance (Bfs) and its frequency (fs) at the maximum conductance (Gmax) point.
3. Obtains frequencies f_1 and f_2 ($f_1 < f_2$) of two points where the conductance is half the maximum conductance (Gmax).
4. Assumes that the frequency at which the phase becomes 0° near the parallel resonance frequency is f_a .
5. Assumes that the frequency at which the phase becomes 0° near the series resonance frequency is f_r .
6. Calculates the constants using the above values and the following equations:

$$R_1 = \frac{I}{G_{max}}$$

$$L_1 = \left| \frac{Q \times R_1}{2\pi f_s} \right|$$

$$C_1 = \frac{1}{QR_1 \times 2\pi f_s}$$

$$C_0 = \left(\frac{f_r^2}{f_a^2 - f_r^2} \right)$$

Where,

$$Q = \left| \frac{f_s}{f_2 - f_1} \right|$$

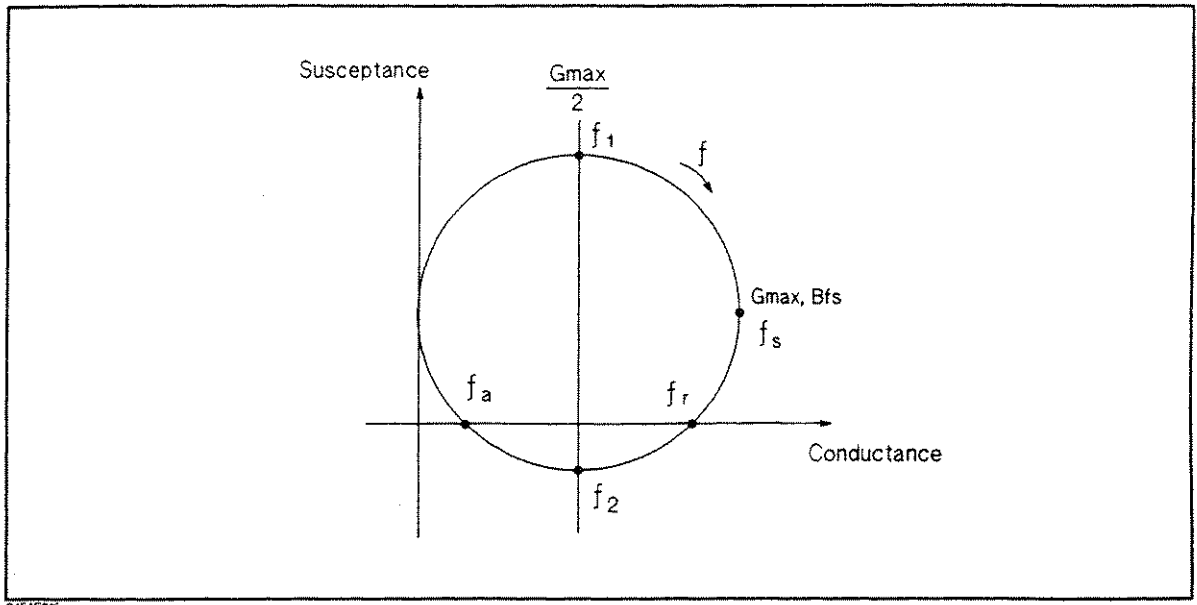

Figure E-21. Admittance Characteristic Chart

If there are no f_r and f_a points on the admittance chart, C_0 is calculated using the following equation:

$$C_0 = \frac{B f_s}{2\pi f_s}$$

EQUCPARS?

The EQUCPARS? command returns f_s , f_a , f_r , f_1 , and f_2 in addition to C_0 , C_1 , L_1 , and R_1 which are returned by the EQCUPARA? command. For more information on parameters, see "EQCUPARA?".



*

**HP 87510A
Gain-Phase Analyzer
Operation Manual**

MANUAL IDENTIFICATION

Model Number: HP 87510A
Date Printed: Dec. 1991
Part Number: 87510-90000

This supplement contains information for correcting manual errors and for adapting the manual to newer instruments that contains improvements or modifications not documented in the existing manual.

- To use this supplement
1. Make all ERRATA corrections
 2. Make all appropriate serial-number-related changes listed below

SERIAL PREFIX OR NUMBER MAKE MANUAL CHANGES

SERIAL PREFIX OR NUMBER MAKE MANUAL CHANGES

► New Item

ERRATA

Using HP Instrument BASIC part

Page 7-7, Using the 8-bit I/O Port in BASIC Programs (option 005 only)

Change the description as follows:

READIO(15,2) reads the 4-bit data from the 8-bit I/O port and returns it as a decimal value.

Page A-5, READIO

Change the table item as following:

Item	Description	Range
register number	numeric expression	0 to 800 (Select code 8) 2 to 4 (Select code 15) 2 (Select code 15: option 005 only)

NOTE

Manual change supplement are revised as often as necessary to keep manuals as current and accurate as possible. Hewlett-Packard recommends that you periodically request the latest edition of this supplement. Free copies are available from all HP offices. When requesting copies, quote the manual identification information from your supplement, or the model number and print date from the title page of the manual.



MANUAL CHANGES

HP 87510A Gain-Phase Analyzer Operation Manual

MANUAL IDENTIFICATION

Model Number: HP 87510A
Date Printed: Dec. 1991
Part Number: 87510-90000

This supplement contains information for correcting manual errors and for adapting the manual to newer instruments that contains improvements or modifications not documented in the existing manual.

To use this supplement

1. Make all ERRATA corrections
2. Make all appropriate serial-number-related changes listed below

SERIAL PREFIX OR NUMBER	MAKE MANUAL CHANGES
All	Chapter 1
3240J	Chapter 2-4

SERIAL PREFIX OR NUMBER	MAKE MANUAL CHANGES

► New Item

This manual change sheet includes following contents:

Errata for the *Operation Manual* Chapter 1
Supplemental information for the revision 2.0 or later Chapter 2 to 4

NOTE

Manual change supplement are revised as often as necessary to keep manuals as current and accurate as possible. Hewlett-Packard recommends that you periodically request the latest edition of this supplement. Free copies are available from all HP offices. When requesting copies, quote the manual identification information from your supplement, or the model number and print date from the title page of the manual.



Errata for Operation Manual

This chapter provides errata correction information of for the *Operation Manual*.

Function Reference Part

Page 2-4, Option Available

Change Item	To
Option 0B0, Delete Operation Manual	Option 009, Delete Operation Manual
Option 0B1, Extra Operation Manual	Option 910, Extra Operation Manual

Page C-8, Command for Checking Input to INPUT1

Change the description as follows:

INPT? command checks whether a pulse has been input to the INPUT1. Sending INPU? after a pulse is input to the INPUT1 will return 1. If no pulse has been input to the INPUT1, the return value will be 0. Once 1 is read, this value will be cleared. (Set to 0.)

HP-IB Programming Manual Part

Change as follows:

Page 3-46, OUTPTESS? value

Outputs the specified test number's result. For more information, refer to the *Service Manual*. (Under SERVICE MENU under **SYSTEM**)

value 0 to 54

Page 3-65, TARL? value

Output stimulus of the first found point which has a value specified by the parameter of this command for left direction from the right edge of analysis range which is set by the ANARANGE command. For more information, see Appendix E. (Data format: stimulus)

value -5.0×10^5 to 5.0×10^5 (dB) (Log mag format)
 -5.0×10^5 to 5.0×10^5 (deg) (Phase and Expanded phase formats)
 -5.0×10^5 to 5.0×10^5 (s) (Delay format)
 -5.0×10^5 to 5.0×10^5 (Units) (Polar, Lin mag, Real, and Imaginary formats)

suffix refer to "Suffix"

Page 3-65, TARR value

Output stimulus of the first found point which has value specified by parameter of this command for right direction from the left edge of analysis range which is set by ANARANGE command. For more information, see Appendix E. (Data format: stimulus)

value -5.0×10^5 to 5.0×10^5 (dB) (Log mag format)
 -5.0×10^5 to 5.0×10^5 (deg) (Phase and Expanded phase formats)
 -5.0×10^5 to 5.0×10^5 (s) (Delay format)
 -5.0×10^5 to 5.0×10^5 (Units) (Polar, Lin mag, Real, and Imaginary formats)

suffix refer to "Suffix"

Page 3-67, *TST?

Executes a power-on self test and returns the test result.

Page E-13, OUTPXFL?

Change Figure E-14 to the following figure:

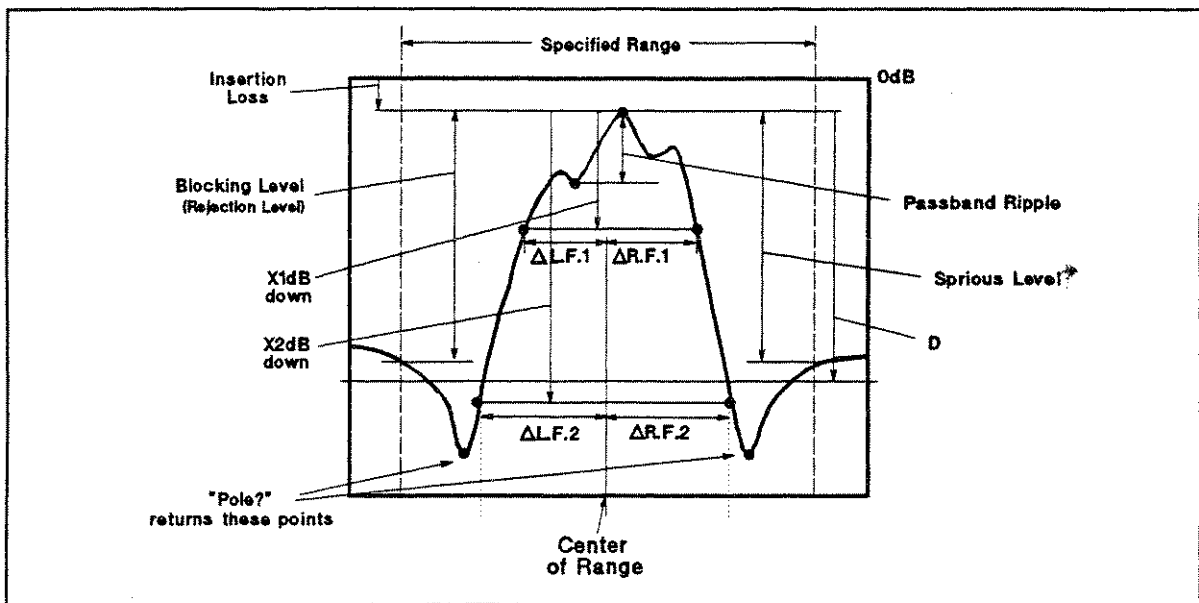

Figure E-14. OUTPXFL?

Page E-14, OUTPCFIL?

Change Figure E-15 to the following figure:

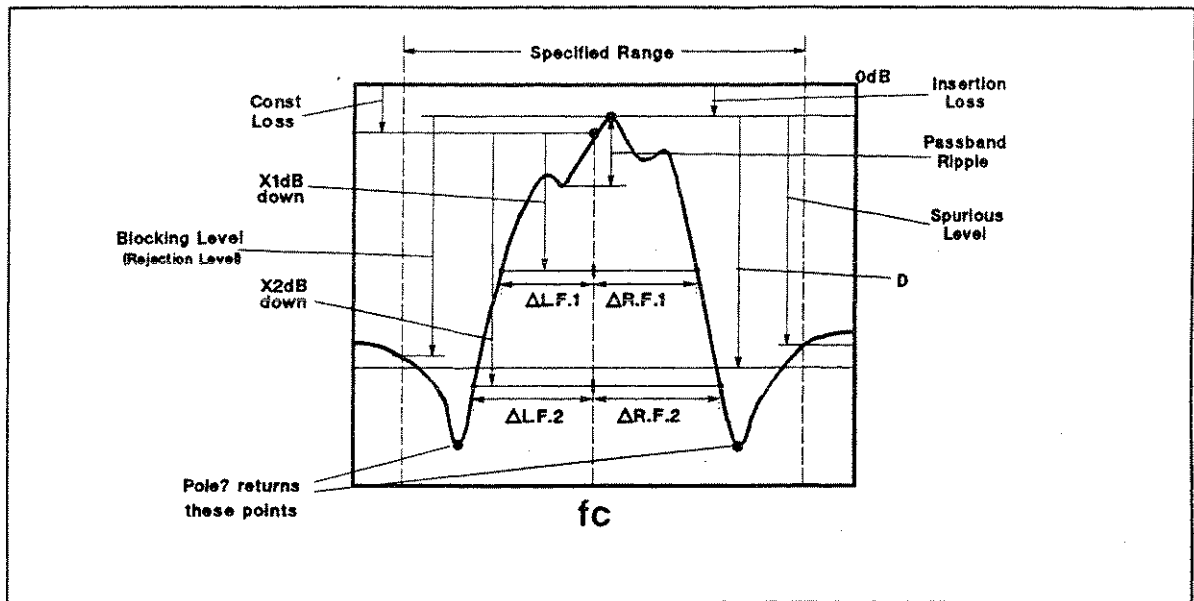

Figure E-15. OUTPCFIL?

Page G-2, One-Point Correction

Add a following line to the sample program:

```
185 OUTPUT @Hp87510;"RECCOFF" Turn OFF the receiver correction.
```

Note



The notation, *svc*, is displayed on the left of the grid. This is not an obstacle to the operation. To turn off this notation, execute the following line:

```
OUTPUT @Hp87510;"RECCON" Turn ON the receiver correction.
```

Using HP Instrument BASIC part

Change Figure 10-14 to the following figure:

```
10 INPUT "ENTER FILE NAME (without EXT.)",File_name$
20 MASS STORAGE IS ":INTERNAL" ! Select flexible disk drive
21                               ! When you want to use RAM disk,
22                               ! change ":INTERNAL" to ":MEMORY"
30 DIM Dat(1:201,1:2)           ! Assume data size of "Dat" is 201 points
40 File_name$=File_name$&"_D" ! Add extension "_D" to filename
41                               ! When you want to use DOS format,
42                               ! change extension "_D" to ".DAT"
50 ASSIGN @File TO File_name$ ! Open target file
60 ENTER @File USING "17X,#" ! Skip the data header
70 INTEGER Nop                 ! Declare the variable, "Nop"
80 ENTER @File;Nop             ! Skip a NOP data of header
90 ENTER @File USING "4X,#" ! Skip the header
100 ENTER @File;Dat(*)         ! Load data from file
110 ASSIGN @File TO *          ! Close file
120 PRINT Dat(*)              ! Print data
130 END
```

Figure 10-14. Loading Trace Data

Manual Change for Function Reference

Page 2-4, Options Available

Add following items:

Option 010, Extended Output Power Range

This option increases the output power range and adds power sweep capability.

Page 3-6, Specifications When Option is Installed

Add following item:

Specifications When Option 010 Extended Output Power Range is Installed

■ Output Power Characteristics

Range	-45 to +15 dBm
Resolution	0.2 dB
Level Accuracy (at 23±5°C, 0 dBm output level, 50 MHz)	±1 dB
Flatness (at 23±5°C, relative to 0 dBm output level at 50 MHz)	
100 k to 300 kHz	+3, -5 dB
300 k to 100 MHz	+2.5, -4.5 dB
100 M to 300 MHz	+3, -5 dB
Linearity (at 23±5°C, relative to 0 dBm output level at 50 MHz)	±1 dB

All of the above data is from the RF OUT 1 port when the RF OUT 2 port is terminated.

■ Spectral Purity Characteristics

Harmonics (at +15 dBm output level)	< -20 dBc
---	-----------

■ Power Sweep Characteristics

Maximum Span	60 dB
Resolution	0.1 dB

Page 8-2, **MENU** Key

Change Figure 8-2 to the following figure:

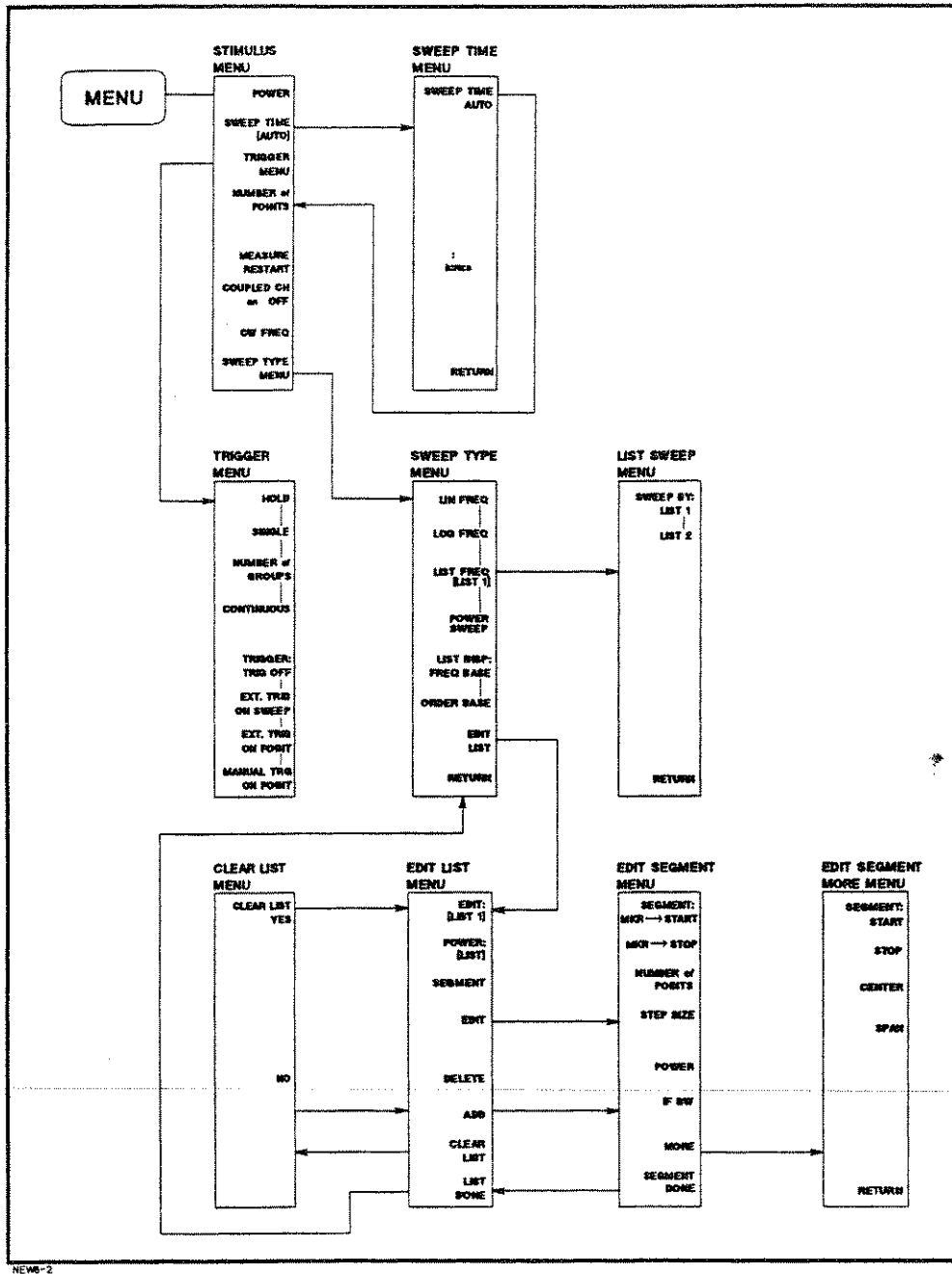

Figure 8-2. Softkey Menus Accessed from the **MENU** Key

Page 8-3, Stimulus Menu

Change Figure 8-3 to the following figure:

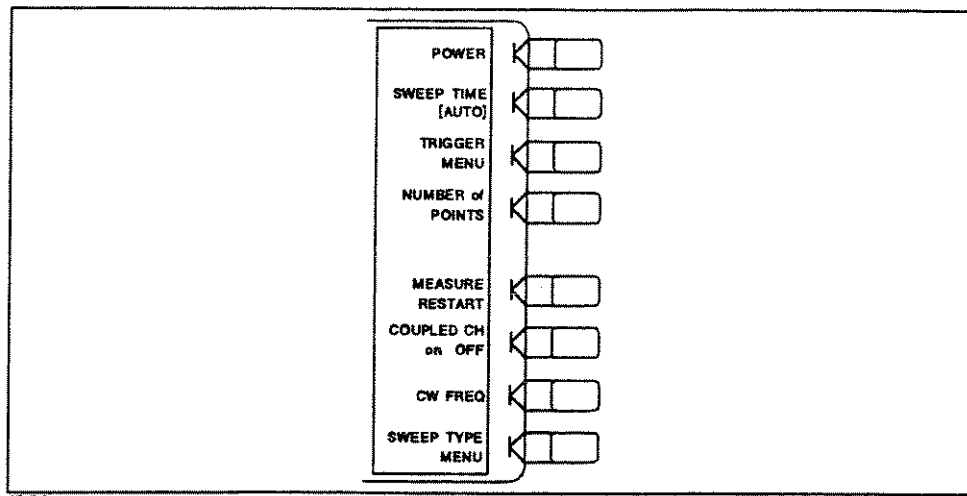

Figure 8-3. Stimulus Menu

Change as follows:

POWER (POWE) makes the power level the active function and activates the power menu, which sets the output power level. The allowable power range is -15 dBm to $+5$ dBm. When the option 010 is installed, the allowable power range becomes -50 dBm to $+20$ dBm. Default setting is 0 dBm. Setting resolution is 0.1 dBm.

Add following description:

CW FREQ (CWFREQ) sets the frequency for power sweep. (Option 010 only)

Page 8-7, Sweep Type Menu

Change as follows:

Four sweep types are available:

- Linear frequency sweeps in Hz
- Logarithmic frequency sweeps in Hz
- Power sweeps in dBm (Option 010 only)
- List frequency sweep in Hz. Two independent frequency sweep lists are available.

Change Figure 8-6 to the following figure:

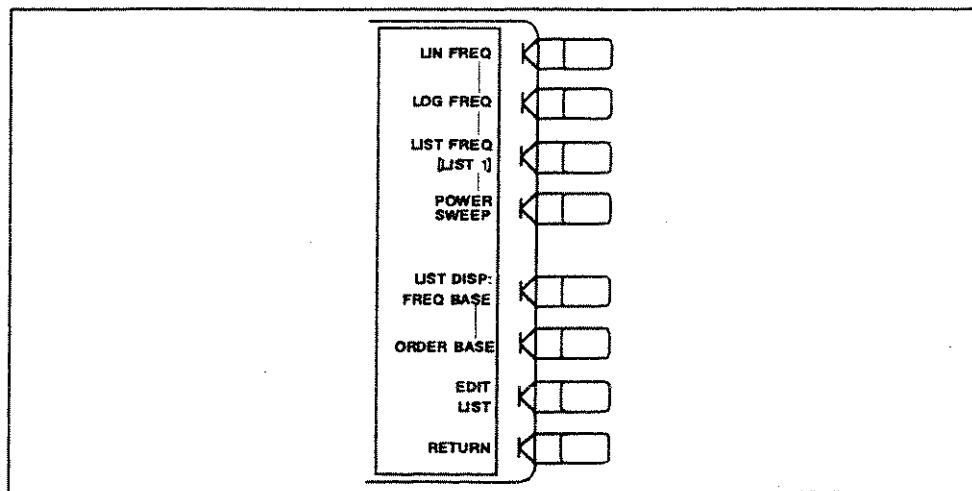

Figure 8-6. Sweep Type Menu

Add following description:

POWER SWEEP (POWS) activates a power sweep mode that characterizes power-sensitive DUTs. In this mode, power is swept at a single frequency, from a start power value to a stop power value, selected using the **START** and **STOP** keys and the entry block. This feature is convenient for measurements like gain compression or AGC (automatic gain control) slope. To set the power sweep frequency, use **CW FREQ** in the stimulus menu.

In power sweep, the entered sweep time may be automatically changed if it is less than the minimum time required for the current configuration (number of points, IF bandwidth, etc.).

This function is only available when the option 010 is installed.

Page 8-9, Edit List Menu

Change Figure 8-8 to the following figure:

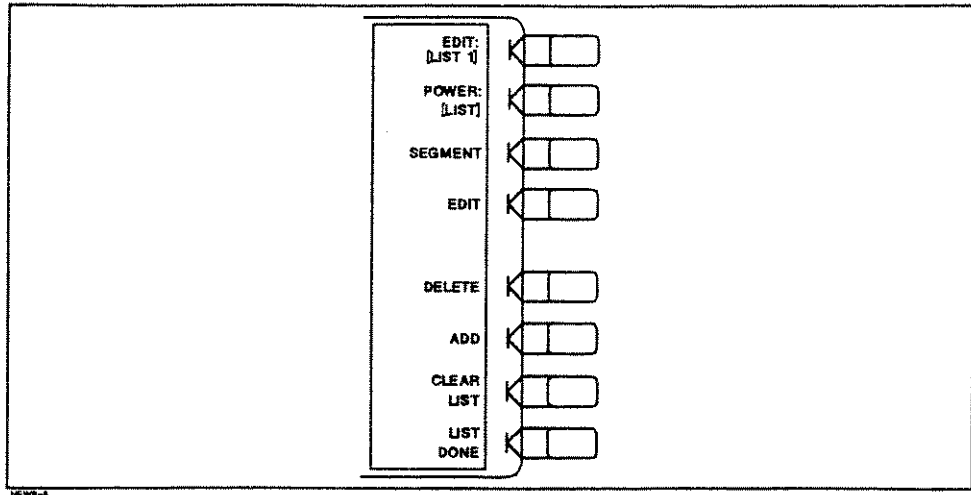

Figure 8-8. Edit List Menu

EDIT: [LIST 1] (EDITLIS1) or [LIST 2] (EDITLIS2) toggles between LIST 1 and LIST 2 for editing.

POWER: [LIST] (POWL) or [FIXED] (POWF) toggles the power setting being used when list sweep is performed. [LIST] selects the power setting in the list table, and [FIXED] selects the power set by **MENU** POWER key.

Page 8-10, Edit Segment Menu

Change as follows:

SEGMENT-POWER (POWE) sets power level in a list for segment by segment. The allowable range is -15 dBm to +5 dBm. When the option 010 is installed, the allowable power range becomes -50 dBm to +20 dBm.

Page 9-2, **MEAS** Key

Change Figure 9-2 to the following figure:

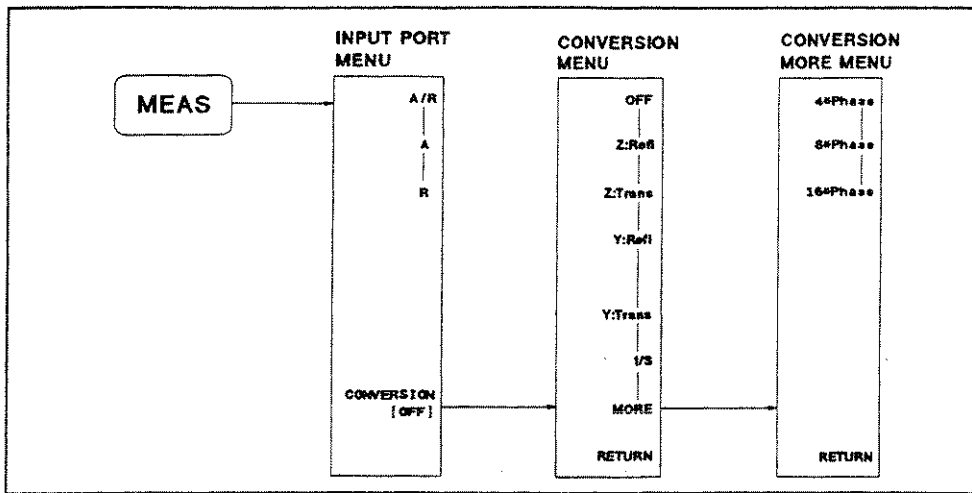

Figure 9-2. Softkey Menus Accessed from the **MEAS** Key

Page 9-3, Conversion Menu

Change as follows:

This menu converts the measured reflection or transmission data to the equivalent complex impedance (Z) or admittance (Y) values. This is not the same as a two-port Y or Z parameter conversion, as only the measured parameters are used in the equations. Two simple one-port conversions are available, depending on the measurement configuration.

An S_{11} or S_{22} trace measured as reflection can be converted to an equivalent parallel* impedance or admittance using the model and equations shown in Figure 9-4A.

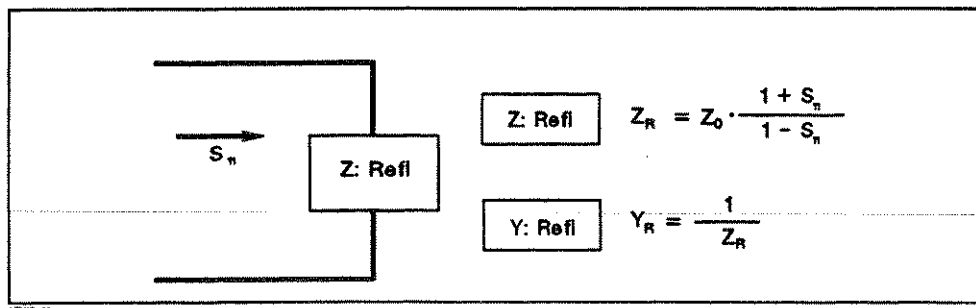

Figure 9-4A. Reflection Impedance and Admittance Conversions

In a transmission measurement, the data can be converted to its equivalent series impedance or admittance using the model and equations shown in Figure 9-4B.

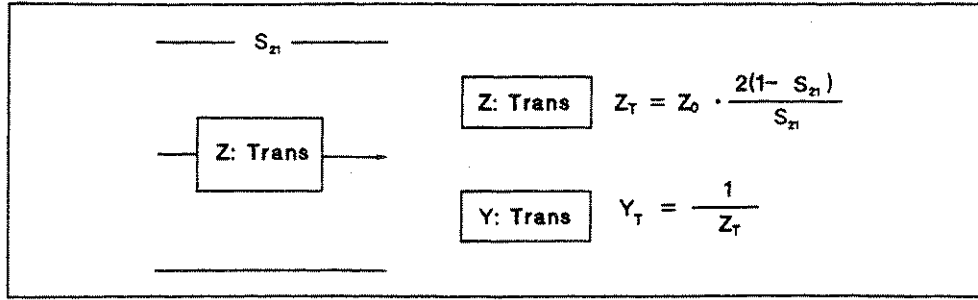

Figure 9-4B. Transmission Impedance and Admittance Conversions

Avoid using delay format for displaying Z and Y conversions, as these formats are not easily interpreted.

In all conversions except for “1/S”, marker values are impedance values in Ω units for Z conversions, or admittance values in S units for Y conversions in any format. The unit is displayed as “U” on CRT.

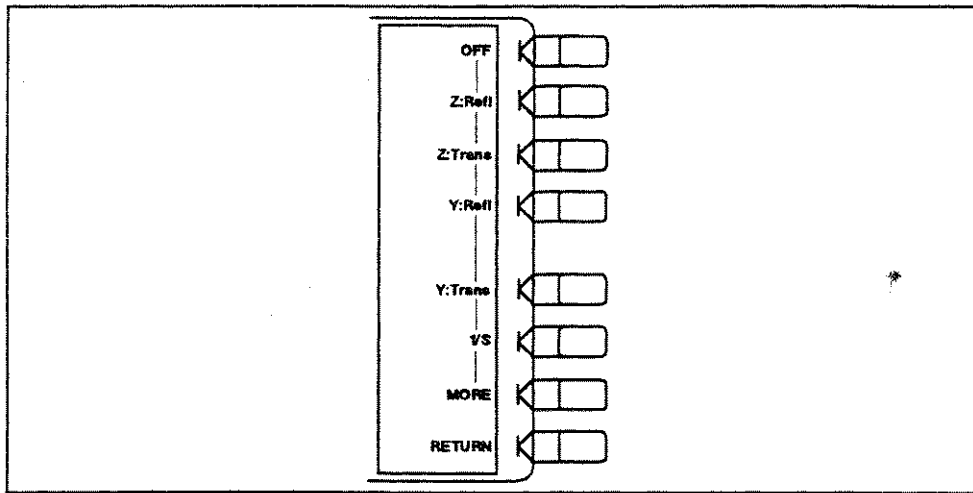

Figure 9-5A. Conversion Menu

OFF (CONVOFF) turns off all the parameter conversion operations.

Z: Refl (CONVZREF) converts the reflection data to its equivalent impedance values.

Z: Trans (CONVZTRA) converts the transmission data to its equivalent impedance values.

Y: Refl (CONVYREF) converts the reflection data to its equivalent admittance values.

Y: Trans (CONVYTRA) converts the transmission data to its equivalent admittance values.

1/S (CONV1DS) expresses the data in inverse S-parameter values, ideal for use in amplifier and oscillator design.

MORE provides the Conversion More menu described in the next section.

RETURN returns to the previous menu, the input ports menu.

Conversion More Menu

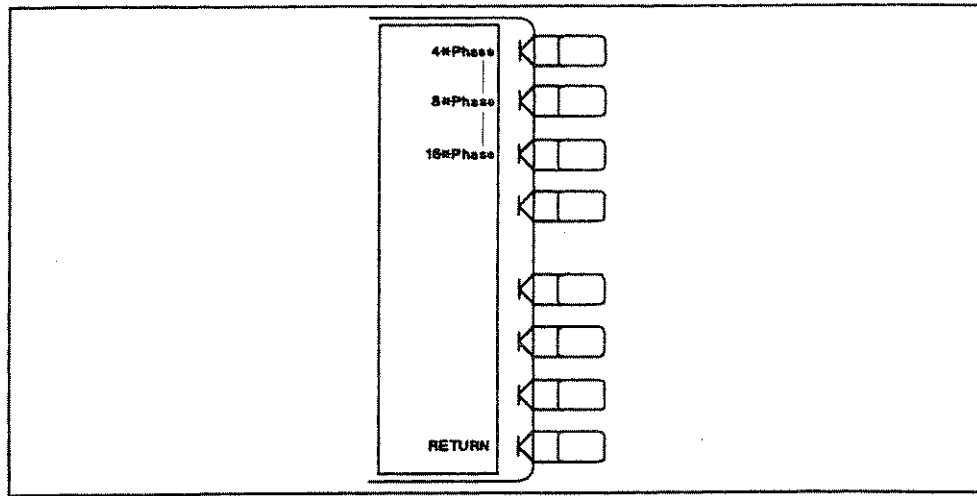

Figure 9-5B. Conversion More Menu

4*phase (CONVMP4) multiplies phase data by a factor of 4.

8*phase (CONVMP8) multiplies phase data by a factor of 8.

16*phase (CONVMP16) multiplies phase data by a factor of 16.

RETURN returns to the conversion menu.

Page 9-25, Special Function Menu

EQUIVALENT CKT (EQUCPARA?) derives parameters for the equivalent circuit used for a crystal resonator, within the frequency range specified by ANALY MIN and ANALY MAX. The equivalent circuit is shown in Figure 9-38.

When a measured data is not applicable for the equivalent circuit model, then "0" will be returned for all parameters.

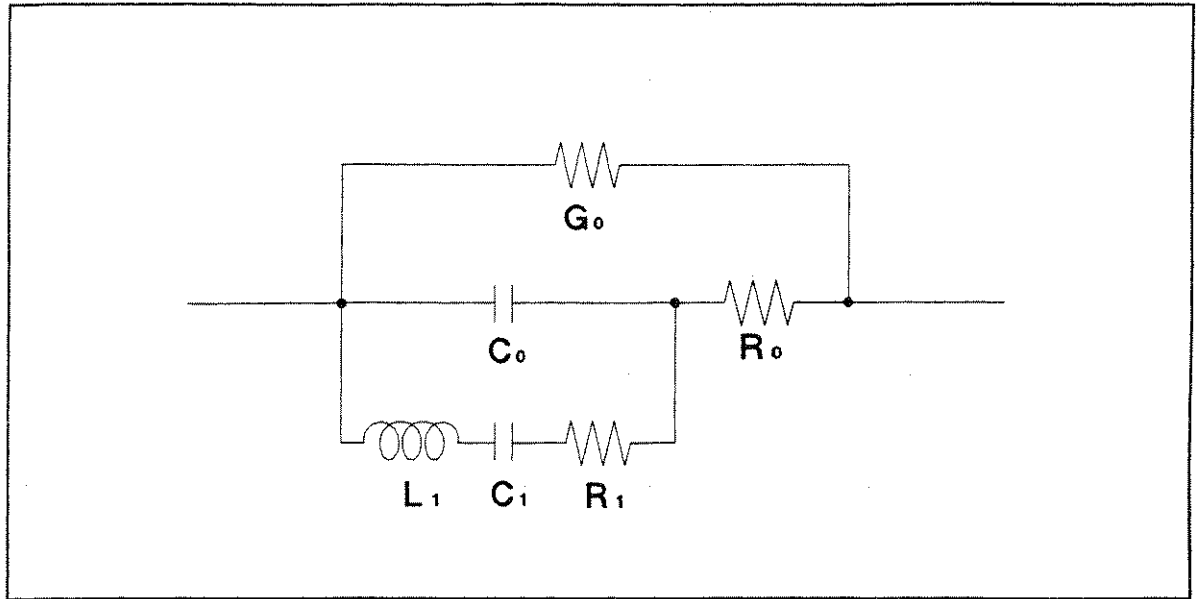

CASME501

Figure 9-38. Six-Device Equivalent Circuit for Crystal Resonator

Page 14-2, File Type and Data Saved

Add following note:

Note



It is not possible to recall the instrument status file that is saved by a revision 2.0 instrument by a revision 1.0 instrument. The revision 2.0 can read the instrument setting file of the revision 1.0. When you use the same instrument setting file for the revision 1.0 and 2.0, use the setting file that is saved by the revision 1.0.

Page B-1, Preset State

Add following item to table B-1:

Table B-1. Preset Conditions

Operating Parameter	Initialization Method	
	Power-On	PRESET key
Frequency List		
Power Setting	LIST	LIST

Page E-1. Stimulus Block

Change Figure E-1 to the following figure:

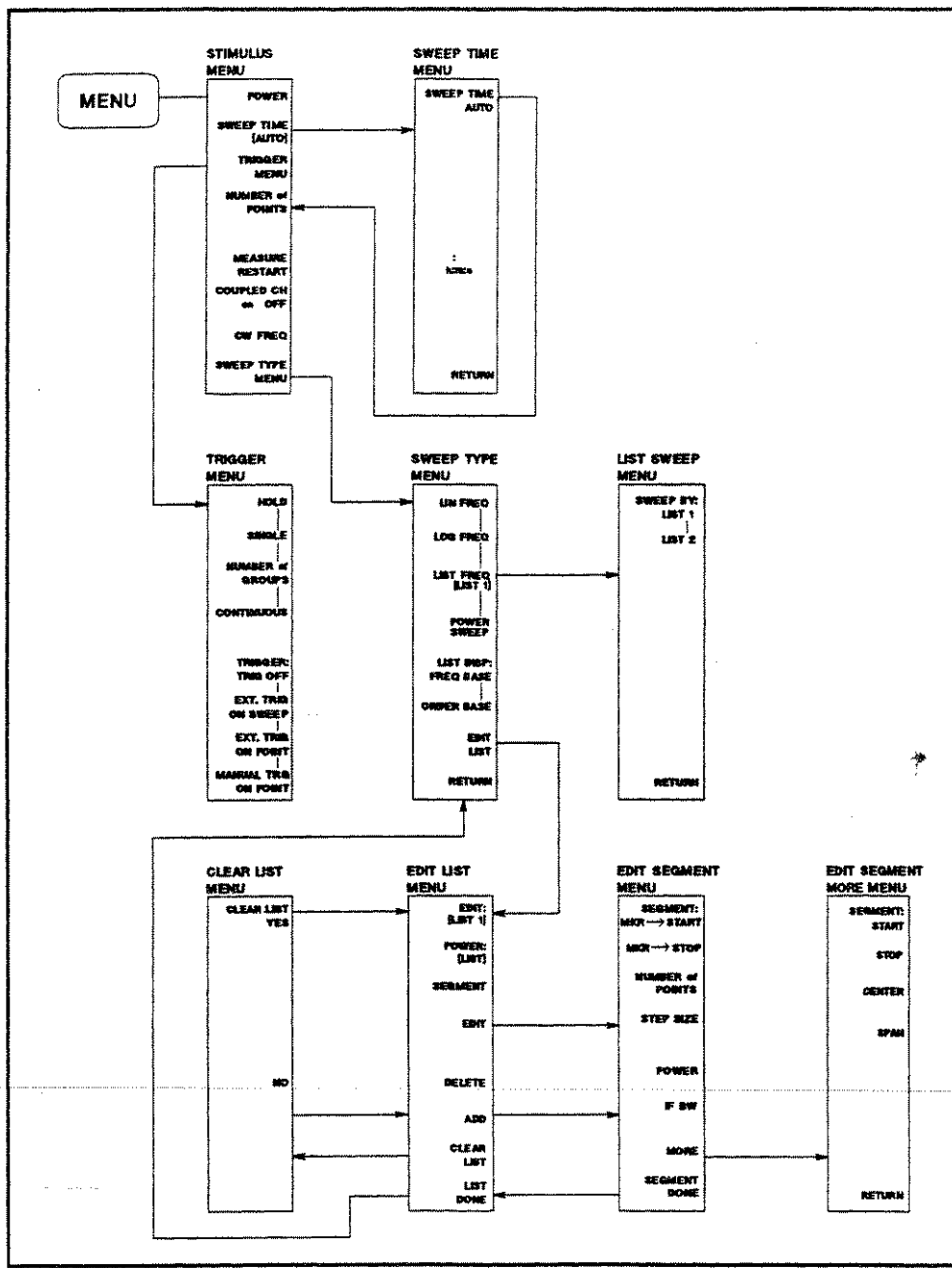

Figure E-1. **MENU** Key

Change Figure E-2 to the following figure:

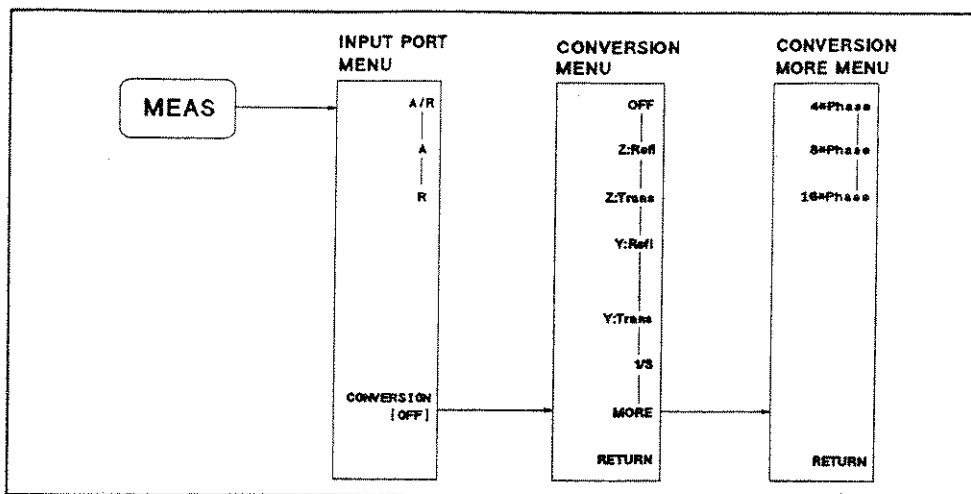

Figure E-2. **MEAS** Key

Page Message-1, Error Messages

Add following error messages to Error Message List.

31 NOT AVAILABLE FOR THIS FORMAT

Command, DISPDATM, is not valid when the format is either LOG MAG & Phase, or LOG MAG & Delay.

204 POWER ON TEST FAILED

The power on test is failed.

246 INSUFFICIENT MEMORY

A large COM variable has been made by the Instrument BASIC and the system memory is not large enough for the operation.

BUS ERROR

Instrument needs the adjustment or the repair. Contact your local Hewlett-Packard service center or sales office.

ADDRESS ERROR

Instrument needs the adjustment or the repair. Contact your local Hewlett-Packard service center or sales office.

ILLEGAL INSTRUCTION

Instrument needs the adjustment or the repair. Contact your local Hewlett-Packard service center or sales office.

DIVIDE BY ZERO

Instrument needs the adjustment or the repair. Contact your local Hewlett-Packard service center or sales office.

PRIVILEGE VIOLATION

Instrument needs the adjustment or the repair. Contact your local Hewlett-Packard service center or sales office.

FATAL ERROR: can't alloc memory

Instrument needs the adjustment or the repair. Contact your local Hewlett-Packard service center or sales office.

FP ERROR any OCCURRED , IN any AT xxxxxxxxH

This message is displayed when the HP 87510A, or a user operation has any problem. Contact your local Hewlett-Packard service center or sales office.

FATAL ERR:No response from A2 CPU, ACK not asserted

Instrument needs the adjustment or the repair. Contact your local Hewlett-Packard service center or sales office.

FATAL ERR:No response from A2 CPU, ACK not negated

Instrument needs the adjustment or the repair. Contact your local Hewlett-Packard service center or sales office.

FATAL ERROR:duplicate sweep trigger

Instrument needs the adjustment or the repair. Contact your local Hewlett-Packard service center or sales office.

FATAL ERROR occurred on A2 CPU

Instrument needs the adjustment or the repair. Contact your local Hewlett-Packard service center or sales office.

Manual Changes for HP-IB Command Reference

Changed HP-IB Commands

The following commands have been changed from firmware revision 2.0:

EQUCPARA?
 EQUCPARS?
 POWE *value*

EQUCPARA?

Executes the six-device equivalent circuit analysis for a resonator, then outputs parameters, C_0 , C_1 , L_1 , R_1 , G_0 , and R_0 . For more information, refer to "EQUCPARA?" in Chapter 4. (Data format: C_0 , C_1 , L_1 , R_1 , G_0 , R_0)

(**EQUIVALENT GKT** under **SPCL FCTN**); Query only)

EQUCPARS?

Executes the six-device equivalent circuit analysis for a resonator, then outputs parameters, C_0 , C_1 , L_1 , R_1 , f_s , f_a , f_r , f_1 , f_2 , G_0 , and R_0 . For more information, refer to "EQUCPARS?" in Chapter 4. (Data format: C_0 , C_1 , L_1 , R_1 , f_s , f_a , f_r , f_1^* , f_2^* , G_0 , R_0)

* $f_1 < f_2$

POWE *value* [dBm]

Sets the source output level.

(**POWER** under **MENU**); Query)

value -15 to +5 (dBm)
 -50 to +20 (dBm) (Option 010 only)

New HP-IB Commands

The following commands have been added to the HP 87510A with firmware revision 2.0.

ATTN{0DB|20DB|40DB}
CONVYREF
CONVZREF
CWFREQ *value*
EQUCO? *value*
EQUM *value*
ERRH{ON|OFF}
OUTPCERR?
POWF
POWL
POWO?
POWS
SERM?

ATTN{0DB|20DB|40DB}

Sets the power attenuator value to 0 dB, 20 dB or 40 dB.

(Under SERVICE MENU under **SYSTEM**)

CONVYREF

Converts the reflection data to its equivalent admittance values.

(Y: Ref1 under **MEAS**; Query)

CONVZREF

Converts the reflection data to its equivalent impedance values.

(Z: Ref1 under **MEAS**; Query)

CWFREQ *value* [*suffix*]

Sets the frequency for power sweep. (Option 010 only)

(CWFREQ under **MENU**; Query)

value 10^3 to 3.0×10^8 (Hz)
suffix See "Suffix" of the *HP-IB Programming Manual*.

EQUCO? *value* [*suffix*]

Returns a C_0 at the specified frequency. For more information about EQUCO?, see "EQUCO? *value*" in Chapter 4.

value 10^3 to 3.0×10^8 (Hz)
suffix See "Suffix" of the *HP-IB Programming Manual*.

EQUM *value*

Specifies how many points are used for an approximation of a circle for EQUCPARA? and EQUCPARS? command. The default value is 8. For a detail information about EQUM, refer to "EQUCPARA?" in Chapter 4.

value Integer: 2 to 801

ERRH{ON|OFF}

Select whether halting or rebooting instrument when a system error has occurred. If ERRHON is sent, instrument will stop all functions when the system error is occurred. If ERRHOFF is sent, instrument will reboot when the system error is occurred. Default setting is ERRHOFF. For more information, see *Service Manual*.

OUTPCERR?

Outputs ceramic resonator parameters. For information about each parameter, see "OUTPCERR?" in Chapter 4. (Data format: G_r , F_r , G_a , F_a , rpl_1 , rpl_2 , rpl_3)

POWF

Selects the fixed power which is set by **MENU POWER** key or POWE command when a list sweep being performed. To use a power set in list table, send a POWL command. The default setting is POWL. (**POWER [FIXED]** under **MENU**); Query)

POWL

Selects the power which is set in the list table when a list sweep being performed. You can also select fixed power setting which is set in **MENU POWER** by sending a POWF command. The default setting is POWL. (**POWER [LIST]** under **MENU**); Query)

POWO?

Verifies whether the option 010 extended output power range is installed or not. If power sweep options is installed, query operation returns a string; "010". If not installed, query returns "STD". (Query only)

POWS

Select the sweep type to the power sweep. (Option 010 only)

(**POWER SWEEP** under **MENU**); Query)

SERM?

Verifies whether the service mode is ON or OFF. If the service mode of channel 1 and 2 is turned off, a SERM? returns 0, or other case, returns 1. This command has no correspondent softkey. For more information, see *Service Manual*. (Query only)



Added and Changed Waveform Analysis Commands

This chapter provides a brief description for the waveform analysis commands which are added to the firmware revision 2.0. This chapter corresponds to the appendix E of the *HP-IB Programming Manual*.

Following commands are added or changed from revision 2.0:

- EQUCPARA?
- EQUCPARS?
- EQU
- EQUCO?
- OUTPCERR?

EQUCPARA?

Outputs six-device equivalent circuit parameters of the crystal resonator; C_0 , C_1 , L_1 , R_1 , G_0 , R_0 .

Syntax

EQUCPARA?

This command is query only.

Query Response

C_0 , C_1 , L_1 , R_1 , G_0 , R_0

Each term represents equivalent circuit as shown below:

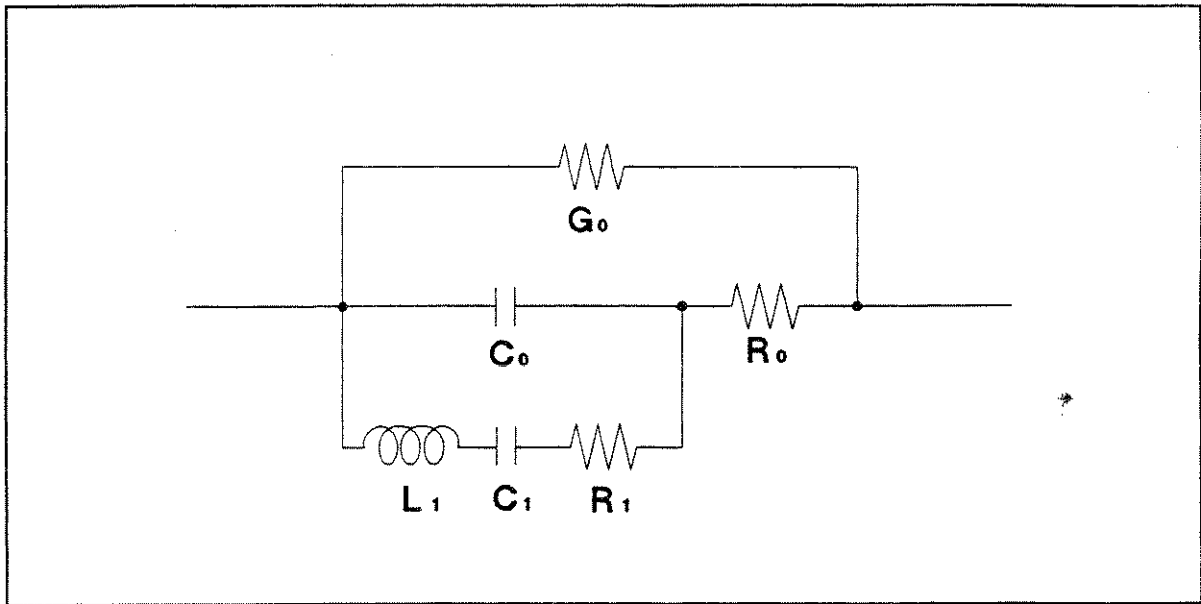

Figure 4-1. Six-Device Equivalent Circuit of Resonator

Descriptions

When EQUCPARA? is sent, instrument performs followings:

1. Obtains the admittance characteristic circle diagram.
2. Obtains the maximum conductance (G_{max}).
3. Obtains frequencies f_1 and f_2 ($f_1 < f_2$) of two points where the conductance is half the maximum conductance (G_{max}).
4. Calculate f_s by $f_s = \sqrt{f_1 \times f_2}$.
5. Obtains susceptance B_{fs} at f_s .
6. Calculate ω_s by $\omega_s = 2 \times \pi \times f_s$.
7. Assumes that the frequency at which the phase becomes 0° near the parallel resonance frequency is f_a , and obtains its conductance G_a .
8. Calculate ω_a by $\omega_a = 2 \times \pi \times f_a$.

9. Assumes that the frequency at which the phase becomes 0° * near the series resonance frequency is f_r .
10. Calculates the constants using the above values and the following equations:

$$\begin{aligned}
 Q_s &= \frac{f_s}{f_2 - f_1} & C_0' &= \frac{B_1 + B_2}{2\omega_s} \\
 L_1 &= \frac{Q_s}{\omega_s G_{max}} & R_1 &= \frac{C_0'}{C_0 G_{max}} \\
 C_1 &= \frac{G_{max}}{\omega_s Q_s} & R_0 &= \frac{1}{G_{max}} - R_1 \\
 C_0 &= \frac{B f_s}{\omega_s} & G_0 &= G_a - \frac{R_1 \omega_a^2 C_0^2}{1 + R_0 R_1 \omega_a^2 C_0^2}
 \end{aligned}$$

* EQUCPARA? interpolates the 0° phase points even if it does not exist in measured data.

If the number of points between the maximum peak point (f_{Bmax}) and the minimum peak point (f_{Bmin}) of the conductance is less than 10 points, EQUCPARA? approximates an admittance circle. The circle approximation can be performed if there are 3 points for analyze. You can specify how many points are used for circle approximation by using EQUM command for reducing the analysis time.

If EQUCPARA? fails a circle approximation, 0 will be return for all parameters.

If there are only 2 points for analysis, EQUCPARA? returns four-device equivalent circuit parameters. In this case, EQUCPARA? returns 0 for G_0 and R_0 .

If there is only 1 point for analysis, EQUCPARA? returns 0 for all parameters.

EQUM value

Specifies how many points are used for an approximation of a circle for EQUCPARA? and EQUCPARS? command. EQUCPARA? (or EQUCPARS?) thins the measured points out for the specified points, then make circle approximation. When the EQUM parameter is set greater than the number of points, EQUCPARA? uses all points for the circle approximation. Default value is 8.

value 2 to 801

Notes

This command is only available when the LOG MAG & Phase, or Polar format is selected. If the other format is selected, 0 will be returned for query response.

This command can be invoked with the EXECUTE command of Instrument BASIC.

Example

For the external controller:

10	OUTPUT 717;"POLA"	<i>Set to POLAR format.</i>
100	OUTPUT 717;"EQUCPARA?"	<i>Send the EQUCPARA? query to the HP 87510A.</i>
110	ENTER 717;C0,C1,L1,R1,GO,RO	<i>Receive the equivalent circuit parameters.</i>
120	PRINT "C0=",C0,"C1=",C1	<i>Display the equivalent circuit parameter</i>
130	PRINT "L1=",L1,"R1=",R1	<i>on the CRT.</i>
140	PRINT "GO=",GO,"RO=",RO	
150	END	

EQUCPARA?

For Instrument BASIC:

10	OUTPUT 800;"POLA"	<i>Set to POLAR format.</i>
20	EXECUTE "SING"	<i>Make a single sweep.</i>
100	WRITEIO 8,0;4	<i>Put the parameter of EQU on a register.</i>
101	!	<i>You must put the command parameter on the register</i>
102	!	<i>before you use the EXECUTE command.</i>
110	EXECUTE "EQU"	<i>Invoke the EQU command.</i>
111	!	<i>The EXECUTE runs the command faster</i>
112	!	<i>than the OUTPUT statement</i>
120	EXECUTE "EQUCPARA?"	<i>Invoke the EQUCPARA? query.</i>
130	CO=READIO(8,0)	<i>Read the first return value from the register.</i>
131	!	<i>HP 87510A returns the query response</i>
132	!	<i>to the register.</i>
140	C1=READIO(8,1)	<i>Read the second return value.</i>
150	PRINT "CO=",CO,"",C1=",C1	<i>Display the equivalent circuit parameters.</i>
160	L1=READIO(8,2)	<i>Read the third return value.</i>
170	R1=READIO(8,3)	<i>Read the fourth return value.</i>
180	PRINT "L1=",L1,"",R1=",R1	<i>Display the rest of query response.</i>
190	END	

EQUCPARS?

Outputs six-device equivalent circuit parameters of the crystal resonator; C_0 , C_1 , L_1 , R_1 , f_s , f_a , f_r , f_1^* , f_2^* , G_0 , R_0 .

Syntax

EQUCPARS?

Query Response

C_0 , C_1 , L_1 , R_1 , f_s , f_a , f_r , f_1^* , f_2^* , G_0 , R_0

* $f_1 < f_2$

For information about each parameter, refer to "EQUCPARA?".

Notes

This command is only available when the LOG MAG & Phase, or Polar format is selected. If the other format is selected, 0 will be returned for query response.

This command can be invoked with the EXECUTE command of Instrument BASIC.

EQUCO?

Returns C_0 of the equivalent circuit of the resonator at specified frequency.

Syntax

EQUCO? *value* [*suffix*]

Where,

value 10^3 to 3.0×10^8 (Hz)
suffix HZ (KHZ, MHZ, GHZ are also available)

This command is query only.

Query Response

C_0

Description

C_0 is calculated by using the following equation:

$$C_0 = \frac{B_s}{\omega_s}$$

Where,

B_s Imaginary part on f_s
 ω_s $2 \times \pi \times f_s$
 f_s Frequency which is specified as command parameter

If Z-conversion is selected, C_0 is calculated by using following equations:

$$C_0 = \frac{-1}{B_s \times \omega_s}$$

Notes

This command is only available when LOG MAG & Phase or Polar format is selected. If another format is selected, 0 will be returned. If the specified frequency is out of analysis range, 0 will be returned.

If B_s is 0 when the Z-conversion is activated, EQUCO? returns 0.

This command can be invoked with the EXECUTE command of Instrument BASIC.

Example

For the external controller:

```
100 OUTPUT 717;"EQUCO? 100MHZ"    Query  $C_0$  at 100 MHz.  
110 ENTER 717;CO                    Receive the returned  $C_0$ .  
120 PRINT "CO=",CO                  Display  $C_0$  on the CRT.  
130 END
```

For Instrument BASIC:

```
100 WRITEIO 8,0;1.E+8 Put the command parameter, 100 MHz, on the register.
110 EXECUTE "EQUCO?" Invoke the EQUCO? query.
120 CO=READIO(8,0) Read a return value and enter to the variable CO.
130 PRINT "CO=",CO Display C0 on the CRT.
140 END
```

OUTPCERR?

Outputs the ceramic resonator parameters; G_r , f_r , G_a , f_a , rpl_1 , rpl_2 , rpl_3 .

Syntax

OUTPCERR?

This command is query only.

Query Response

G_r , f_r , G_a , f_a , rpl_1 , rpl_2 , rpl_3

Where,

G_r	Gain at f_r
f_r	Resonant frequency
G_a	Gain at f_a
f_a	Anti-resonant frequency
rpl_1	Maximum ripple height in left side of resonant point
rpl_2	Maximum ripple height between resonant and anti-resonant point
rpl_3	Maximum ripple height in right side of anti-resonant point

Description

When OUTPCERR? is sent, instrument performs followings:

1. Searches for the minimum peak in the analysis range, then returns its gain G_r and frequency f_r .
2. Searches for the maximum peak in the analysis range, then returns its gain G_a and frequency f_a .
3. Sets the end point of the analysis range to f_r .
4. Searches the maximum height of the local maximum and the adjacent left-hand local minimum within range, then outputs as rpl_1 .
5. Sets the start of the analysis range to f_r , and the end of the analysis range to f_a .
6. Searches the maximum height of the local maximum and the maximum value of the adjacent right-hand local minimum which are between the resonant and anti resonant points, then outputs as rpl_2 .
7. Sets the start of the analysis range to f_a , and the end of the analysis range to the frequency that was initial setting.
8. Searches the maximum value of difference between the local maximum and the maximum value of the adjacent left-hand local minimum which are at the right of the resonant point, then outputs as rpl_3 .

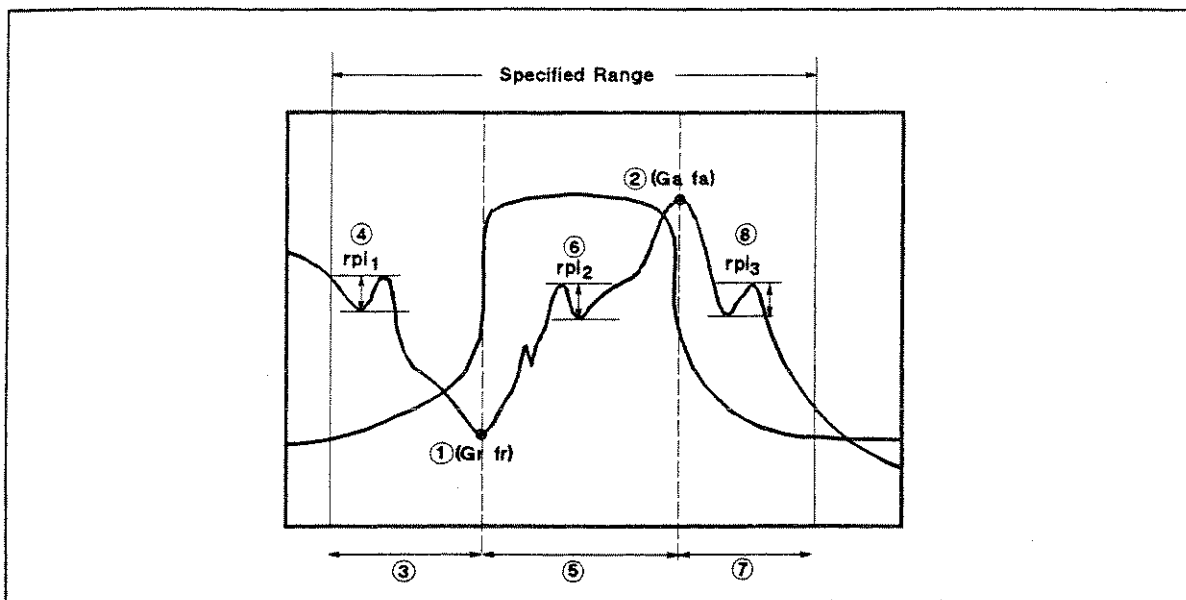

Figure 4-2. OUTPCERR?

Notes

This command is only available when the following formats are selected;

- LOG MAG & Phase
- LOG MAG & Delay
- LOG MAG

If another format is selected, the query returns 0.

If Z-conversion is selected, then the Z_r instead of the G_r and the Z_a instead of the G_a are returned.

Where,

Z_r Impedance at f_r

Z_a Impedance at f_a

If OUTPCERR? could not find any ripples, the query returns 0.

This command can be invoked with the EXECUTE command of Instrument BASIC.

Example

For the external controller:

```

100 OUTPUT 717;"OUTPCERR?"           Query the ceramic resonator parameters.
110 ENTER 717;Gr,Fr,Ga,Fa,Rpl1,Rpl2,Rpl3  Receive the all return value.
120 PRINT Gr,Fr,Ga,Fa,Rpl1,Rpl2,Rpl3     Display the result.
130 END

```

For Instrument BASIC:

```

100 EXECUTE "OUTPCERR?"              Invoke the OUTPCERR? query.
110 PRINT "Gr=",READIO(8,0)          Display the part of return value.
120 END

```



DECLARATION OF CONFORMITY

according to ISO/IEC Guide 22 and EN 45014

Manufacturer's Name: Yokogawa-Hewlett-Packard, LTD.

Manufacturer's Address: 9-1, Takakura-cho, Hachioji-shi, Tokyo, 192 Japan

declares, that the product

Product Name : Gain Phase Analyzer

Model Number(s) : HP 87510A

Product Options : This declaration covers all options of the above product.

conforms to the following Product Specifications :

Safety : HD-401 / IEC 348

EMC : EN 55011 (1991) / CISPR-11 Group 1, Class A
EN 50082-1 (1991) / IEC 801-2 4 kV CD, 8 kV AD
EN 50082-1 (1991) / IEC 801-3 (DRAFT), 3 V/m
EN 50082-1 (1991) / IEC 801-4 1 kV

Supplementary Information :

The product was tested in a typical configuration with Yokogawa-Hewlett-Packard.

Tokyo, Japan
Location

February 1, 1992
Date

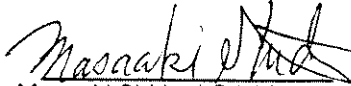
Masaaki Shida / QA Manager



Herstellerbescheinigung

Hiermit wird bescheinigt, daß das Gerät HP 87510A Gain-Phase Analyzer in Übereinstimmung mit den Bestimmungen von Postverfügung 1046/84 funkentstört ist.

Der Deutschen Bundespost wurde das Inverkehrbringen dieses Gerätes angezeigt und die Berechtigung zur Überprüfung der Serie auf Einhaltung der Bestimmungen eingeräumt.

Anm: Werden Meß- und Testgeräte mit ungeschirmten Kabeln und/oder in offenen Meßaufbauten verwendet, so ist vom Betreiber sicherzustellen, daß die Funk-Entstörbestimmungen unter Betriebsbedingungen an seiner Grundstücksgrenze eingehalten werden.

GERÄUSCHEMISSION

Lpa < 70 dB
am Arbeitsplatz
normaler Betrieb
nach DIN 45635 T. 19

Manufacturer's Declaration

This is to certify that this product, the HP 87510A Gain-Phase Analyzer, meets the radio frequency interference requirements of directive 1046/84. The German Bundespost has been notified that this equipment was put into circulation and was granted the right to check the product type for compliance with these requirements.

Note: If test and measurement equipment is operated with unshielded cables and/or used for measurements on open set-ups, the user must insure that under these operating conditions, the radio frequency interference limits are met at the border of his premises.

ACOUSTIC NOISE EMISSION

Lpa < 70 dB
operator position
normal operation
per ISO 7779

1

2

3

4

5

6

7

8

9

10

11

12

13

14

15

16

17

18

19

20

Documentation Map

Operation Manual Set (HP Part Number 87510-90000)

Reference Manual

The *Reference Manual* provides in-depth reference information, general information, and specifications.

HP-IB Programming Manual

The *HP-IB Programming Manual* provides a summary of all available HP-IB command, and shows how to make basic program to control the HP 87510A by a controller by HP-IB.

Using HP Instrument BASIC with the HP 87510A

The *Using HP Instrument BASIC with the HP 87510A* describes how HP Instrument BASIC works with the HP 87510A and any unique features.

Maintenance Manual (HP Part Number 87510-90030)

The *Maintenance Manual* explains how to verify conformance to published specifications.

Service Manual (Option 0B3), (HP Part Number 87510-90031)

The *Service Manual* explains how to adjust, troubleshoot, and repair the instrument.

HP Instrument BASIC HP Instrument BASIC Users Handbook (Option 002 only), (HP Part Number E2083-90000)

HP Instrument BASIC Programming Techniques

HP Instrument BASIC Interfacing Techniques

These two provide some helpful hints on getting the most use from HP Instrument BASIC programming language, and provide a general programming reference. This manual is furnished option 002.

HP Instrument BASIC Language Reference

The HP Instrument BASIC Language Reference provides a summary of all available HP Instrument BASIC Language. This manual is furnished option 002.



HP 87510A GAIN-PHASE ANALYZER OPERATION MANUAL

SERIAL NUMBERS

This manual applies directly to instruments with serial number prefix 3125J.
For additional important information about serial numbers, read "Instruments
Covered by This Manual" in Chapter 2 of the Reference Manual.



HP Part No. 87510-90000
Microfiche Part No. 87510-90050
Printed in JAPAN December 1991

Notice

The information contained in this document is subject to change without notice.

This document contains proprietary information which is protected by copyright. All rights are reserved. No part of this document may be photocopied, reproduced, or translated to another language without the prior written consent of the Hewlett-Packard Company.

Yokogawa-Hewlett-Packard, LTD.
Kobe Instrument Division
9-1, Takakura-cho, Hachioji-shi,
Tokyo, 192 Japan

Manual Printing History

The manual printing date and part number indicate its current edition. The printing date changes when a new edition is printed. (Minor corrections and updates which are incorporated at reprint do not cause the date to change.) The manual part number changes when extensive technical changes are incorporated.

December 1991..... 1st. Edition

Safety Summary

The following general safety precautions must be observed during all phases of operation, service, and repair of this instrument. Failure to comply with these precautions or with specific **WARNINGS** given elsewhere in this manual violates safety standards of design, manufacture, and intended use of the instrument.

The Hewlett-Packard Company assumes no liability for the customer's failure to comply with these requirements.

Ground The Instrument

This is a Safety Class 1 product (provided with a protective earthing terminal). An uninterruptible safety earth ground must be provided from the main power source to the product input wiring terminals, power source to the product input wiring terminals, power cord, or supplied power cord set. Whenever it is likely that the protection has been impaired, the product must be made inoperative and secured against any unintended operation.

DO NOT Operate In An Explosive Atmosphere

Do not operate the instrument in the presence of flammable gasses or fumes. Operation of any electrical instrument in such an environment constitutes a safety hazard.

Keep Away From Live Circuits

Operating personnel must not remove instrument covers. Component replacement and internal adjustments must be made by qualified maintenance personnel. Do not replace components with the power cable connected. Under certain conditions, dangerous voltages may exist even with the power cable removed. To avoid injuries, always disconnect power and discharge circuits before touching them.

DO NOT Service Or Adjust Alone

Do not attempt internal service or adjustment unless another person, capable of rendering first aid and resuscitation, is present.

DO NOT Substitute Parts Or Modify Instrument

Because of the danger of introducing additional hazards, do not substitute parts or perform unauthorized modifications to the instrument. Return the instrument to a Hewlett-Packard Sales and Service Office for service and repair to ensure the safety features are maintained.

Dangerous Procedure Warnings

Warnings, such as the example below, precede potentially dangerous procedures throughout this manual. Instructions contained in the warnings must be followed.

Warning



Dangerous voltages, capable of causing death, are present in this instrument. Use extreme caution when handling, testing, and adjusting this instrument.

How To Use This Manual

This is the Operating Manual for the HP 87510A Gain-Phase Analyzer. This manual contains specifications, installation, configuration, and operation in the procedure following documentations. After you receive your HP 87510A, begin with chapter 1. of Users Guide.

For error messages of the HP 87510A, refer to Error Message in the Operation Manual.

Typeface Conventions

Bold Boldface type is used when a term is defined. For example: **icons** are symbols.

Italics Italic type is used for emphasis and for titles of manuals and other publications.

Italic type is also used for keyboard entries when a name or a variable must be typed in place of the words in italics. For example: copy *filename* means to type the word *copy*, to type a space, and then to type the name of a file such as *file1*.

Computer Computer font is used for on-screen prompts and messages.

HARDKEYS Labeled keys on the instrument front panel are enclosed in □.

SOFTKEYS Softkeys located to the right of the CRT are enclosed in ▢.

Certification

Hewlett-Packard Company certifies that this product met its published specifications at the time of shipment from the factory. Hewlett-Packard further certifies that its calibration measurements are traceable to the United States National Institute of Standards and Technology, to the extent allowed by the Institution's calibration facility, or to the calibration facilities of other International Standards Organization members.

Warranty

This Hewlett-Packard instrument product is warranted against defects in material and workmanship for a period of one year from the date of shipment, except that in the case of certain components listed in *General Information* of this manual, the warranty shall be for the specified period. During the warranty period, Hewlett-Packard Company will, at its option, either repair or replace products which prove to be defective.

For warranty service or repair, this product must be returned to a service facility designated by HP. Buyer shall prepay shipping charges to HP and HP shall pay shipping charges to return the product to Buyer. However, Buyer shall pay all shipping charges, duties, and taxes for products returned to HP from another country.

HP warrants that its software and firmware designated by HP for use with an instrument will execute its programming instruction when properly installed on that instrument. HP does not warrant that the operation of the instrument, or software, or firmware will be uninterrupted or error free.

Limitation Of Warranty

The foregoing warranty shall not apply to defects resulting from improper or inadequate maintenance by Buyer, Buyer-supplied software or interfacing, unauthorized modification or misuse, operation outside of the environmental specifications for the product, or improper site preparation or maintenance.

No other warranty is expressed or implied. HP specifically disclaims the implied warranties of merchantability and fitness for a particular purpose.

Exclusive Remedies

The remedies provided herein are buyer's sole and exclusive remedies. HP shall not be liable for any direct, indirect, special, incidental, or consequential damages, whether based on contract, tort, or any other legal theory.

Assistance

Product maintenance agreements and other customer assistance agreements are available for Hewlett-Packard products.

For any assistance, contact your nearest Hewlett-Packard Sales and Service Office. Address are provided at the back of this manual.

Safety Symbols

General definitions of safety symbols used on equipment or in manuals.



Instruction manual symbol: the product will be marked with this symbol when it is necessary for the user to refer to the instruction manual in order to protect against damage to the instrument.



Indicates dangerous voltage (terminals fed from the interior by voltage exceeding 1000 volts must be so marked).

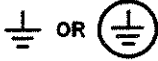

Protective conductor terminal. For protection against electrical shock in case of a fault. Used with wiring terminals to indicate the terminal which must be connected to ground before operating equipment.



Low-noise or noiseless, clean ground (earth) terminal. Used for a signal common, as well as providing protection against electrical shock in case of fault. A terminal marked with this symbol must be connected to ground in the manner described in the installation (Operation) manual, and before operating the equipment.

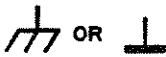

Frame or chassis terminal. A connection to the frame (chassis) of the equipment which normally includes all exposed metal structures.



Alternating current (power line).



Direct current (power line).



Alternating or direct current (power line).

Warning



Warning denotes a hazard. It calls attention to a procedure, practice, condition or the like, which, if not correctly performed or adhered to, could result in injury or death to personnel.

Caution



Caution sign denotes a hazard. It calls attention to a procedure, practice, condition or the like, which, if not correctly performed or adhered to, could result damage to or destruction of part or all of the product.

Note



Note denotes important information. It calls attention to a procedure, practice, condition or the like, which is essential to highlight.



**HP 87510A GAIN-PHASE ANALYZER
REFERENCE MANUAL**



Printed in JAPAN December 1991

GUIDE TO THE CHAPTERS IN THIS DOCUMENT

For information on specific topics, refer to the index at the end of this volume.

This section of this document is a complete reference for operation of the HP 87510A Gain-Phase Analyzer using either front panel controls, or an external controller. It is divided into chapters providing the following information:

- Chapter 1 provides getting started guide. Read this chapter first, when you get the HP 87510A.
- Chapter 2 provides the general information, which includes the product description, option and accessories available.
- Chapter 3 provides the specifications and typical characteristics of the HP 87510A.
- Chapter 4 includes a block diagram and functional description of the analyzer system. This is followed by descriptions of the front panel features and display labels, and the rear panel features and connectors.
- Chapters 5 through 14 provide detailed information on front panel keys and softkeys, their purpose and use, HP-IB equivalents in parentheses, and expected indications and results. Specific areas of operation described in these chapters include calibration procedures for accuracy enhancement, using markers, limit testing, plotting and printing, and saving instrument states.
- Chapter 15 contains information for operating the system remotely with a controller through HP-IB.
- Appendix provides a complete listing of the instrument preset state, a map of the operating softkey menu structure, information on I/O ports, and information on manual changes.
- Error Messages lists analyzer error messages, with explanations.
- Index lists an alphabetical index.

Safety Symbols

General definitions of safety symbols used on equipment or in manuals.



Instruction manual symbol: the product will be marked with this symbol when it is necessary for the user to refer to the instruction manual in order to protect against damage to the instrument.



Indicates dangerous voltage (terminals fed from the interior by voltage exceeding 1000 volts must be so marked).

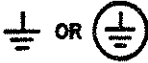

Protective conductor terminal. For protection against electrical shock in case of a fault. Used with wiring terminals to indicate the terminal which must be connected to ground before operating equipment.



Low-noise or noiseless, clean ground (earth) terminal. Used for a signal common, as well as providing protection against electrical shock in case of fault. A terminal marked with this symbol must be connected to ground before operating the equipment.

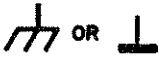

Frame or chassis terminal. A connection to the frame (chassis) of the equipment which normally includes all exposed metal structures.



Alternating current (power line).



Direct current (power line).



Alternating or direct current (power line).

Warning



Warning denotes a hazard. It calls attention to a procedure, practice, condition or the like, which, if not correctly performed or adhered to, could result in injury or death to personnel.

Caution



Caution sign denotes a hazard. It calls attention to a procedure, practice, condition or the like, which, if not correctly performed or adhered to, could result in damage to or destruction of part or all of the product.

Note



Note denotes important information. It calls attention to a procedure, practice, condition or the like, which is essential to highlight.

Contents

1. Getting Started	
Introduction	1-1
Unpacking Your Instrument	1-1
Operating Conditions	1-2
Power Considerations	1-3
Instrument Setup	1-4
Turning on the Analyzer	1-4
HARDKEYS and SOFTKEYS	1-4
Checking HP-IB Addresses	1-5
2. General Information	
About this Manual Set	2-1
Instruments Covered by This Manual	2-1
Microfiche Copies of the Manual	2-1
HP 87510A Description	2-2
Additional Features	2-2
Advanced List Sweep Mode	2-2
Automatic Sweep Time	2-2
Automatic Interpolated Error Correction	2-2
Four Trace Simultaneous Measurement	2-2
HP Instrument BASIC	2-3
I/O port	2-3
Waveform Analysis Commands	2-3
Hewlett-Packard Interface Bus (HP-IB)	2-3
Options Available	2-4
Option 001, High Stability Frequency Reference	2-4
Option 002, Keyboard for HP Instrument BASIC	2-4
Option 003, Type-N Input Connector	2-4
Option 004, Delete Reference Channel	2-4
Option 005, Parallel I/O Mode A	2-4
Option 006, Parallel I/O Mode B	2-4
Option 0B0, Delete Operation Manual	2-4
Option 907, Front Handle Kit	2-4
Option 908, Rack Mount Kit	2-4
Option 909, Rack and Handle Kit	2-5
Option 0B1, Extra Operation Manual	2-5
Option 0B3, Add Service Manual	2-5
Measurement Accessories Available	2-5
Active Probes	2-5
HP 41800A Active Probe	2-5
HP 41802A 1 M Ω Input Adapter	2-5
System Accessories Available	2-5
System Rack	2-5
Plotters and Printers	2-6
HP-IB Cables	2-6

Disks and Disk Accessories	2-6
3. Instrument Specifications	
Source	3-1
Frequency Characteristics	3-1
Output Power Characteristics	3-1
Power Splitter	3-1
Spectral Purity Characteristics	3-2
Other Source Information	3-2
Receiver	3-2
Input Characteristics	3-2
Magnitude Characteristics	3-2
Absolute Characteristics	3-2
Ratio Characteristics	3-3
Phase Characteristics	3-3
Delay Characteristics	3-4
General Characteristics	3-4
Rear Panel Specifications	3-5
I/O Buses	3-5
HP-IB Interface	3-5
I/O Port	3-5
BNC Connectors	3-5
"EXT REF INPUT 10/N MHz" Connector	3-5
"REF OVEN (OPTION 001)" Connector	3-5
"INT REF OUTPUT" Connector	3-5
"EXT TRIGGER" Connector	3-6
"EXT PROG RUN/CONT" Connector	3-6
Specifications when Option Is Installed	3-6
Specifications When Option 003 Type N Connector Is Installed	3-6
Specifications When Option 004 Delete Rch Is Installed	3-6
Furnished Accessories	3-7
4. System Overview	
System Overview	4-1
Overall Operation	4-1
The Built-In Synthesized Source	4-1
The Built-in Power Splitter	4-2
The Receiver Block	4-2
The Microprocessors	4-2
Data Processing	4-2
Overview	4-2
Important Concepts	4-2
Processing Details	4-3
The ADCs	4-3
Digital Filter	4-3
IF Correction	4-4
Ratio Calculations	4-4
Sweep-to-sweep Averaging	4-4
Vector Error Correction (Accuracy Enhancement)	4-4
The Delay Block (Electrical Delay)	4-4
Conversion Transforms	4-4
Formatting	4-4
Smoothing	4
Format Arrays	4-5
Scaling	4-5

Display Memory	4-5
5. Front and Rear Panel	
Introduction	5-1
Active Function	5-1
Front Panel Keys and Softkey Menus	5-1
Softkeys that are Joined by Vertical Lines	5-2
Softkeys That Toggle ON or OFF	5-2
Softkeys that Show Status Indications in Brackets	5-2
Function Key Blocks	5-2
Stimulus Block	5-2
Response Block	5-2
Instrument State Block	5-2
HP-IB Control	5-3
Information on Keys and Softkeys	5-3
Front Panel Features	5-3
CRT Display	5-5
Rear Panel Features and Connectors	5-8
6. Active Channel Block	
Active Channel Keys	6-1
7. Entry Block	
Entry Block Keys	7-1
8. Stimulus Function Block	
Introduction	8-1
START, STOP, CENTER, and SPAN Keys	8-1
MENU Key	8-2
Stimulus Menu	8-3
Sweep Time Menu	8-5
Trigger Menu	8-6
Sweep Type Menu	8-7
List Sweep Menu	8-8
Edit List Menu	8-9
Edit Segment Menu	8-10
Edit Segment More Menu	8-11
Clear List Menu	8-12
9. Response Function Block	
Introduction	9-1
MEAS Key	9-2
Input Ports Menu	9-2
Conversion Menu	9-3
FORMAT Key	9-5
Format Menu	9-5
Format More Menu	9-8
Group Delay Principles	9-9
SCALE REF Key	9-11
Scale Reference Menu	9-11
Electrical Delay Menu	9-13
DISPLAY Key	9-14
Display Menu	9-14
Display More Menu	9-16
Display Allocation Menu	9-17

Title Menu	9-18
(AVG) Key	9-19
Averaging	9-19
Smoothing	9-20
IF Bandwidth Reduction	9-20
Group Delay Aperture	9-21
Average Menu	9-21
IF Bandwidth Menu	9-23
(SPCL FCTN) Key	9-24
Special Function Menu	9-24
Special Function More Menu	9-26
10. Measurement Calibration	
Introduction	10-1
Accuracy Enhancement	10-1
Correcting for Measurement Errors	10-2
Menus and Softkeys	10-3
(CAL) Key	10-3
Interpolated Error Correction	10-3
Channel Coupling	10-4
Omitting Isolation Calibration	10-4
Stopping During the Calibration Procedure	10-4
Saving Calibration Data	10-4
Specifying Calibration Kits	10-4
Correction Menu	10-5
Select Cal Kit Menu	10-6
Calibrate More Menu	10-7
Reference Plane Menu	10-8
Calibration Menu	10-9
Response Calibration for Transmission Measurements	10-10
Response and Isolation Calibration for Transmission Measurements	10-10
Modifying Calibration Kits	10-11
Definitions	10-12
Procedure	10-12
Modify Cal Kit Menu	10-13
Define Standard Number Menu	10-15
Define Standard Menus	10-15
Specify Offset Menu	10-17
Label Standard Menu	10-18
Specify Class Menus	10-18
Label Class Menus	10-19
Label Kit Menu	10-19
Verify Performance	10-20
11. Using Markers	
(MKR) Key	11-1
Marker Menu	11-3
Activate marker menu	11-4
Clear Marker Menu	11-5
Delta Marker Mode Menu	11-5
Delta Marker Menu	11-6
Fixed Marker Menu	11-7
Marker Mode Menu	11-9
Polar Marker Menu	11-10
(MKR FCTN) Key	11-11

Marker Function Menu	11-11
Search Range Menu	11-13
Marker Search Menu	11-14
Target Menu	11-15
Marker Search More Menu	11-16
Note For Peak Define	11-16
Width Menu	11-17
12. Instrument State Function Block	
Introduction	12-1
Instrument State Functions and Where They Are Described	12-1
LOCAL Key	12-2
Local Lockout	12-3
HP-IB Menu	12-3
System Controller Mode	12-3
Addressable Mode	12-3
Address Menu	12-4
SYSTEM Key	12-6
System Menu	12-6
Instrument BASIC	12-7
BASIC Menu	12-7
Edit System Menu	12-8
ON KEY LABEL Menu	12-8
File Utility Menu	12-8
Command Entry Menu	12-9
Real Time Clock	12-9
Clock Menu	12-10
Set Time Menu	12-10
Set Date Menu	12-10
BIN Sort Function	12-11
Example of Using the BIN Sort Function	12-11
BIN Sort Softkey Menu	12-13
BIN Sort Menu	12-13
Edit BIN Sort Menu	12-14
Edit BIN Sort Table Menu	12-15
Clear Menu	12-16
Limit Line and Limit Testing	12-16
How Limit Lines are Entered	12-18
Turning Limit Lines Limit Testing On and Off	12-19
Segments Entering Order Needs Notice	12-19
Saving the Limit Line Table	12-19
Offsetting the Stimulus or Amplitude of the Limit Lines	12-19
Supported Display Formats	12-19
Use a Sufficient Number of Points or Errors May Occur	12-19
Displaying, Printing, or Plotting Limit Test Data	12-20
Results of Plotting or Printing the Display with Limit Lines ON	12-20
Limit Menu	12-20
Edit Limits Menu	12-21
Edit Segment Menu	12-22
Clear List Menu	12-24
Offset Limit Menu	12-24
Using Limit Line Testing	12-25
Example of Limit Lines for Filter Testing	12-25
Instrument Setting	12-25
Creating Limit Lines	12-26

Modifying Limit Lines Using The Rotary Knob and Marker	12-27
Performing Limit Test	12-27
Example 2. Separated Limit Lines	12-28
13. Making Hard Copies	
Introduction	13-1
About Making Hard Copies, Where Compatible Printers and Plotters are Mentioned	13-1
Where to Find Tutorial Information	13-1
Printing/Plotting with or without a Controller on the Bus	13-1
Print/Plot Buffer	13-2
COPY Key	13-2
Copy Menu	13-4
Select Quadrant Menu	13-5
Define Plot Menu	13-6
Pen Numbers	13-6
Scale Plot Menu	13-7
Copy More Menu	13-8
Copy Cal Kit Menu	13-10
Copy Standard Number Menu	13-11
Copy List Sweep Menu	13-11
Copy Limit Test Menu	13-12
Screen Menu	13-13
Using Printer and Plotter	13-14
Preparing Printers/Plotters	13-14
Available Displays To Print/Plot	13-14
Output with The Time/Date	13-14
Adding a Title	13-14
Printing Procedure	13-14
Plotting Procedure	13-15
Printing and Plotting Troubleshooting	13-15
14. Saving and Recalling Instrument States and Data	
Introduction	14-1
Storage Devices	14-1
File Types and Data Saved	14-2
Binary Files and ASCII Files	14-2
Data Groups	14-2
Instrument States	14-2
Internal Data Arrays	14-2
Instrument States and Internal Data Arrays	14-3
Internal Data Arrays (ASCII file)	14-3
Graphics	14-3
Additional Information	14-3
RAM Disk Memory Capacity	14-3
Operating Time of the Battery Backup for RAM Disk Memory	14-3
Disk Requirements	14-4
Disk Formats	14-4
File Names	14-4
Copy Files Between the RAM Disk and the Flexible Disk	14-5
Auto Recall Function	14-5
File Size	14-5
File Structure of Internal Data Arrays File for Binary Files	14-6
File Header	14-6
Data Group	14-6

Data Segment	14-7
File Structure of Internal Data Arrays File for ASCII File	14-8
Status Block and Data Block	14-8
File Structure for Single Channel and Dual Channel	14-10
Data Array Names	14-10
Data Groups	14-11
SAVE and RECALL Keys	14-11
Save Menu	14-13
Title Menu	14-14
ASCII Save Menu	14-15
Define Extension Menu	14-16
Define Save Data Menu	14-17
Re-save File Menu	14-18
Disk Menu	14-19
Purge File Menu	14-20
Purge Menu	14-21
Initialize Menu	14-21
Recall File Menu	14-22
Copy Menu	14-23
Destination Menu	14-24
15. HP-IB Remote Programming	
Introduction	15-1
How HP-IB Works	15-1
Talker	15-2
Listener	15-2
Controller	15-2
HP-IB Requirements	15-2
Analyzer HP-IB Capabilities	15-3
Bus Mode	15-3
Setting Addresses	15-4
A. Manual Changes	
Introduction	A-1
Manual Changes	A-1
B. Default	
Preset State	B-1
Predefined Calibration Kit	B-6
Predefined Standards	B-6
Predefined Standard Class Assignments	B-8
C. Parallel I/O (STANDARD and OPTION 006)	
I/O Ports	C-1
Control Signal Lines	C-2
Port C Status Output Signal or Port D Status Output Signal	C-2
WRITE STROBE Output Signal for Output Port	C-2
INPUT1 Input Signal	C-2
OUTPUT1 Output Signal or OUTPUT2 Output Signal	C-3
PASS/FAIL Output Signal	C-3
WRITE STROBE Output Signal for PASS/FAIL Output	C-3
SWEEP END Output Signal	C-3
Pin Assignment	C-4
HP-IB Commands for Parallel I/O Port Control	C-7
Data Output Commands	C-7

Data Input Commands	C-7
Commands for Setting Input/Output Directions of Ports C and D	C-7
Positive and Negative Logic Setting Commands	C-7
OUTPUT1 and OUTPUT2 Level Setting Commands	C-8
Commands for Setting OUTPUT1 and OUTPUT2 at the High or Low Level upon input of a Pulse to INPUT1	C-8
Command for Checking Input to INPUT1	C-8
D. Option 005 Parallel I/O Mode A (8-bit)	
I/O Port	D-1
Pin Assignment	D-1
Related HP-IB Commands	D-2
E. Softkey Tree	
STIMULUS Block	E-1
RESPONSE Block	E-2
INSTRUMENT STATE FUNCTION Block	E-8
Messages	
Error Messages in Alphabetical Order	Messages-1
Error Messages in Numerical Order	Messages-12
Index	

Figures

1-1. HP 87510A and Furnished Accessories	1-2
1-2. Voltage Selector	1-3
1-3. Connecting BNC adapter (Option 001 Only)	1-4
2-1. Typical Serial Number Plate	2-1
3-1. Trigger Signal	3-6
3-2. Power Cables Supplied	3-8
4-1. Simplified Block Diagram of the Network Analyzer System	4-1
4-2. Data Processing Flow Diagram	4-3
5-1. HP 87510A Front Panel	5-3
5-2. CRT Display (Single Channel, Cartesian Format)	5-5
5-3. HP 87510A Rear Panel	5-8
6-1. Active Channel Keys	6-1
7-1. Entry Block	7-1
8-1. Stimulus Function Block	8-1
8-2. Softkey Menus Accessed from the MENU Key	8-2
8-3. Stimulus Menu	8-3
8-4. Sweep Time Menu	8-5
8-5. Trigger Menu	8-6
8-6. Sweep Type Menu	8-7
8-7. List Sweep Menu	8-8
8-8. Edit List Menu	8-9
8-9. Edit Segment Menu	8-10
8-10. Edit Segment More Menu	8-11
8-11. Clear List Menu	8-12
9-1. Response Function Block	9-1
9-2. Softkey Menus Accessed from the MEAS Key	9-2
9-3. Input Ports Menu	9-3
9-4. Transmission Impedance and Admittance Conversions	9-3
9-5. Conversion Menu	9-4
9-6. Format and Format More Menus	9-5
9-7. Log Magnitude Format	9-5
9-8. Phase Format	9-6
9-9. Group Delay Format	9-6
9-10. Linear Magnitude Format	9-7
9-11. Expanded phase Format	9-7
9-12. Log Magnitude and Phase Format	9-7
9-13. Log magnitude and Delay Format	9-8
9-14. Real Format	9-8
9-15. Polar Format	9-9
9-16. Constant Group Delay	9-9
9-17. Higher Order Phase Shift	9-10
9-18. Rate of Phase Change Versus Frequency	9-10
9-19. Variations in Frequency Aperture	9-10
9-20. Softkey Menus Accessed from the SCALE REF Key	9-11
9-21. Scale Reference Menu	9-12
9-22. Electrical Delay Menu	9-13

9-23. Softkey Menus Accessed from the DISPLAY Key	9-14
9-24. Display Menu	9-14
9-25. Full-screen and Split Display	9-15
9-26. Display More Menu	9-16
9-27. Display Allocation Menu	9-17
9-28. Title Menu	9-18
9-29. Softkey Menus Accessed from the AVG Key	9-19
9-30. Effect of Averaging on a Trace	9-19
9-31. Effect of Smoothing on a Trace	9-20
9-32. IF Bandwidth Reduction	9-21
9-33. Average Menu	9-21
9-34. IF Bandwidth Menu	9-23
9-35. Softkey Menus Accessed from the SPCL FCTN Key	9-24
9-36. Special Function Menu	9-24
9-37. Output Filter Parameters Example	9-25
9-38. Four-Element Equivalent Circuit for Crystal Resonator	9-26
9-39. Special Function More Menu	9-26
10-1. Softkey Menus Accessed from the CAL Key	10-3
10-2. Correction Menu	10-5
10-3. Select Cal Kit Menu	10-6
10-4. Calibrate More Menu	10-7
10-5. Reference Plane Menu	10-8
10-6. Calibration Menu	10-9
10-7. Response Cal Menu	10-10
10-8. Modify Cal Kit Menus	10-13
10-9. Modify Cal Kit Menu	10-14
10-10. Define Standard Number Menu	10-15
10-11. Specify Offset Menu	10-17
11-1. Menus Accessed from the MKR Key	11-2
11-2. Marker Menu	11-3
11-3. Activate Marker Menu	11-4
11-4. Clear Marker Menu	11-5
11-5. Delta Marker Mode Menu	11-6
11-6. Delta Marker Menu	11-7
11-7. Fixed Marker Menu	11-8
11-8. Marker Mode Menu	11-9
11-9. Polar Marker Menu	11-10
11-10. Menus Accessed from the MKR FCTN Key	11-11
11-11. Marker Function Menu	11-12
11-12. Search Range Menu	11-13
11-13. Marker Search Menu	11-14
11-14. Target Menu	11-15
11-15. Marker Search More Menu	11-16
11-16. Peak Definition Example	11-17
11-17. Width Menu	11-17
11-18. Bandwidth Search Example	11-18
12-1. Instrument State Function Block	12-1
12-2. Softkey Menus Accessed from the LOCAL Key	12-2
12-3. HP-IB Menu	12-3
12-4. Address Menu	12-5
12-5. System Menu	12-6
12-6. Softkey Menus Accessed from the IBASIC Softkey	12-7
12-7. Softkey Menus Accessed from the SET CLOCK Softkey	12-9
12-8. Example of Sorting by Deviation	12-12

12-9. A Complex Example	12-12
12-10. Softkey Menu Accessed from the BIN SORT MENU Softkey	12-13
12-11. BIN Sort Menu	12-13
12-12. Edit BIN Sort Menu	12-14
12-13. Edit BIN Sort Table Menu	12-15
12-14. Clear Menu	12-16
12-15. Softkey Menus Access from the LIMIT MENU softkey.	12-17
12-16. The Concept of Segments as a Point between Two Sets of Limit Lines	12-18
12-17. Limits Menu	12-20
12-18. Edit Limits Menu	12-22
12-19. Edit Segment Menu	12-23
12-20. Clear List Menu	12-24
12-21. Offset Limit Menu	12-24
12-22. Limit Line Example	12-25
12-23. Editing the Limit Lines	12-27
12-24. Limit Lines Example 2 (Separated Limit Lines)	12-28
13-1. Softkey Menus Accessed from the COPY Key	13-3
13-2. Copy Menu	13-4
13-3. Select Quadrant Menu	13-5
13-4. Define Plot Menu	13-6
13-5. Scale Plot Menu	13-7
13-6. Full, Upper, and Lower Graticule	13-8
13-7. Copy More Menu	13-8
13-8. Copy Cal Kit Menu	13-10
13-9. Copy Standard Number Menu	13-11
13-10. Copy List Sweep Menu	13-11
13-11. Copy Limit Test Menu	13-12
13-12. Screen Menu	13-13
14-1. File Header Structure	14-6
14-2. CAL Data Group Structure	14-7
14-3. Data Segment	14-7
14-4. Softkey Menus Accessed from the SAVE and RECALL Keys	14-12
14-5. Save Menu	14-13
14-6. Title Menu	14-14
14-7. ASCII Save Menu	14-15
14-8. Define Extension Menu	14-16
14-9. Define Save Data Menu	14-17
14-10. Re-save File Menu	14-18
14-11. Disk Menu	14-19
14-12. Purge File Menu	14-20
14-13. Purge Menu	14-21
14-14. Initialize Menu	14-21
14-15. Recall File Menu	14-22
14-16. Copy Menu	14-23
14-17. Destination Menu	14-24
15-1. Analyzer Single Bus Concept	15-3
C-1. Write strobe signal timing chart	C-2
C-2. Schematic Drawing of Parallel I/O Ports	C-4
C-3. Parallel I/O Port Connector Pin Numbers	C-4
D-1. 8-bit I/O Port Pin Assignments	D-1
E-1. MENU key	E-1
E-2. MEAS Key	E-2
E-3. FORMAT Key	E-2
E-4. SCALE REF Key	E-3
E-5. DISPLAY Key	E-3

E-6.	AVG Key	E-3
E-7.	CAL Key (1/2)	E-4
E-8.	CAL Key (2/2)	E-5
E-9.	MKR Key	E-6
E-10.	MKR FCTN Key	E-7
E-11.	SPCL FCTN Key	E-7
E-12.	LOCAL Key	E-8
E-13.	SYSTEM Key (1/4)	E-8
E-14.	SYSTEM Key (2/4)	E-9
E-15.	SYSTEM Key (3/4)	E-9
E-16.	SYSTEM Key (4/4)	E-10
E-17.	COPY Key	E-11
E-18.	SAVE and RECALL Key	E-12

Tables

1-1. AC Line Voltage	1-3
1-2. Factory-set Addresses	1-5
2-1. Disks and Disk Accessories	2-6
8-1. Minimum Sweep Time In Seconds (Typical Value)	8-6
9-1. IF Bandwidth in AUTO mode	9-23
10-1. Differences between <u>PORT EXTENSIONS</u> and <u>ELECTRICAL DELAY</u>	10-7
10-2. Standard Definitions	10-16
10-3. Standard Class Assignments Table	10-18
12-1. Instrument State Function Descriptions	12-2
12-2. Default HP-IB Addresses	12-4
13-1. Default Plotting Parameters	13-5
13-2. Pen Numbers	13-6
13-3. List Value Format	13-9
14-1. Valid Characters for File Names	14-4
14-2. Suffixes and Extensions Added Automatically	14-4
14-3. File Size Versus Number of Points (binary files)	14-5
14-4. File Size Versus Number of Points (ASCII files) 1/2	14-5
14-5. File Size Versus Number of Points (ASCII files) 2/2	14-6
14-6. Contents of ASCII Files	14-9
14-7. Data Groups and Data Array Names	14-10
14-8. Calibration Type Versus CAL Data Saved	14-11
A-1. Manual Changes by Serial Number	A-1
A-2. Manual Changes by Firmware Version	A-1
B-1. Preset Conditions	B-1
B-2. Preset conditions	B-2
B-3. Preset conditions	B-3
B-4. Preset conditions	B-4
B-5. Preset conditions	B-5
B-6. Preset Conditions	B-5
B-7. Results of Power Loss to Battery Backup Memory (Factory Setting)	B-6
B-8. 7 mm Standard Cal Kit	B-6
B-9. 50 Ω Type-N Standard Cal Kit	B-7
B-10. 75 Ω Type-N Standard Cal Kit	B-7
B-11. Standard Class Assignments Table (7 mm)	B-8
B-12. Standard Class Assignments Table (50 Ω Type-N)	B-8
B-13. Standard Class Assignments Table (75 Ω Type-N)	B-9
C-1. Assignment of Signals to Pins (Standard)	C-5
C-2. Assignment of Signals to Pins (Option 006)	C-6



Getting Started

Introduction

This chapter describes how to set up the HP 87510A. Read this chapter when you first get the HP 87510A. The main topics of this chapter are:

- Unpacking Your Instrument
- Operating Conditions
- Power Considerations
- Instrument Setup
- Turning on the Analyzer
- Checking the HP-IB Address

Unpacking Your Instrument

This instrument has been carefully inspected both electrically and mechanically before being shipped from the factory. It should be in perfect physical condition, no scratches, dents, or the like, and it should be in perfect electrical condition. Verify this by carefully performing an incoming inspection to check the instrument for signs of physical damage, missing contents, and to check that it passes the electrical performance test. If any discrepancy is found, notify the carrier and Hewlett-Packard. Your HP Sales Office will arrange for repair and replacement without waiting for the claim to be settled.

1. Inspect the shipping container for damage, and keep the shipping materials until the inspection is completed.
2. Verify that the shipping container contains everything shown in Figure 1-1.
3. Make sure the serial number on the analyzer's rear panel matches that on the shipping documents.
4. Inspect the exterior of the HP 87510A for any signs of damage.
5. Verify that the HP 87510A is equipped with the options you ordered.
6. To verify the HP 87510A's electrical performance, perform the Performance Test, described in the *HP 87510A Maintenance Manual* (HP part number 87510-90030).

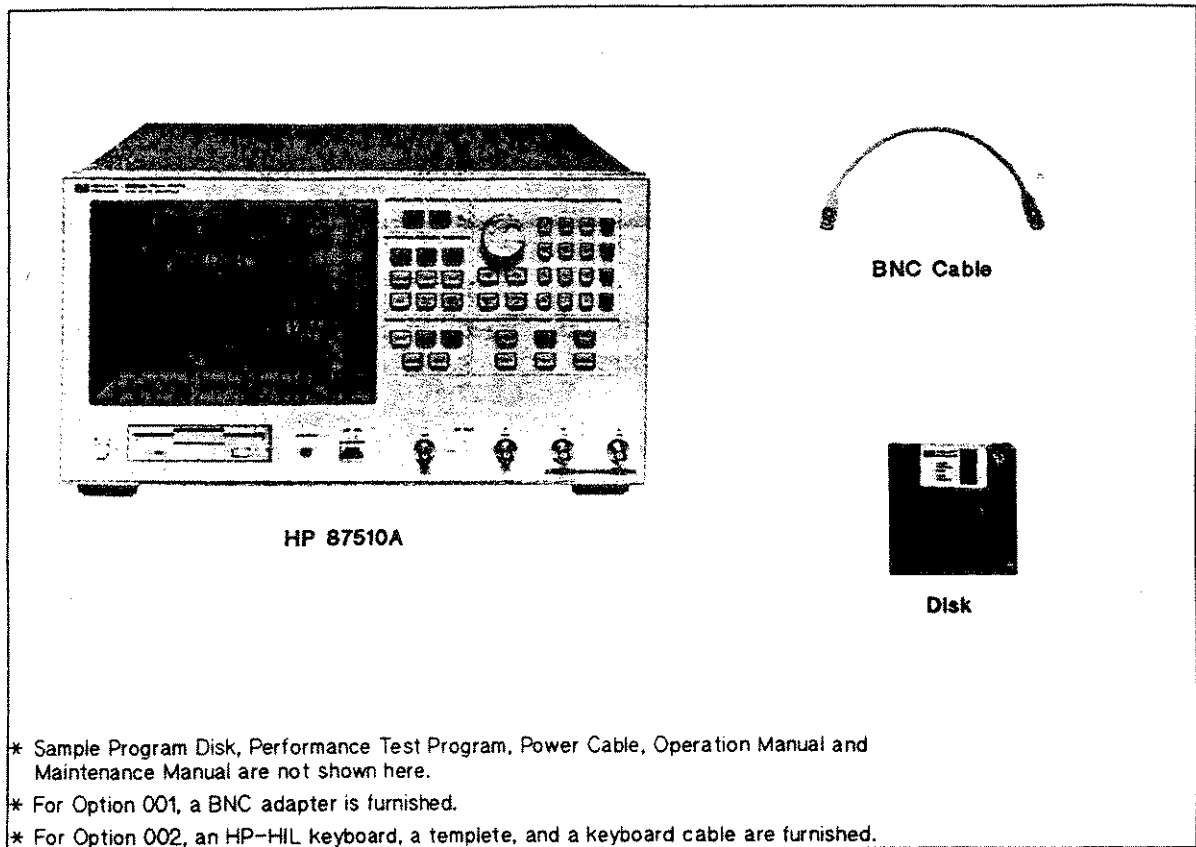

Figure 1-1. HP 87510A and Furnished Accessories

Caution



Electrostatic discharge (ESD) can damage the analyzer and other sensitive electronic devices. Use static-safe work stations and procedures.

Operating Conditions

The analyzer will operate within a wide range of temperatures, altitudes, and levels of humidity. The operating conditions are as follows:

- Temperature : 0 to 55 °C (When disk drive is not in operation)
- Humidity (at wet bulb ≤ 29 °C, without condensation) :
15% \leq RH \leq 95% (When disk drive is not in operation)
- Altitude : 0 to 4,500 meters (15,000 feet)

See Chapter 3 for more details. Note that enhanced accuracy performance and some instrument specifications require an environmental temperature of 23 ± 5 °C.

Power Considerations

Warning



This is a safety class 1 product (provided with a protective earth terminal). A noninterruptable safety earth ground must be provided from the main power source to the HP 87510A's power input terminals, power cord, or supplied power cord set. Whenever the safety earth ground has been impaired, the instrument must be made inoperative and secured against any unintended operation. If this instrument is to be energized via an autotransformer (Not Recommended) for voltage reduction, make sure that the common terminal is connected to the earth pole of the power source.

Confirm that the analyzer voltage selector (shown in Figure 1-2) is set to match the AC line voltage before plugging in the analyzer.

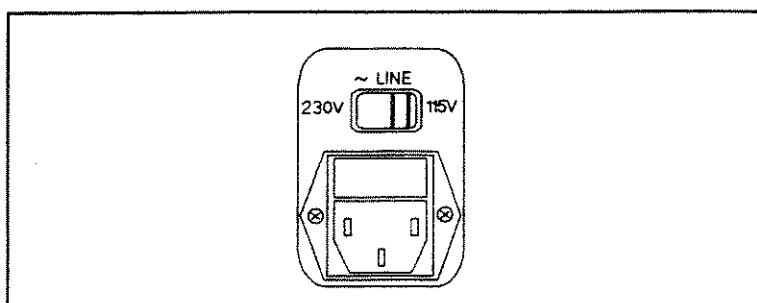

Figure 1-2. Voltage Selector

Table 1-1. AC Line Voltage

Nominal Setting	AC Line Power
115 V	90 V to 132 V (at 47 to 66 Hz)
230 V	198 V to 264 V (at 47 to 66 Hz)

For information on line fuse replacement, see Chapter 1 of the *Maintenance Manual*.

To protect operating personnel, the National Electrical Manufacturer's Association (NEMA) recommends that the instrument panel and cabinet be grounded. The HP 87510A is equipped with a three-conductor power cord that, when plugged into the appropriate AC power receptacle, grounds the instrument. The offset pin on the power cord is the safety ground.

To preserve the protection feature when operating the instrument from a two prong outlet, use a three-prong to two-prong adapter (HP Part Number 1251-8196) and connect the green pigtail on the adapter to the protective earth connection.

Caution



The power plug must be plugged into an outlet that provides a protective earth connection. DO NOT use an extension cord or power cord that does not have a protective ground.

Instrument Setup

This section describes HP 87510A system setups.

Note



For an HP 87510A with Option 001, connect the EXT REF INPUT connector to the REF OVEN connector on the rear panel using the furnished BNC adapter. (See Figure 1-3.)

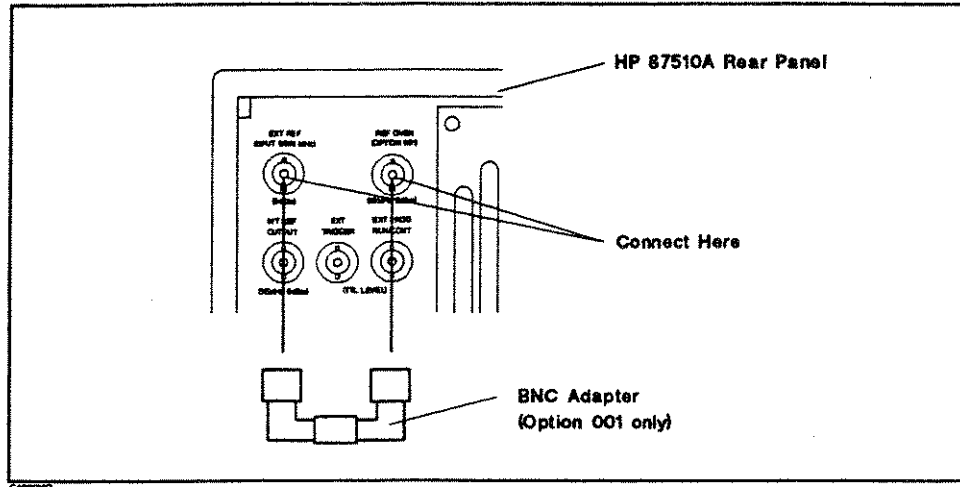

Figure 1-3. Connecting BNC adapter (Option 001 Only)

Turning on the Analyzer

Turn the line switch ON. The analyzer should power up with no error messages displayed, in which case, the analyzer has passed its internal diagnostic tests and is functioning properly.

Note



If an error message is displayed, or if the instrument does not appear to operate properly, see "Error Messages" in this manual.

HARDKEYS and **SOFTKEYS**

In this guide, front panel keys (hard keys) are represented by print surrounded by a box, **xxx**. Display softkeys are shown as print on a half-tone background, **xxx**.

For example: "Press **SCALE REF** **REFERENCE POSITION** -10 **x1**" means you should press the **SCALE REF** key, then the **REFERENCE POSITION** softkey, followed by the **-**, **1**, **0** and **x1** keys. The last key, **x1**, terminates the command in basic units (dB, dBm, Hz, or degrees). More explanation of display keys is found in after Chapter 5.

Checking HP-IB Addresses

For hard copy output, an HP-IB cable must connect the analyzer to an HP-IB equipped printer or plotter.

To communicate by HP-IB, two conditions must be satisfied:

- Each device must have a unique address.
- The analyzer must recognize each address.

To check each device's HP-IB address, see its manual (most addresses are set with switches). To check the analyzer's address, press **LOCAL** **SET ADDRESSES** **ADDRESS : 87510**. The analyzer's address will appear.

Table 1-2 shows the factory-set device addresses which are also the default addresses recognized by the analyzer.

Table 1-2. Factory-set Addresses

Device	HP-IB Address
HP 87510A	17
Printer	1
Plotter	5
External Controller (computer)	21

To change an HP-IB address (recognized by the analyzer) to match a device address, press the device softkey and then enter the address and **(x1)**.



General Information

About this Manual Set

This *HP 87510A Gain-Phase Analyzer Operation Manual* is a complete guide to operating the analyzer. It is part of a two manual set; the *Maintenance Manual* completes the set.

To explore the manuals further, inspect their title pages and the "Contents" and "Index" sections.

Instruments Covered by This Manual

The instrument you received with this manual is covered by this manual without change. Any other instrument with one of the serial number prefixes listed on the title page is also described by this manual. (The serial number plate, shown in Figure 2-1, is attached to the rear panel of the analyzer.)

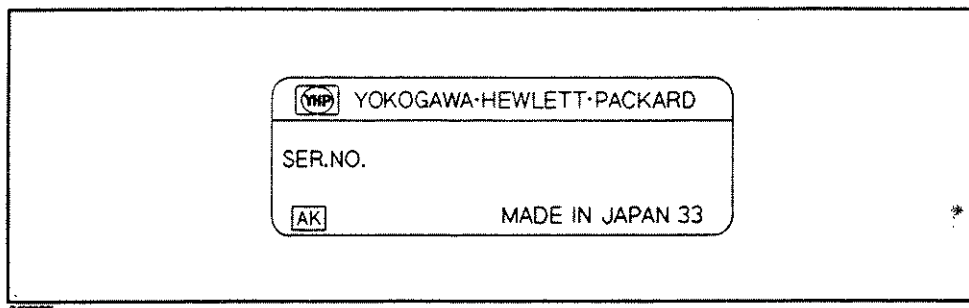

Figure 2-1. Typical Serial Number Plate

Other instruments differ from the instruments covered directly by this manual. Those differences are documented in the Appendix A section. See Appendix A section if the serial number prefix of your instrument is not listed on the title page.

Microfiche Copies of the Manual

Use the microfiche part number on the title page to order a package of 10 × 15 centimeter (4 × 6 inch) microfilm transparencies of this manual and the *Maintenance manual*.

HP 87510A Description

The HP 87510A is a 100 kHz to 300 MHz Gain-phase analyzer for measuring transmission parameters. It integrates a high resolution synthesized RF source, and a dual channel, two-input receiver to measure and display magnitude, phase, and group delay responses of active and passive RF networks. Option 001 provides a high stability frequency reference, and Option 002 provides HP Instrument BASIC programmability. For information on other options, see "Options Available" later in this section.

Two independent display channels and a large screen CRT display the measurement results of one or both channels, in rectangular or polar chart formats. The display function has the capability to display three traces simultaneously.

Digital signal processing and microprocessor control combine to provide easy operation and measurement improvement. Measurement functions are selected with front panel keys and softkey menus. Displayed measurement results can be printed or plotted directly with a compatible peripheral without the use of an external computer. A built-in micro flexible disk drive and RAM disk memory store and recall instrument states and trace data (measurement data).

Trace math, data averaging, trace smoothing, electrical delay, and accuracy enhancement provide performance improvement and flexibility. Accuracy enhancement methods range from normalizing data to 3 term vector error correction.

Additional Features

In addition to the above capabilities, this analyzer has several features:

Advanced List Sweep Mode

The analyzer can measure specifically at user defined frequencies, power levels, IF bandwidths, and number of points as defined in the List Segment. The list sweep mode can make the display resolution even, even though the frequency points are not evenly distributed, as well as making the frequency base display even.

Automatic Sweep Time

The analyzer can automatically shorten sweep time as much as possible for the given IF bandwidth, number of points, averaging mode, frequency range, and sweep type.

Automatic Interpolated Error Correction

This allows the operator to perform any type of calibration, and then display any subset of that frequency range or use a different number of points. If the operator changes the stimulus parameter, the analyzer turns the interpolated error correction ON, and new error coefficients are interpolated from the coefficients of the original calibration. Interpolated error correction provides a great improvement over uncorrected measurements, but the accuracy of interpolated error corrected points is not specified. See Chapter 10.

Four Trace Simultaneous Measurement

The analyzer can measure and display two traces for one channel, which allows four trace simultaneous display using the dual channel display capability. In addition, stimulus values (frequency, power) can range independently for each channel.

HP Instrument BASIC

This allows analyzer programmability without any external controller. HP Instrument BASIC is a subset of HP BASIC and allows all of the analyzer's measurement capabilities and any other HP-IB compatible instrument to be programmed. Option 002 HP Instrument BASIC keyboard is required to develop programs. For more information on HP Instrument BASIC, see *Using HP Instrument BASIC with the HP 87510A* furnished with the analyzer and *HP Instrument Users Handbook* furnished with Option 002.

I/O port

This allows the creation of a production line measurement system when used with an automatic handler. See Appendix C and Appendix D for more information.

Waveform Analysis Commands

The waveform analysis function provides filter and resonator specific measurement commands. These commands can be used to analyze filter ripple, obtain filter parameters (for example 3 dB bandwidth), or to search for a resonator's series-resonant mode frequency and its parallel-resonant mode (antiresonant) frequency and to derive parameters of the equivalent circuit of resonators. Executing a command derives parameters from measurement results and returns the derived parameters by HP-IB. An external controller or HP Instrument BASIC is required to use this command set. For more information on these commands, see *HP-IB Programming Manual*. Some of these commands can be executed from the front panel using **SPCL FNCT** key. For more information on **SPCL FNCT** key, see "**SPCL FCTN** Key" in Chapter 9.

Hewlett-Packard Interface Bus (HP-IB)

The analyzer is factory-equipped with a remote programming interface using the Hewlett-Packard Interface Bus (HP-IB). HP-IB is Hewlett-Packard's hardware, software, documentation, and support for IEEE-488.1, IEEE-488.2, IEC-625, and JIS-C1901 worldwide standards for interfacing instruments. This provides a remote operator with the same control of the instrument available to the local operator, except for control of the power line switch and some internal tests. Remote control is maintained by a controlling computer that sends commands or instructions to and receives data from the analyzer using HP-IB. Several output modes are available for output data. A complete general description of HP-IB is available in *Condensed description of the Hewlett-Packard Interface Bus* (HP part number 59401-90030), and in *the Tutorial Description of the Hewlett-Packard Interface Bus* (HP literature number 5952-0156).

The analyzer itself can use the HP-IB system to produce measurement results directly to a compatible printer or plotter without using an external computer.

Options Available

Option 001, High Stability Frequency Reference

This option, a 10 MHz crystal oscillator in a temperature stabilized oven, improves the source signal frequency accuracy and stability.

Option 002, Keyboard for HP Instrument BASIC

This option adds HP-HIL keyboard and cable for editing HP Instrument BASIC program on the HP 87510A display.

See the previous section for information.

Option 003, Type-N Input Connector

This option changes A channel input to type-N connector and provides probe power output for use with active probe and high input impedance adapter.

Option 004, Delete Reference Channel

This option deletes reference channel (R ch) input and one of two power splitter output.

Option 005, Parallel I/O Mode A

This option provides 8-bit output, 4-bit input parallel I/O with 15-pin HP 8751A compatible connector on the rear panel instead of standard parallel I/O (24-bit I/O). This option cannot be installed with option 006.

Option 006, Parallel I/O Mode B

This option provides 24-bit output, 8-bit input parallel I/O with 36-pin connector on the rear panel instead of standard 24-bit I/O. This option can not be installed with option 005.

Option 0B0, Delete Operation Manual

Option 907, Front Handle Kit

Option 908, Rack Mount Kit

This option is a rack mount kit containing a pair of flanges and the necessary hardware to mount the instrument, with handles detached, in an equipment rack with 482.6 mm (19 inches) horizontal spacing.

Option 909, Rack and Handle Kit

This option is a rack mount kit containing a pair of flanges and the necessary hardware to mount the instrument with handles attached in an equipment rack with 482.6 mm (19 inches) horizontal spacing.)

Option 0B1, Extra Operation Manual

This option is an extra manual set containing the same manual set which is furnished with the analyzer.

Option 0B3, Add Service Manual

This option adds Service Manual (HP Part Number: 87510-90031).

Measurement Accessories Available

Active Probes

HP 41800A Active Probe

This is a high input impedance probe for in-circuit measurement which covers the same frequency range as the HP 87510A. Option 003 on the HP 87510A is required to use this probe.

HP 41802A 1 M Ω Input Adapter

This adapter allows use of a high impedance probe. It has a frequency range of 100 kHz to 100 MHz. Option 003 on the HP 87510A is required to use this adapter.

System Accessories Available

System Rack

The HP 85043B system rack is a 124 cm (49 inch) high metal cabinet designed to rack mount the analyzer in a system configuration. The rack is equipped with a large built-in work surface, a drawer for calibration kits and other hardware, a bookshelf for system manuals, and a locking rear door for secured access. Lightweight steel instrument support rails support the instrument along their entire depth. Heavy-duty casters make the cabinet easily movable even with the instruments in place. Screw-down lock feet permit leveling and semi-permanent installation: the cabinet is extremely stable when the lock feet are down. Power is supplied to the cabinet through a heavy-duty grounded primary power cable, and to the individual instruments through special power cables included with the cabinet.

Plotters and Printers

The HP 87510A is capable of plotting displayed measurement results directly to a compatible peripheral without the use of an external computer. The compatible plotters are:

- HP 7440A Option 002 ColorPro Eight-Pen color graphics plotter, plots on ISO A4 or 8 1/2 × 11 inch charts.
- HP 7475A Option 002 six-pen graphics plotter, plots on ISO A4, A3 or 8 1/2 × 11 inch or 11 × 17 inch charts.
- HP 7550B Option 005 high-speed eight-pen graphics plotter, plots on ISO A4, A3 or 8 1/2 × 11 inch or 11 × 17 inch charts.

The compatible printers for both printing and plotting are:

- HP 3630A Paintjet Option 002 color printer
- HP 2225A (HP-IB compatible) ThinkJet printer
- HP 2227B QuietJet printer

HP-IB Cables

An HP-IB cable is required for interfacing the analyzer with a plotter, printer, computer, or other external instruments. The cables available are HP 10833A (1 m), HP 10833B (2 m), and HP 10833D (0.5 m).

Disks and Disk Accessories

Hewlett-Packard disks are listed below.

Table 2-1. Disks and Disk Accessories

HP Parts Number	Description
92192A	Box of 10 3.5 inch, 720K byte microfloppy disks
92192N	Box of 100 3.5 inch, 720K byte microfloppy disks
92192X	Box of 10 3.5 inch, 1.44M byte microfloppy disks

Instrument Specifications

These specifications are the performance standards or limits against which the instrument is tested. When shipped from the factory, the HP 87510A meets the specifications listed in this section. The specification test procedures are covered in the *HP 87510A Maintenance Manual*.

Note  Applicable frequency range of all specifications is from 100 kHz to 300 MHz, except for the applicable frequency range is noted.

Source

Frequency Characteristics

Range	100 kHz to 300 MHz
Accuracy	
at 23 ± 5°C	±20 ppm
at 0 to 55°C (with Opt. 001, 20 minutes after power on)	±1 ppm
Stability (at 23 ± 5°C)	
.....	±5 × 10 ⁻⁶ /day (Typ.)
Opt. 001, 48 hours after power on	±2.5 × 10 ⁻⁹ /8 hours (Typ.)
Resolution	1 mHz (Typ.)

Output Power Characteristics

Range	-15 to +5 dBm (Typ.)
Resolution	0.2 dB (Typ.)
Level Accuracy (at 23 ± 5°C, 0 dBm output level, 50 MHz)	± 1 dB
Flatness (at 23 ± 5°C, relative to 0 dBm output level at 50 MHz)	+2 dB, -4 dB
Linearity (at 23 ± 5°C, relative to 0 dBm output level at 50 MHz)	±1 dB

Power Splitter

Insertion Loss	
Nominal	6 dB
Output Tracking	
100 kHz ≤ Freq. ≤ 100 MHz	0.1 dB (Typ.)
100 MHz < Freq. ≤ 300 MHz	0.2 dB (Typ.)
Equivalent Output SWR	
100 kHz ≤ Freq. ≤ 100 MHz	≤ 1.2 (Typ.)
100 MHz < Freq. ≤ 300 MHz	≤ 1.4 (Typ.)

© 1999 Hewlett-Packard Company

Spectral Purity Characteristics

Harmonics (at -10 dBm output level)	< -35 dBc
Non-harmonic Spurious Signals (at 0 dBm output level, ≤ 300 MHz)	< -45 dBc
Phase Noise (at 10 kHz offset from 0 dBm fundamental)	< -75 dBc/Hz

Other Source Information

Reverse Power Protection	20 dBm, 50 Vdc (Typ.)
Output Connector	BNC female, 50 Ω (nominal), two channels

Receiver

Input Characteristics

Frequency Range	100 kHz to 300 MHz (Typ.)
Impedance	
Nominal	50 Ω
Return Loss	
100 kHz \leq Freq. < 100 MHz	> 20 dB
100 MHz \leq Freq. \leq 300 MHz	> 15 dB
Maximum Input Level	0 dBm (Typ.)
Damage Level	
DC	50 Vdc
AC	20 dBm
Noise Level (at 23 \pm 5 $^{\circ}$ C, Sweep Time mode is AUTO)	
IF BW 8 kHz	-70 dBm
IF BW 4 kHz	-85 dBm
IF BW 1 kHz	-90 dBm
IF BW 200 Hz	-100 dBm
IF BW 20 Hz	-110 dBm
IF Bandwidth (IF BW)	20 Hz, 200 Hz, 1 kHz, 4 kHz, and 8 kHz (Typ.)
Input Crosstalk (0 dBm input level).....	< -100 dB
Source Crosstalk (at +5 dBm output level)	< -110 dB(Typ.)
Residual Response (except for the following points)	< -90 dBm
170.14125 MHz, 170.9275 MHz, 227.379166667 MHz, and 228.4275 MHz	
Input Connector	BNC female, 50 Ω (nominal), two inputs (R and A)
Measurement Mode	A/R, A, R (Typ.)

Magnitude Characteristics

Absolute Characteristics

Display Range (Ref. value can be set to).....	± 500 dBm (Typ.)
Display Resolution (/div can be set to).....	0.001 dB/div to 500 dB/div (Typ.)
Marker Resolution	0.001 dB or 5 digits (Typ.)
Absolute Amplitude Accuracy (at 23 \pm 5 $^{\circ}$ C and -10 dBm input level)	± 1 dB

Ratio Characteristics

Display Range (Ref. value can be set to).....	±500 dB (Typ.)
Display Resolution (/div can be set to).....	0.001 dB/div to 500 dB/div (Typ.)
Marker Resolution	0.001 dB or 5 digits (Typ.)
Frequency Response (at 23 ± 5°C, -10 dBm input level)	
100 kHz ≤ Freq. ≤ 100 MHz	±0.5 dB
100 MHz < Freq. ≤ 300 MHz	±1.0 dB

Note Frequency response can be corrected by calibration.



Dynamic Accuracy (at 23 ± 5°C, 20 Hz IF BW, -10 dBm Rch input level, relative to -20 dBm Ach input level)

0 dBm ≥ Ach Input Level > -10 dBm	±0.4 dB
-10 dBm ≥ Ach Input Level > -20 dBm	±0.08 dB
-20 dBm ≥ Ach Input Level ≥ -50 dBm	±0.05 dB
-50 dBm > Ach Input Level ≥ -60 dBm	±0.06 dB
-60 dBm > Ach Input Level ≥ -70 dBm	±0.1 dB
-70 dBm > Ach Input Level ≥ -80 dBm	±0.3 dB
-80 dBm > Ach Input Level ≥ -90 dBm	±0.9 dB
-90 dBm > Ach Input Level ≥ -100 dBm	±3 dB
Trace Noise (at 1 kHz IF BW, -10 dBm input level)	< 10 mdB rms
Stability	0.02 dB/°C (Typ.)

Phase Characteristics

Measurement Mode	Normal/Expanded
Measurement Range	
Normal mode	±100 kdeg (no radian unit available)
Expanded mode	±5 Mdeg (no radian unit available)
Display Resolution	
Normal mode	0.01 deg/div to 500 deg/div
Expanded mode	10 pdeg/div to 10 kdeg/div
Marker Resolution	
Normal mode	0.01 deg.
Expanded mode	5 digits
Frequency Response (at 23 ± 5°C, deviation from linear phase, -10 dBm input level)	
100 kHz ≤ Freq. ≤ 100 MHz	±2.5 degree
100 MHz < Freq. ≤ 300 MHz	±5.0 degree

Note This specification is only for the deviation from linear phase. Frequency response can be corrected by calibration.



Dynamic Accuracy (at 23 ± 5°C, 20 Hz IF BW, -10 dBm Rch input level, relative to -20 dBm Ach input level)

0 dBm ≥ Ach input level > -10 dBm	±3 degree
-10 dBm ≥ Ach input level > -20 dBm	±0.5 degree
-20 dBm ≥ Ach input level ≥ -60 dBm	±0.3 degree
-60 dBm > Ach input level ≥ -70 dBm	±0.6 degree
-70 dBm > Ach input level ≥ -80 dBm	±1.8 degree
-80 dBm > Ach input level ≥ -90 dBm	±6 degree

-90 dBm > Ach input level ≥ -100 dBm ±18 degree
 Trace Noise (at 1 kHz IF BW, -10 dBm input level) < 50 mdeg rms
 Stability 0.05 deg/°C (Typ.)

Delay Characteristics

Aperture Frequency $\frac{200}{N-1}$ % to 100% of span, where N is Number of Points (Typ.)
 Display Range (Ref. value can be set to)..... ±10 psec to ±0.5 sec (Typ.)
 Display Resolution (/div can be set to) 10 fsec/div to 10 sec/div
 Accuracy (at = 23 ±5°C, Typical)

In general, the following formula can be used to determine the accuracy, in seconds, of a specific group delay measurement:

$$\frac{\text{Phase Accuracy[deg]}}{360[\text{deg}] \times \text{Aperture[Hz]}}$$

Depending on the aperture, input level, and device length, the phase accuracy used in either incremental phase accuracy or worst case phase accuracy.

General Characteristics

Operating Conditions

When disk drive is in operation

Temperature 10 to 50 °C

Humidity (at wet bulb ≤ 29°C, without condensation) 15% ≤ RH ≤ 80%

When disk drive is not in operation

Temperature 0 to 55 °C

Humidity (at wet bulb ≤ 29°C, without condensation) 15% ≤ RH ≤ 95%

Altitude 0 to 4,500 meters (15,000 feet)

Warm Up Time 30 minutes

Non-operating Conditions

Temperature -40 to 60 °C

Humidity (at wet bulb ≤ 29°C, without condensation) 15 % ≤ 95 %

Altitude 0 to 15,240 meters (50,000 feet)

Safety Based on IEC-348, UL 1244 certified by CSA 231

EMI Based on CISPR-11 Group1 Class A and FTZ 526/527

Line Power

Voltage Selector	Line Voltage	Line Frequency	MAX. VA
115 V	90 to 132 V	47 to 66 Hz	350
230 V	198 to 264 V	47 to 66 Hz	350

Weight 27 kg (Typ.)

Cabinet Dimensions 425(W) × 235(H) × 553(D) mm (Typ.)

ESD

Air discharge 8 kV

Contact discharge 4 kV

Rear Panel Specifications

I/O Buses

HP-IB Interface

ANSI/IEEE 488.2 compatible. There is no address switch.

I/O Port

See Appendix C in the *Reference Manual*.

BNC Connectors

“EXT REF INPUT 10/N MHz” Connector

This inputs a frequency reference to phase lock the analyzer to an external frequency standard.

Applicable input signal characteristics are:

Frequency	$\frac{10}{N}$ MHz ± 10 ppm, (N = 1, 2, 5, 10) (Typ.)
Amplitude	0 ± 5 dBm (Typ.)
Nominal Impedance	50 Ω

“REF OVEN (OPTION 001)” Connector

This outputs a frequency standard if Option 001 is installed. Output signal specifications are:

Frequency (at 0 to 55 °C, 20 minutes after power ON)	10 MHz ± 1.0 ppm (Typ.)
Amplitude	2 ± 5 dBm (Typ.)
Nominal Impedance	50 Ω

“INT REF OUTPUT” Connector

This outputs a frequency reference to an external instrument to phase lock it to the analyzer.

Output signal specifications follow:

Frequency (at 23 ± 5 °C)	10 MHz ± 20 ppm (Typ.)
Amplitude	0 ± 5 dBm (Typ.)
Nominal Impedance	50 Ω

“EXT TRIGGER” Connector

This triggers a measurement sweep.

Trigger signal specifications follow (See Figure 3-1):

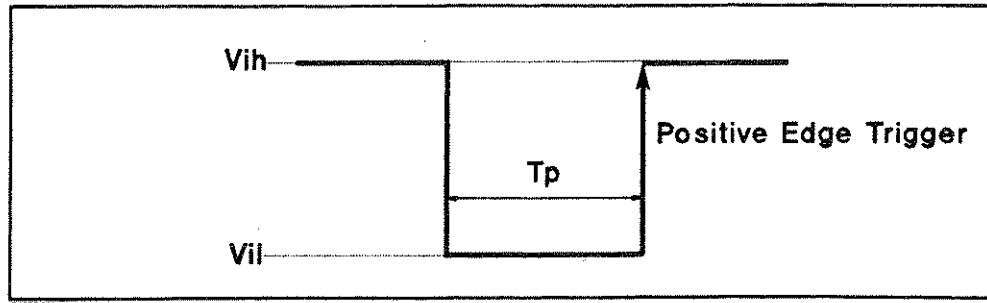

Figure 3-1. Trigger Signal

V_{ih}	+2 V to +5 V (Typ.)
V_{il}	0 V to +0.5 V (Typ.)
Sink current (I_s)	$I_s \leq 0.4$ mA (Typ.)
Pulse width (T_p)	$T_p \geq 20$ μ sec (Typ.)
Positive edge trigger	

“EXT PROG RUN/CONT” Connector

This externally triggers RUN/CONT of the Instrument BASIC program. The signal specifications are the same with the “EXT TRIGGER” connector.

Specifications when Option is Installed

Specifications When Option 003 Type N Connector Is installed

- The following specifications is changed.

Input Connector

Rch	BNC female, 50 Ω (nominal)
Ach	Type N female, 50 Ω (nominal)
Probe Power	+15 V (150 mA), -12.6 V (80 mA), GND (Typ.)

Specifications When Option 004 Delete Rch Is Installed

- The following specifications is deleted.

- “Power Splitter” in the “Output Power Characteristics” of the “SOURCE”
- “Input Crosstalk” in the “Input Characteristics” of the “Receiver”
- “Ratio Characteristics” in the “Magnitude Characteristics” of “Receiver”
- “Frequency Response”, “Trace Noise”, and “Stability” in the “Phase Characteristics” of the “Receiver”

- The following specifications is changed.

Output Return Loss	5 dB (Typ.)
Output Connector	One channel (RF OUT)

Input Connector	One Channel (Ach)
Measurement Mode	A
Magnitude Dynamic Accuracy (At $23 \pm 5^\circ\text{C}$, 20 Hz IF BW, assumption: reference is -20 dBm Ach input level, right after measuring reference)	
$0 \text{ dBm} \geq \text{Input Level} > -10 \text{ dBm}$	$\pm 0.4 \text{ dB}$
$-10 \text{ dBm} \geq \text{Input Level} \geq -60 \text{ dBm}$	$\pm 0.1 \text{ dB}$
$-60 \text{ dBm} > \text{Input Level} \geq -70 \text{ dBm}$	$\pm 0.2 \text{ dB}$
$-70 \text{ dBm} > \text{Input Level} \geq -80 \text{ dBm}$	$\pm 0.6 \text{ dB}$
Magnitude Stability	$0.05 \text{ dB}/^\circ\text{C}$ (Typ.)
Phase Dynamic Accuracy (at $23 \pm 5^\circ\text{C}$, 20 Hz IF BW, assumption: reference is -20 dBm Ach input level, right after measuring reference)	
$0 \text{ dBm} \geq \text{input level} > -10 \text{ dBm}$	$\pm 3 \text{ degree}$
$-10 \text{ dBm} \geq \text{input level} \geq -60 \text{ dBm}$	$\pm 1.5 \text{ degree}$
$-60 \text{ dBm} > \text{input level} \geq -70 \text{ dBm}$	$\pm 2.4 \text{ degree}$
$-70 \text{ dBm} > \text{input level} \geq -80 \text{ dBm}$	$\pm 3.6 \text{ degree}$
Phase Stability	$\pm 1 \text{ degree}/^\circ\text{C}$ (Typ.)

Furnished Accessories

Accessory	HP part number	Accessory	HP part number
Operation Manual	87510-90000	BNC Adapter ²	1250-1859
Maintenance Manual	87510-90030	Keyboard Template ³	08751-87111
Performance Test Program	87510-87001	ASCII Keyboard ³	HP 46021A
Sample Program Disk	87510-87002	ITF Keyboard Cable ³	46020-60001
BNC Cable	8120-1838	HP Instrument BASIC Manual Set ³	E2083-90000
Power Cable ¹			

1 power cable depends on where the instrument is used, see figure on the next page

2 Only option 001.

3 Only option 002.



<p>OPTION 900 United Kingdom</p>  <p>Plug: BS 1363A, 250V Cable: HP 8120-1351</p>	<p>OPTION 901 Australia/New Zealand</p>  <p>Plug: NZSS 198/AS C112, 250V Cable: HP 8120-1369</p>
<p>OPTION 902 European Continent</p>  <p>Plug: CEE-VII, 250V Cable: HP 8120-1688</p>	<p>OPTION 903 U.S./Canada</p>  <p>Plug: NEMA 5-15P, 125V, 15A Cable: HP 8120-1378</p>
<p>OPTION 904 U.S./Canada</p>  <p>Plug: NEMA 6-15P, 250V, 15A Cable: HP 8120-0698</p>	<p>OPTION 905* Any country</p>  <p>Plug: CEE 22-VI, 250V Cable: HP 8120-1396</p>
<p>OPTION 906 Switzerland</p>  <p>Plug: SEV 1011.1959-24507 Type 12, 250V Cable: HP 8120-2104</p>	<p>OPTION 912 Denmark</p>  <p>Plug: DHCR 107, 220V Cable: HP 8120-2956</p>
<p>OPTION 917 India/Republic of S.Africa</p>  <p>Plug: SABS 164, 250V Cable: HP 8120-4211</p>	<p>OPTION 918 Japan</p>  <p>Plug: JIS C 8303, 125V, 15A Cable: HP 8120-4753</p>
<p>NOTE: Each option number includes a 'family' of cords and connectors of various materials and plug body configurations (straight, 90° etc.).</p> <p>* Plug option 905 is frequently used for interconnecting system components and peripherals.</p>	

Figure 3-2. Power Cables Supplied

System Overview

System Overview

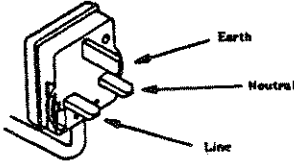
Network analyzers measure the reflection and transmission characteristics of devices and networks by applying a known swept signal and measuring the response of the test device. The signal transmitted through the device or reflected from its input is compared with the incident signal generated by a swept RF source. The signals are applied to a receiver for measurement, signal processing, and display. A network analyzer system consists of a source, signal separation devices, a receiver, and a display.

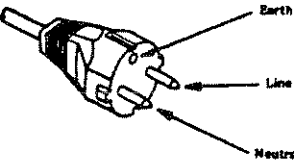
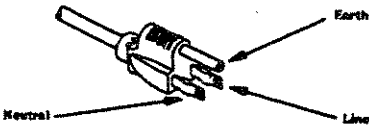
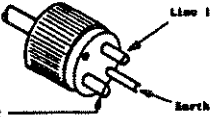
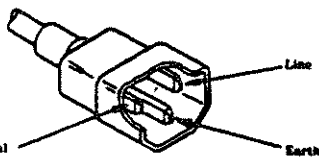
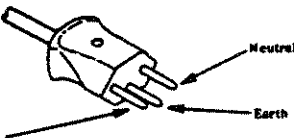
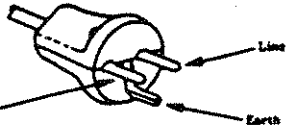
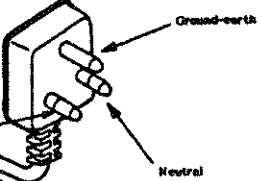
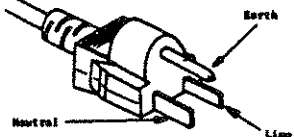
The HP 87510A Gain/Phase analyzer integrates a high resolution synthesized RF source with a built-in power splitter and a dual channel two-input receiver to measure and display magnitude, phase, and group delay of transmitted power. The HP 87510A has the capability of programming the measurement sequence and controlling other HP-IB instruments without an external controller. Other options are explained in Chapter 2. Figure 4-1 is a simplified block diagram of the gain phase analyzer system. A detailed block diagram of the analyzer is provided in the *Service Manual* (HP Part Number:87510-90031), together with theory of operation.

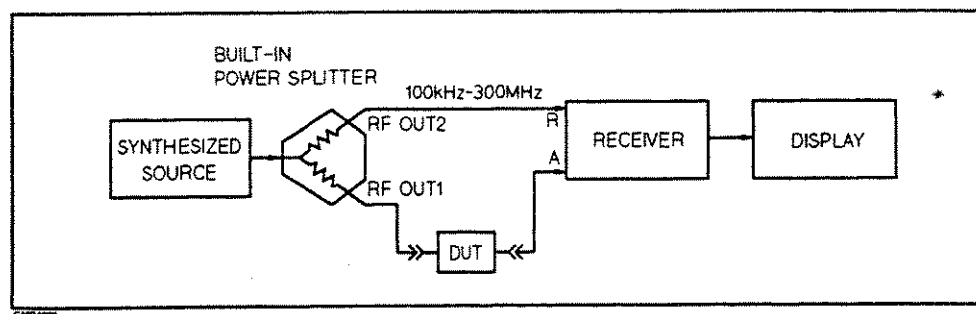

Figure 4-1. Simplified Block Diagram of the Network Analyzer System

Overall Operation

The source RF signal is transmitted through the device under test (DUT) and is then applied to receiver input A. The signal at receiver input A is compared to the original signal at receiver input R to characterize the DUT's transmission response.

The Built-In Synthesized Source

The analyzer's built-in synthesized source produces a swept RF signal in the range of 1 kHz to 300 MHz. To achieve frequency accuracy and phase measuring capability, the analyzer is phase-locked to a highly stable crystal oscillator.

The Built-in Power Splitter

The analyzer has a power splitter separate RF output signal to reference signal and incident signal.

The Receiver Block

The receiver block contains identical mixers for the R, and A inputs. The signals are mixed to produce a 10 kHz IF (intermediate frequency) which is converted to digital data for further processing. Both amplitude and phase information are measured simultaneously, regardless of what is displayed on the CRT.

The Microprocessors

The microprocessors take the raw data and perform all the required error correction, formatting, scaling, and marker operations, according to the instructions from the front panel. The formatted data is then displayed on the CRT. The data processing sequence is described below.

Data Processing

Overview

The analyzer's receiver converts the R, and A input signals into useful measurement information. This conversion occurs in two main steps. First, the swept high frequency input signals are translated to fixed low frequency IF signals, using analog mixing techniques. See "Theory of Operation" in the *Service Manual* for details. Second, the IF signals are converted into digital data by an analog-to-digital converter (ADC). From this point on, all further signal processing is performed mathematically by the analyzer's microprocessors. The following paragraphs describe the sequence of math operations and the resulting data arrays as the information flows from the ADC to the display. They provide a good foundation for understanding most of the response functions, and the order in which they are performed.

Figure 4-2 is a data processing flow diagram that represents the flow of numerical data from IF detection to display. The data passes through several math operations, denoted in the figure by single-line boxes. Most of these operations can be selected and controlled from the front panel RESPONSE block menus. The data is also stored in data arrays along the way, denoted by double-line boxes. These arrays are places in the flow path where data is accessible via HP-IB, using the built-in disk drive, and the RAM disk memory.

Important Concepts

- **Stimulus** is whatever is being measured on the display x-axis (frequency).
- A **data point** or **point** is a single piece of data representing a measurement at a single stimulus value. Most data processing operations are performed point-by-point; some involve more than one point.
- A **sweep** is a series of consecutive data point measurements, taken over a sequence of stimulus values. A few data processing operations require that a full sweep of data is available. The number of points per sweep is user defined, while the default number of points is 201. Note that the meaning of the stimulus values (independent variables) can change, depending on the *sweep type*, although this does not generally affect the data processing path. Examples of sweep types are linear frequency, logarithmic frequency and

frequency list mode. The frequency list mode allows you to choose specific stimulus points to be measured.

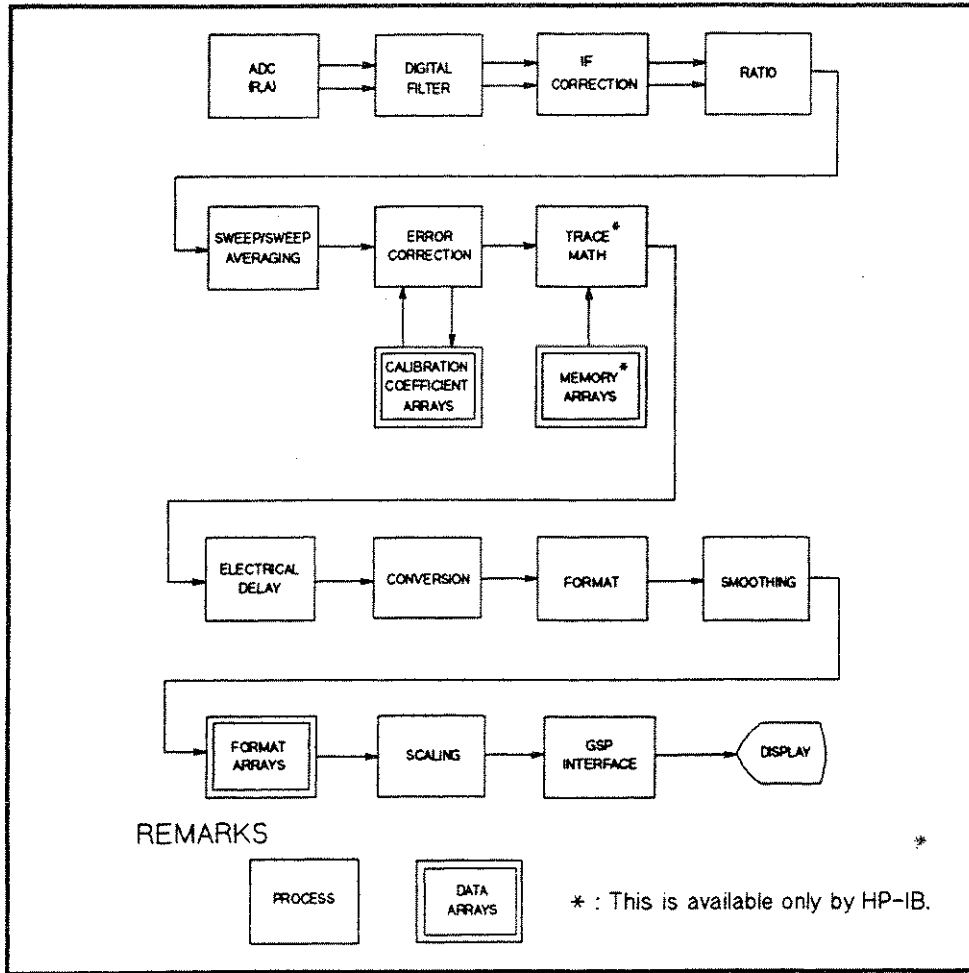

Figure 4-2. Data Processing Flow Diagram

Note



While only a single flow path is shown, two identical paths are available, corresponding to channel 1 and channel 2. When the channels are uncoupled, each channel can be independently controlled, so that the data processing operations for one can be different from the other.

Processing Details

The ADCs

The ADCs at both ports (R and A) convert an analog signal, which is already down-converted to a fixed low frequency IF, into digital data. See “MEAS Key” in Chapter 9 for more information on inputs.

Digital Filter

The digital filter detects the IF signal by performing a discrete Fourier transform (DFT) on the digital data. The samples are converted into complex number pairs, real plus imaginary, $R+jI$, which represent both the magnitude and phase of the IF signal. The filter shape can be

altered by selecting the IF bandwidth from among 20, 200, 1 k, 4 kHz and 8 kHz, which is a highly effective technique for noise reduction. See "**AVG** Key" in Chapter 9 for information on different noise reduction techniques.

IF Correction

This process digitally corrects for frequency response errors in the analog down conversion path.

Ratio Calculations

These are performed if the selected measurement is a ratio of *A* and *R* inputs. This is simply a complex divide operation. If the selected measurement is absolute (e.g. *A* or *R*), no operation is performed. The *R* and *A* values are also split into channel data at this point. See "**MEAS** Key" in Chapter 9 for more information.

Sweep-to-sweep Averaging

This is one of the noise reduction techniques. This calculation involves taking the complex exponential average of up to 999 consecutive sweeps. See "**AVG** Key" in Chapter 9.

Vector Error Correction (Accuracy Enhancement)

When a measurement calibration has been performed and correction is turned on, error correction removes repeatable systematic errors, stored in the calibration coefficient arrays, from the measurement data. This can vary from simple vector normalization to 3-term correction. See Chapter 10 for details.

The calibration coefficient arrays themselves are created during a measurement calibration. These are subsequently used whenever correction is ON, are accessible using by HP-IB, and can be saved to the built-in disk drive or the RAM disk memory.

The results of error correction are stored in the data arrays as complex number pairs. These arrays are accessible by HP-IB, and can be saved to the built-in disk drive and the RAM disk memory.

The Delay Block (Electrical Delay)

This involves adding or subtracting a linear phase in proportion to frequency. This is equivalent to "line-stretching" or artificially moving the measurement reference plane. See "**SCALE REF** Key" in Chapter 9 for details.

Conversion Transforms

Transforms measurement data into equivalent complex impedance (*Z*) or admittance (*Y*) values, to inverse parameters (*R/A*, *1/A* or *1/R*), or to phase multiples of 4, 8, or 16. See "Conversion Menu" in Chapter 9.

Formatting

This converts the complex number pairs into a scalar representation for display, according to the selected format. This includes group delay calculations. These formats are often easier to interpret than the complex number representation. (Polar chart format is not affected by the scalar formatting.) Note that after formatting, it is impossible to recover the complex data. See "**FORMAT** Key" in Chapter 9 for information on the different formats available and on group delay principles.

Smoothing

This is one of the noise reduction techniques used to smooth out noise on the trace. When smoothing is ON, each point in a sweep is replaced by the moving average value of several adjacent (formatted) points. The number of points included depends on the user defined smoothing aperture. The effect is similar to video filtering. See "**AVG** Key" in Chapter 9 for information about smoothing.

Format Arrays

The results so far are stored in the format arrays. It is important to note that marker values and marker functions are all derived from the format arrays. Limit testing is also performed on the formatted data. The format arrays are accessible by HP-IB, and can be saved to the built-in disk drive or the RAM disk memory.

Scaling

These operations prepare the formatted data for display on the CRT. This is where the reference line position, reference line value, and scale calculations are performed, as appropriate for the format being used. See "**SCALE REF** Key" in Chapter 9.

Display Memory

The display memory stores the display image for presentation on the display. The information here includes graticules, annotation, and softkey labels - everything visible on the display. When the display is printed or plotted, the information sent to the printer or plotter is taken from display memory. Finally, the display memory data is sent to the display.

of

of

of

Front and Rear Panel

Introduction

This chapter describes the analyzer operation using its front panel controls, and explains the use of softkey menus. It provides illustrations and descriptions of the front panel features, the CRT display and its labels, and the rear panel features and connectors.

Analyzer functions are activated from the front panel by the operator using front panel keys or softkeys. In this manual, all front panel keys and softkey labels are shown as **Hardkey** and **Softkey**.

Active Function

The function currently activated is called the active function, and is displayed in the active entry area at the upper left of the display. As long as a function is active it can be modified with the ENTRY keypad (See "Entry Block Keys" in Chapter 7). A function remains active until another function is selected, or **ENTRY OFF** is pressed.

Front Panel Keys and Softkey Menus

Some of the front panel keys change instrument functions directly, and others provide access to additional functions available in softkey menus. Softkey menus are lists of up to eight related functions that can be displayed in the softkey label area at the right-hand side of the display. The eight keys to the right of the CRT are the softkeys. Pressing one of the softkeys selects the adjacent menu function. This either executes the labeled function and makes it the active function, causes instrument status information to be displayed, or presents another softkey menu.

Some of the analyzer's menus are accessed directly from front panel keys, and some from other softkey menus. For example, the stimulus menu accessed by pressing the **MENU** key presents all the stimulus functions such as sweep type, number of points, power, sweep time, and trigger. Pressing **NUMBER of POINTS** allows the required number of points per sweep to be entered directly from the number pad. The **RETURN** softkeys returns to previous menus, while **DONE** both indicates completion of a specific procedure and returns to an earlier menu.

Usually, whenever a menu changes, the present active function is cleared, unless it is an active marker function.

Softkeys that are Joined by Vertical Lines

In cases where several possible choices are available for a function, they are joined by vertical lines. For example, in the input menu under the **MEAS** key, the available inputs and input combinations are listed: A, R, A/R, and only one can be selected at a time. When a selection has been made from the listed alternatives, that selection is underlined until another selection is made.

Softkeys That Toggle ON or OFF

Some softkey functions can be toggled ON or OFF, for example averaging, and this is indicated in the softkey label. The current state, ON or OFF, is capitalized in the softkey label.

Example:

AVERAGING ON off

The word ON is capitalized, showing that averaging is currently ON.

AVERAGING on OFF

The word OFF is capitalized, showing that averaging is currently OFF.

Softkeys that Show Status Indications in Brackets

Some softkey labels show the current status of a function in brackets. These include simple toggle functions and status-only indicators. An example of a toggled function is the **PLOT SPEED [FAST]** or **PLOT SPEED [SLOW]** softkey. The **IF BW** softkey is an example of a status-only indicator, where the selected value of the IF bandwidth is shown in brackets in the softkey label.

Function Key Blocks

The front panel keys that provide access to softkey menus are grouped into the **STIMULUS**, **RESPONSE**, and **INSTRUMENT STATE** function blocks.

Stimulus Block

The stimulus block keys and softkey menus control all the functions of the test signal source.

Response Block

The response block keys and softkey menus control the measurement and display functions specific to the active channel.

Instrument State Block

The instrument state block keys and softkey menus control channel-independent system function such as printing and plotting, save and recall, and HP-IB controller mode. In addition, major features such as limit testing, BIN sorting and Instrument BASIC are accessed under the **SYSTEM** key.

Instrument BASIC allows BASIC program entry using a full keyboard, to automate DUT measurement. Instrument BASIC may also be configured to run automatically at power on. This function also allows the operator to control external HP-IB instrument from the analyzer. *Using HP Instrument BASIC with HP 87510A* describes this feature.

HP-IB Control

The functions accessible from the front panel can also be accessed remotely by an external controller using HP-IB, or the Instrument BASIC function. Equivalent HP-IB commands are available for most of the front panel keys and softkey menu selections. The HP-IB programming command equivalent to each front panel and softkey function is provided in parentheses after the first reference. Additional information about HP-IB programming is provided in *HP-IB Programming Manual*.

Information on Keys and Softkeys

The following chapters describe all the front panel keys and softkey menus in detail. The purpose and use of each function is detailed, together with expected indications and results, allowable values, and possible limitations. This information is presented in function block order. Each function block is illustrated and described in general terms. This is followed by information about each front panel key in the function block, together with a map and description of all the menus accessed from that key. Each menu is illustrated, and each softkey function in each menu is explained in detail. A complete map of the softkey menu structure is provided in Appendix E at the end of this reference, together with an alphabetical index.

Front Panel Features

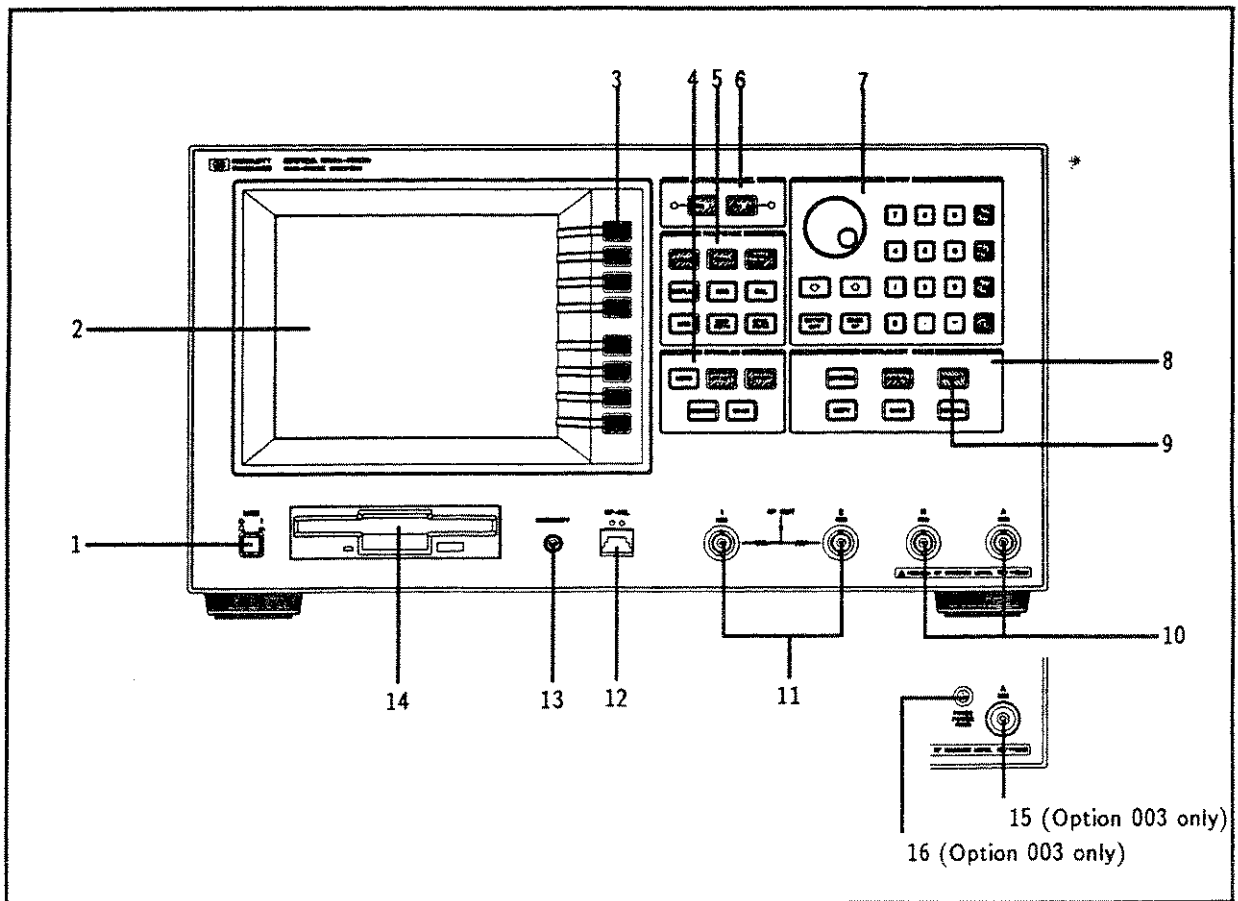

Figure 5-1. HP 87510A Front Panel

Figure 5-1 illustrates the following features and function blocks of the analyzer front panel. These features are described in more detail in this and subsequent chapters.

Caution



A properly grounded AC outlet is mandatory when operating the analyzer. Operating the instrument with an improperly grounded or floating ground prong **WILL DAMAGE THE INSTRUMENT!**

1. *LINE switch*. This controls AC power to the analyzer. 1 is ON, 0 is OFF.
2. *CRT display*. This is used for display of data traces, measurement annotation, softkey labels, and other information. The display is divided into specific information areas, illustrated in Figure 5-2.
3. *Softkeys*. These keys expand the capabilities of the analyzer with additional functions beyond those of the front panel keys. They provide access to menu selections displayed on the CRT.
4. *STIMULUS function block*. The keys in this block control the RF signal from the analyzer's source, and other stimulus functions.
5. *RESPONSE function block*. The keys in this block control the measurement and display functions of the active display channel.
6. *ACTIVE CHANNEL keys*. These keys select the active channel from two independent display channels. Any functions then entered apply to this active channel.
7. *The ENTRY block* includes the knob, the step \uparrow \downarrow keys, and the number pad. These keys are for entering numerical data and controlling the marker.
8. *INSTRUMENT STATE function block*. These keys control channel-independent system functions such as the following:
 - Limit testing (under the **SYSTEM** key).
 - Bin sorting (under the **SYSTEM** key).
 - Real time clock setting (under the **SYSTEM** key).
 - Instrument BASIC (under the **SYSTEM** key).
 - Changing the HP-IB addresses used by the analyzer when controlling external devices (printer, plotter). This is done through the **LOCAL** key.
 - Printing and plotting (under the **COPY** key).
 - Save/Recall, under their respective keys.
9. **PRESET** key. This key returns the instrument to a known standard preset state from any step of any manual procedure. A complete listing of the instrument preset conditions is provided in Appendix B.
10. *Inputs R and A*. These receive input signals from a test set, source, or device under test. Input R is used as the reference input. The input impedance of each input is 50 Ω .
11. *RF OUT connector 1 and 2*. These connect the RF output signal from the analyzer's internal source through the built-in power splitter. The output impedance at this connector is 50 Ω .
12. *Intensity*. This adjusts the intensity of the CRT display.
13. *HP-HIL connector*. This connects the keyboard (Option 002) to use Instrument BASIC.
14. *Built-in Flexible Disk Drive*. This stores the measurement data, instrument status, list sweep tables, and Instrument BASIC programs. The applicable disk formats are LIF (logical interchange format) and DOS format.

15. *Type-N Input A Connector (Option 003 only)*. Option 003 changes A channel input to type-N connector.
16. *Probe Power Connector (Option 003 only)*. This connector (fused inside the instrument) supplies power to an active probe for in-circuit measurements of AC circuits. Applicable active probes are described in Chapter 2.

CRT Display

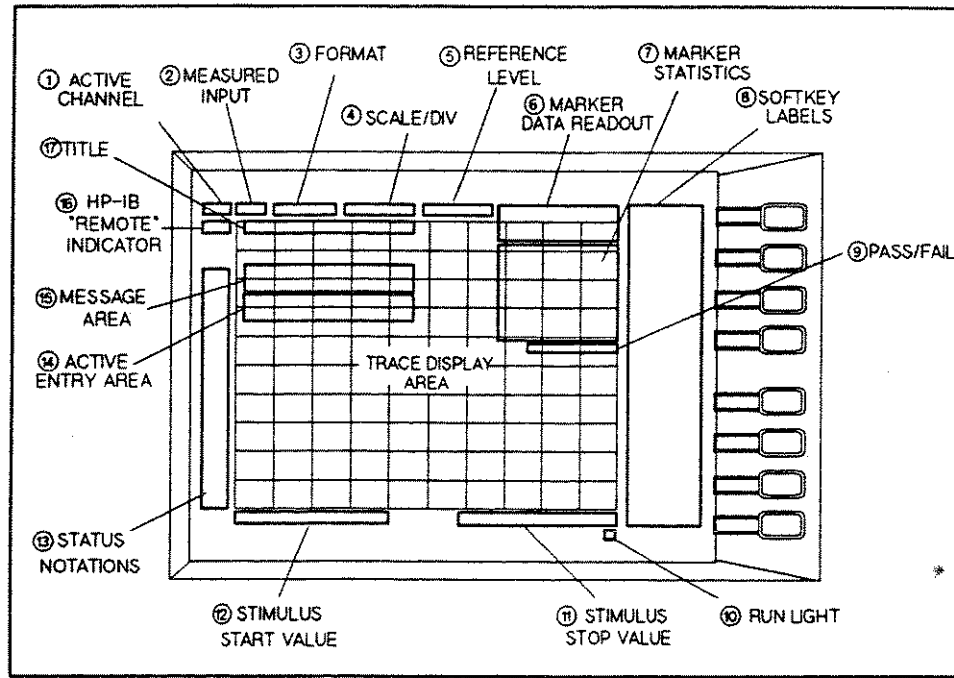

Figure 5-2. CRT Display (Single Channel, Cartesian Format)

The CRT displays the grid on which the measurement data is plotted, the currently selected measurement traces, and other information describing the measurement. Figure 5-2 illustrates the locations of the different CRT information labels, described below.

In addition to the full-screen display shown in Figure 5-2, a split display is available, as described under “**DISPLAY** Key” in Chapter 9. In this case, information labels are provided for each half of the display.

Several different display formats for different measurements are illustrated and described in “**FORMAT** Key” in Chapter 9.

The screen can also be used as the Instrument BASIC display. Instrument BASIC uses a full-screen display or a half-screen display below the graticule display as a text screen, and uses all of the screen as a graphics screen.

The following describe the information labels in detail.

1. *Active Channel* is the number of the current active channel, selected with the **ACTIVE CHANNEL** keys. If dual channel is ON with an overlaid display, both channel 1 and channel 2 appear in this area.

2. *Measured Input(s)* shows input, or ratio of inputs currently measured, as selected using the **MEAS** key. The current display memory status is also indicated in this area.
3. *Format* is the display format selected using the **FORMAT** key.
4. *Scale/Div* is the scale selected using the **SCALE REF** key, in units appropriate for the current measurement.
5. *Reference Level* is the value of a reference line in Cartesian formats or the outer circle in polar formats, selected using the **SCALE REF** key. However the reference line is invisible, it is indicated by a small triangle adjacent to the graticule at the left.
6. *Marker Data Readout* are the values of the active marker, in units appropriate to the current measurement. See Chapter 11.
7. *Marker Statistics, Width Value* are statistical marker values determined using the menus accessed with the **MKR FCTN** key. See Chapter 11 .
8. *Softkey Labels* are menu labels displayed on the CRT that redefine the function of the softkeys immediately to the right of the CRT.
9. *Pass/Fail* are used for limit testing using limit lines. See "Limit Line and Limit Testing" in Chapter 12.
10. *RUN LIGHT* indicates the status of the Instrument BASIC program.
 - (blank) Program stopped; can execute commands; CONTINUE not allowed.
 - Program paused; can execute commands; CONTINUE is allowed.
 - ? BASIC program waiting for input from keyboard; cannot execute commands.
 - * This indication has two possible meanings:
 - a. Program running; can NOT execute commands. CONTINUE not allowed.
 - b. System executing commanded entered from keyboard; can NOT enter commands.
11. *Stimulus Stop Value* is the stop frequency of the source. When the stimulus is in center/span mode, the span is shown in this space. The stimulus values can be blanked, as described under "**DISPLAY** Key" in Chapter 9.
12. *Stimulus Start Value* is the start frequency of the source. When the stimulus is in center/span mode, the center stimulus value is shown in this space.

13. *Status Notations* is the current status of various functions for the active channel. The following notations are used:

- Avg** Sweep-to-sweep averaging is ON. The averaging count is shown immediately below (see "**AVG**" Key" in Chapter 9).
- Cor** Error correction is ON (see Chapter 10).
- C?** Stimulus parameters have changed, and interpolated error correction is ON (see "**CAL**" Key" in Chapter 10).
- C!** Stimulus parameters have changed, and interpolated error correction is not available (see "**CAL**" Key" in Chapter 10).
- Del** Electrical delay, port extension, or phase offset has been added or subtracted (see "**SCALE REF**" Key" in Chapter 9).
- Ext** Waiting for an external trigger.
- Hld** Hold sweep (see "Trigger Menu" in Chapter 8).
- man** Waiting for manual trigger.
- Smo** Trace smoothing is ON (see "**AVG**" Key" in Chapter 9).
- Svc** A service mode is turned ON. If this notation is shown, the measurement data will be out of specifications. (*See Maintenance Manual.*)
- *** Source parameters changed: measured data in doubt until a complete fresh sweep has been taken.

14. *Active Entry Area* displays the active function and its current value.

15. *Message Area* displays prompts or error messages.

16. *HP-IB "REMOTE" Indicator* displays "RMT" when the analyzer is in the remote state.

17. *Title* is a descriptive alpha-numeric string title defined by the user and entered as described at "Title Menu" in Chapter 9 under "**DISPLAY**" Key" in Chapter 9.

Note

The information provided here applies to Cartesian display formats. In polar chart display format, the labeling may differ.



Rear Panel Features and Connectors

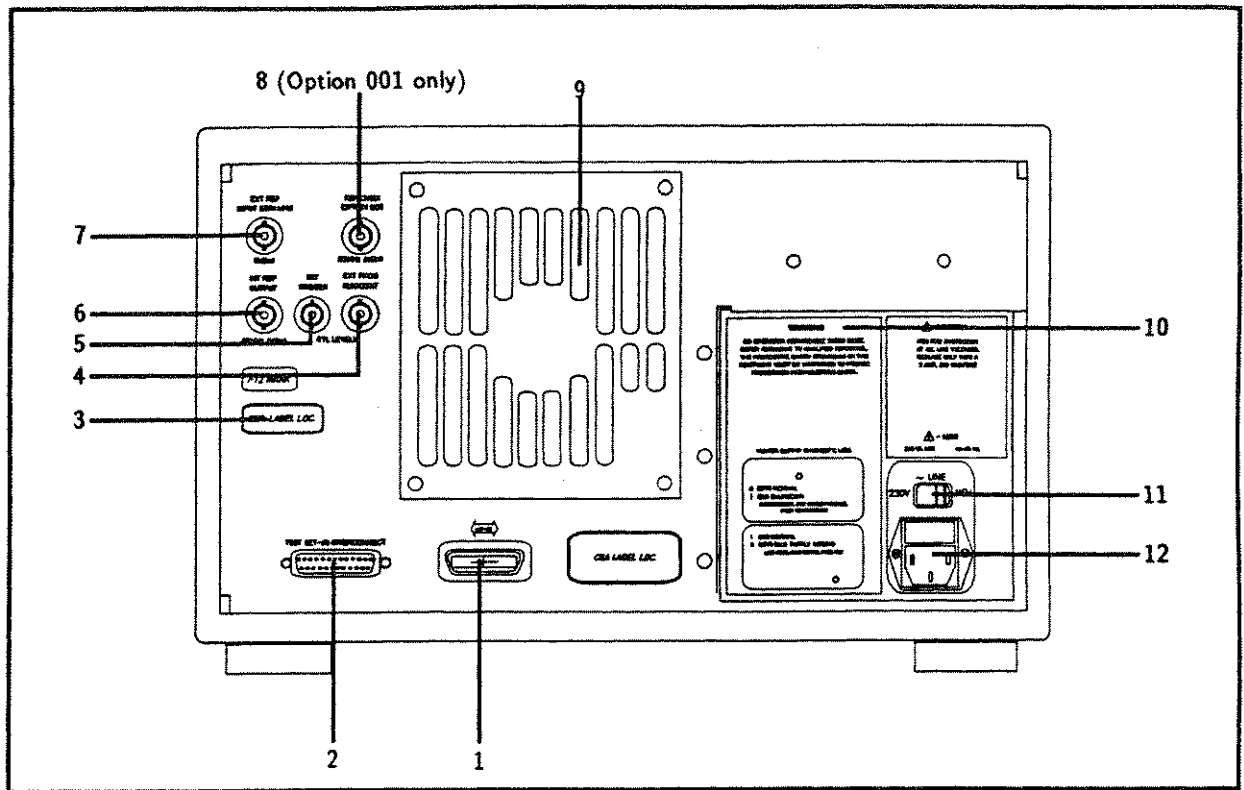

Figure 5-3. HP 87510A Rear Panel

Figure 5-3 illustrates the features and connectors of the rear panel, described below. Requirements for input signals to the rear panel connectors are provided in the General Characteristics table of the General Information and Specifications section.

1. *HP-IB connector.* This connects the analyzer to an external controller and other instruments in an automated system. This connector is also used when the analyzer itself is the controller of compatible peripherals. See Chapter 15.
2. *I/O port connector.* See Appendix C and D for complete information.
3. *Serial number plate.* For information about serial numbers, see "Instruments Covered by This Manual" in Chapter 2.
4. *EXT PROG RUN/CONT connector.* This externally triggers RUN or CONT of the Instrument BASIC program. At the positive-going edge of a pulse more than 20 μsec wide in the LOW state will trigger RUN or CONT. The signal is TTL-compatible.
5. *EXT TRIGGER connector.* This triggers a measurement sweep. At the positive-going edge of a pulse with more than 20 μsec wide in the LOW state will start a measurement. The signal is TTL-compatible. To use this connector, set the trigger mode to external using softkey functions (see "Trigger Menu" in Chapter 8).
6. *INT REF OUTPUT connector.* This connects a frequency reference input of an external instrument to phase lock it to the HP 87510A.
7. *EXT REF INPUT connector.* This inputs a frequency reference signal to phase lock the analyzer to an external frequency standard for increased frequency accuracy.

When the HP 87510A is equipped with the external oven (Option 001), this connector must be connected to the REF OVEN connector.

The external frequency reference feature is automatically enabled when a signal is connected to this input. When the signal is removed, the analyzer automatically switches back to its internal frequency reference.

8. *REF OVEN (Option 001) connector* connects to the EXT REF INPUT connector, when Option 001 is installed. Option 001 improves the frequency accuracy and stability of the analyzer.
9. *Fan.* This provides forced-air cooling for the analyzer.
10. *Safety warnings.*
11. *Line voltage selector switch.* See "Line Voltage" in the User's Guide.
12. *Power cord receptacle, with fuse.*



Active Channel Block

Active Channel Keys

The analyzer has two digital channels for independent measurement and display of data. Two different sets of data can be measured simultaneously, for example the reflection and transmission characteristics of a device, or one measurement with two different frequency spans. The data can be displayed separately or simultaneously, as described below.

The HP-IB programming command is shown in parenthesis following the key or softkey.

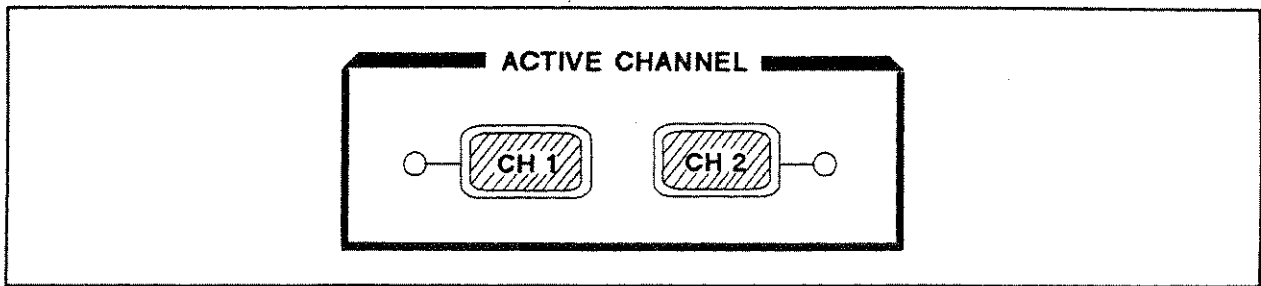

C4006001

Figure 6-1. Active Channel Keys

The **CH 1** (CHAN1) and **CH 2** (CHAN2) keys illustrated in Figure 6-1 select which channel is the *active channel*. This is the channel currently controlled by the front panel keys, and its trace and data annotations are displayed on the display. All channel specific functions selected apply to the active channel. The current active channel is indicated by an amber LED adjacent to the corresponding channel key.

The analyzer has dual trace capability, so that both the active and inactive channel traces can be displayed, either overlaid or on separate graticules (split display). The dual channel and split display features are available in the display menus. See Chapter 9 for illustrations and descriptions of the different display capabilities.

Stimulus values can be coupled or uncoupled between the two channels, independent of the dual channel and split display functions. Refer to “**MENU** Key” in Chapter 8 for a listing of the source values that are coupled in stimulus coupled mode.

Another coupling capability is coupled markers. Measurement markers can have the same stimulus values for the two channels, or they can be uncoupled for independent control of each channel. Refer to Chapter 11 for more information about markers.



Entry Block

Entry Block Keys

The ENTRY block, illustrated in Figure 7-1, provides the numeric and units keypad, the knob, and the step keys. These are used in combination with other front panel keys and softkeys to modify the active entry, to enter or change numeric data, and to change the value of the active marker. In general the keypad, knob, and step keys can be used interchangeably.

Before a function can be modified, it must be made the active function by pressing a front panel key or softkey. It can then be modified directly with the knob, the step keys, or the digits keys and a terminator, as described below.

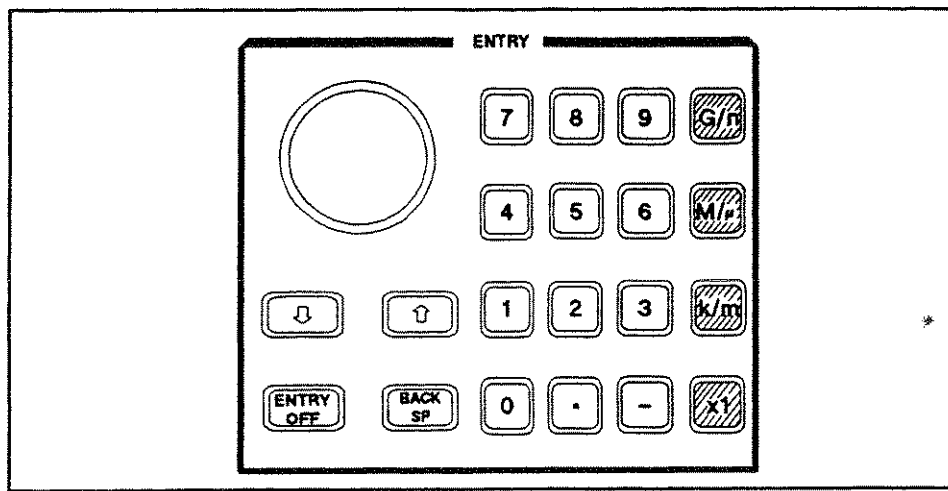

Figure 7-1. Entry Block

The numeric keypad selects digits, decimal point, and minus sign for numerical entries. A units terminator is required, as described below. The HP-IB programming command is shown in parenthesis following the key or softkey.

The units terminator keys are the four keys in the right-hand column of the keypad. These specify units of numerical entries from the keypad and at the same time terminate the entries. A numerical entry is incomplete until a terminator is supplied, and this is indicated by the data entry arrow "←" pointing at the last entered digit in the active entry area. When the units terminator key is pressed, the arrow is replaced by the units selected. The units are abbreviated on the terminator keys as follows:

G/n (G, N, KEY 43)	Giga/nano ($10^9 / 10^{-9}$)
M/μ (MA, U, KEY 42)	Mega/micro ($10^6 / 10^{-6}$)
k/m (K, M, KEY 41)	kilo/milli ($10^3 / 10^{-3}$)
x1 (KEY 40)	basic units: dB, dBm, degrees, seconds, Hz, or dB/GHz (may be used to terminate unitless entries such as averaging factor). No HP-IB commands are required.

Note The suffix unit MHZ is a special case which should not be confused with MAHZ (megahertz) or mHZ (microhertz).



The knob adjusts continuously to current values for various functions such as scale, reference level, and others. If a marker is turned on, and no other function is active, the knob can adjust the marker position. Values changed by the knob are effective immediately, and require no units terminator.

The step keys **↓** (KEY 24) and **↑** (KEY 25) step the current value of the active function up or down. The steps are predetermined and cannot be altered. No units terminator is required with these two keys.

ENTRY OFF (KEY 26) clears and turns off the active entry area, as well as any displayed prompts, error messages, or warnings. Use this function to clear the display before plotting. This key also prevents changing of active values by accidentally moving the knob. The next selected function turns the active entry area back on.

BACK SPACE key (KEY 27) deletes the last entry, or the last digit entered from the numeric keypad.

Stimulus Function Block

Introduction

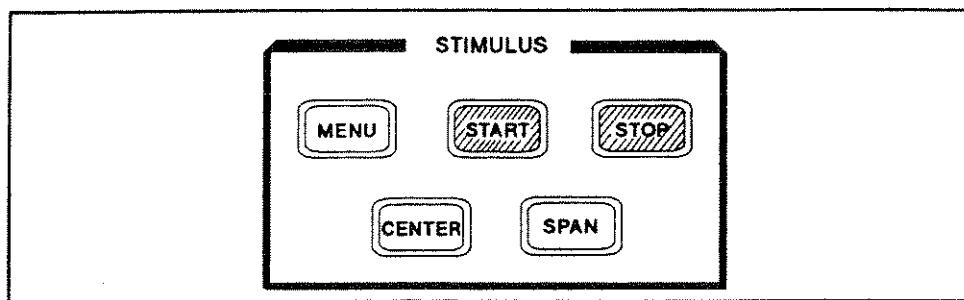

Figure 8-1. Stimulus Function Block

The stimulus function block keys and associated menus define and control the source RF output signal to the device under test (DUT). The source signal can be swept over any portion of the instrument's frequency range. The menus set all other source characteristics such as sweep time and resolution, source RF power level, and the number of data points taken during the sweep.

START, STOP, CENTER, and SPAN Keys

The HP-IB programming command is shown in parenthesis following the key or softkey.

START (STAR)

STOP (STOP)

CENTER (CENT)

SPAN (SPAN)

These keys define the frequency range of the stimulus. The range can be expressed as either Start/Stop or Center/Span. When one of these keys is pressed, its function becomes the active function. The value is displayed in the active entry area and can be changed with the knob, step keys, or numeric keypad. Current stimulus values for the active channel are also displayed along the bottom of the graticule. Frequency values can be a blank for security purposes, using the display menus.

The preset start and stop stimulus values are set to 100 kHz and 300 MHz respectively. The allowable frequency range is 1 kHz to 300 kHz.

Because the display channels are independent, the stimulus signals for the two channels can be uncoupled and their values set independently. The values are then displayed separately on the display if the analyzer is in dual channel display mode. In the uncoupled mode with

dual channel display the analyzer takes alternate sweeps to measure the two sets of data. Channel stimulus coupling is explained in this chapter, and dual channel display capabilities are explained in Chapter 9 .

MENU Key

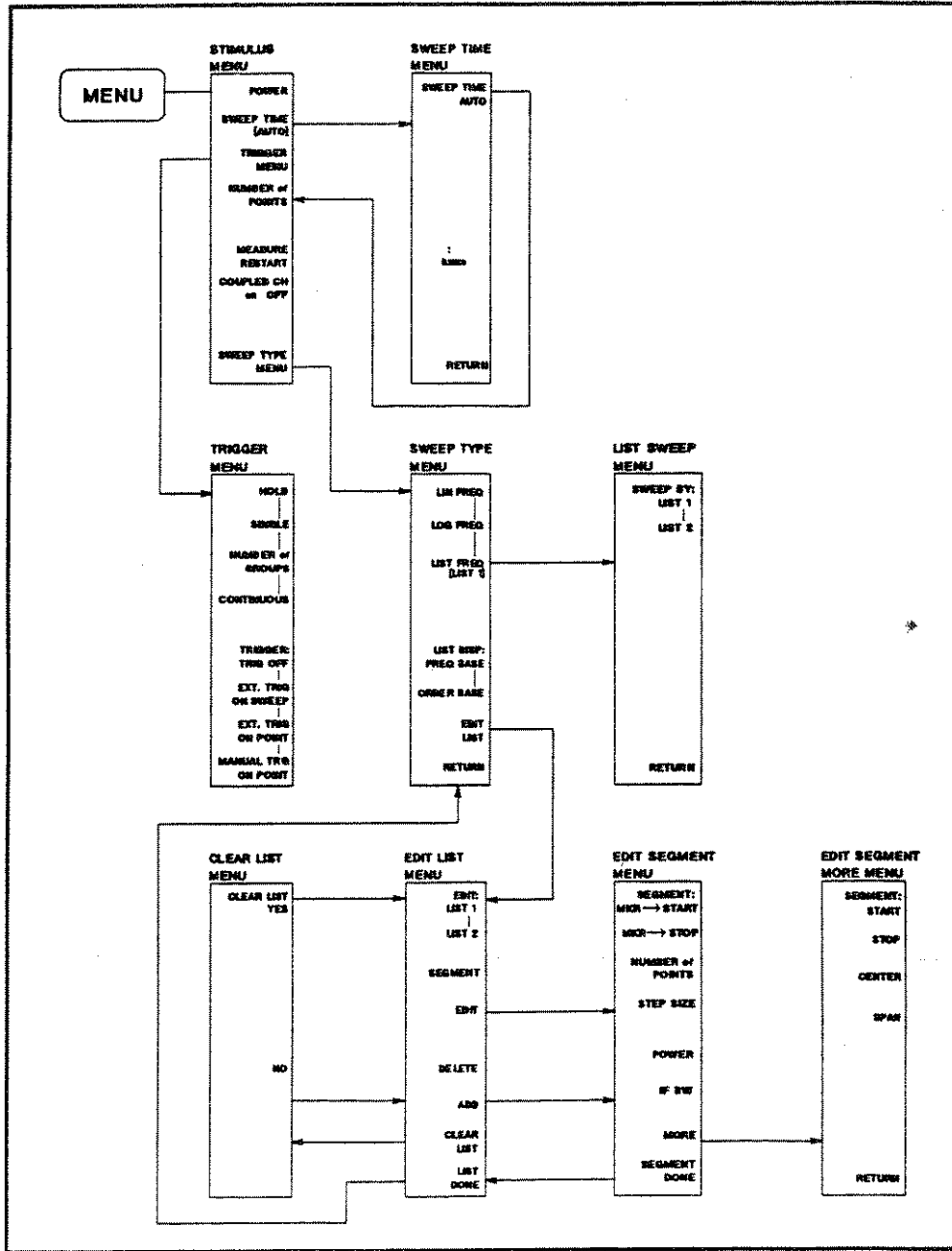

Figure 8-2. Softkey Menus Accessed from the **MENU** Key

The HP-IB programming command is shown in parenthesis following the key or softkey.

The **MENU** (KEY 19) key provides access to the series of menus illustrated in Figure 8-2, which define and control all stimulus functions other than Start, Stop, Center, and Span. When the **MENU** key is pressed, the stimulus menu is displayed. This in turn provides access to the other softkey menus. The functions available in these menus are described in the following paragraphs.

Stimulus Menu

The stimulus menu specifies power level, the number of measurement points per sweep. It includes the capability to couple or uncouple the stimulus functions of the two display channels, and the measurement restart function. In addition, it leads to other softkey menus that define sweep time, trigger type, and sweep type. The individual softkey functions of the stimulus menu are described below.

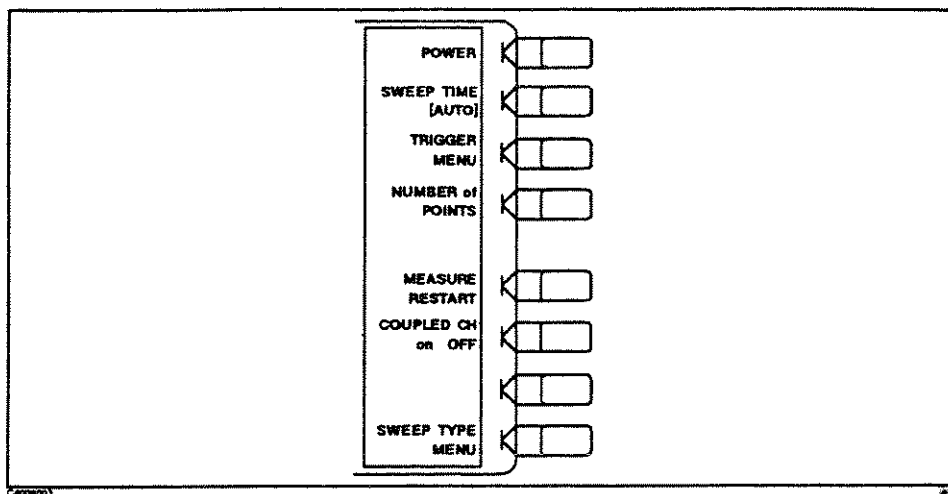

Figure 8-3. Stimulus Menu

POWER (POWE) makes power level the active function, which sets the output power level. The allowable power range is -15 dBm to $+5$ dBm.

SWEEP TIME [] (SWET) makes sweep time value the active function and presents the sweep time menu, which toggles between automatic and manual sweep time.

TRIGGER MENU presents the trigger menu, which selects the type of the sweep trigger.

NUMBER of POINTS (POIN) selects the number of data points per sweep. Using fewer points allows a faster sweep time but the displayed trace shows less horizontal detail. Using more points gives greater data density and improved trace resolution, but slows the sweep.

The possible values that can be entered for number of points are 2 through 801 with a step value of 1. The number of points can be different for the two channels if the stimulus values are uncoupled.

In list frequency sweep, the number of points displayed is the total number of frequency points for the defined list (see "Sweep Type Menu" in this chapter).

MEASURE RESTART (REST) aborts the sweep in progress, then restarts the measurement. This can update a measurement following an adjustment of the device under test.

If the analyzer is taking a number of groups (see "Trigger Menu" in this chapter), the sweep counter is reset to 1. If averaging is ON, **MEASURE RESTART** resets the sweep-to-sweep averaging and is effectively the same as **AVERAGING RESTART**.

If the sweep trigger is in the **HOLD** mode, **MEASURE RESTART** executes a single sweep. If **DUAL CHAN** is ON (screen displays both measurement channels), **MEASURE RESTART** executes a single sweep to both channels even if **COUPLED CH** is OFF.

COUPLED CH on OFF (COUCON, COUCOFF) toggles the channel coupling of stimulus values. With **COUPLED CH ON** (the preset condition), both channels have the same stimulus values (the inactive channel takes on the stimulus values of the active channel).

In the stimulus coupled mode, the following parameters are coupled:

- Frequency
- Number of points
- Source power level
- Number of groups
- IF bandwidth
- Sweep time
- Trigger type
- Sweep type
- List sweep table

If both channels have the same input parameter such as A/R and A, the following parameters are also coupled:

- Correction mode
- Calibration coefficient

The following parameters are always common to both channels, even if the stimulus mode is not coupled.

- External trigger mode
- Calibration kit type and data

The following parameters are always set separately for each channel, even if the stimulus mode is coupled.

- Measurement parameter
- Display Format
- Title (on/off)
- Scale reference value
- Electrical delay
- Phase offset
- Averaging (on/off, factor)
- Smoothing (on/off, factor)

Coupling of stimulus values for the two channels is independent of **DUAL CHAN on OFF** in the display menu and **MARKERS: UNCOUPLED** in the marker mode menu. **COUPLED CH OFF** becomes an alternate sweep function when dual channel display is ON: in this mode the analyzer alternates between the two sets of stimulus values for measurement of data and both are displayed.

SWEEP TYPE MENU presents the sweep type menu, where one of the available types of stimulus sweep can be selected.

Sweep Time Menu

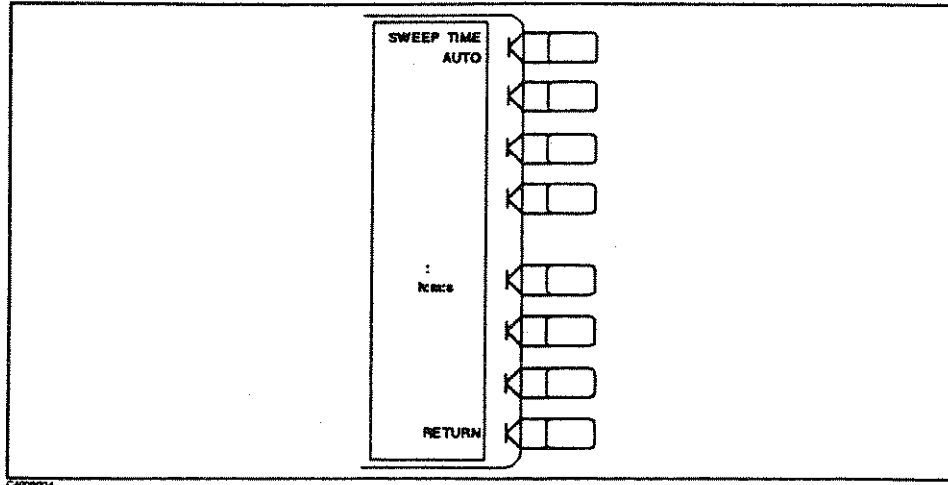

Figure 8-4. Sweep Time Menu

SWEEP TIME AUTO (SWETAUTO) selects the proper sweep time automatically. The following explains the difference between automatic and manual sweep time:

- **Manual Sweep Time.** As long as the selected sweep speed is within the capability of the instrument, it will remain fixed, regardless of changes in other measurement parameters. If the operator changes measurement parameters such that the instrument can no longer maintain the selected sweep time, the analyzer will change to the best sweep time possible. Manual mode is turned ON by entering a sweep time.
- **Auto Sweep Time.** Auto sweep time continuously maintains the fastest sweep speed possible with the selected measurement parameters to satisfy the specifications. Auto sweep time is turned ON by pressing **SWEEP TIME AUTO** (SWETAUTO) when manual sweep is ON.

Sweep time refers only to the time that the instrument is sweeping and taking data, and does not include the time required for internal processing of the data. A sweep speed indicator "↑" is displayed on the trace for sweep times slower than 1.0 second.

Minimum sweep time. The minimum sweep time depends on several factors. These factors are referred to as "measurement parameters" in the following paragraphs.

- The number of points selected
- IF bandwidth

The following table is a partial guide for determining the minimum sweep time. The typical values listed represent the minimum time required for a measurement with averaging OFF. Values are given in seconds.

Table 8-1. Minimum Sweep Time In Seconds (Typical Value)

Number Of Points	IF Bandwidth				
	8 kHz	4 kHz	1 kHz	200 Hz	20 Hz
11	2.75 m	4.4 m	11 m	37.4 m	565.4 m
51	12.75 m	20.4 m	51 m	173.4 m	2.621
101	25.25 m	40.4 m	101 m	343.4 m	5.191
201	50.25 m	80.4 m	201 m	633.4 m	10.331
401	100.25 m	160.4 m	401 m	1.363	20.611
801	200.25 m	320.4 m	801 m	2.723	41.171

: h:m:s inputs ":" for the manual sweep time entry.

RETURN goes back to the stimulus menu.

Trigger Menu

This menu selects the type of the sweep trigger.

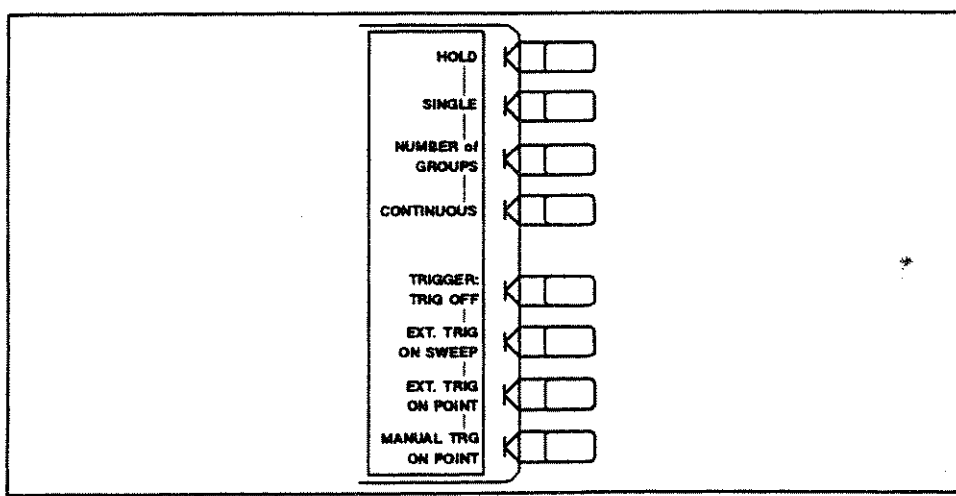

Figure 8-5. Trigger Menu

HOLD (HOLD) freezes the data trace on the display, and the analyzer stops sweeping and taking data. The notation "Hld" is displayed at the left of the graticule. If the "*" indicator is ON at the left side of the display, trigger a new sweep using **SINGLE**.

SINGLE (SING) takes one sweep of data and returns to the hold mode.

NUMBER of GROUPS (NUMG) triggers a user-specified number of sweeps, and returns to the hold mode.

If averaging is ON, the number of groups should be at least equal to the averaging factor selected to allow measurement of a fully averaged trace. Entering a number of groups resets the averaging counter to 1.

CONTINUOUS (CONT) is the standard sweep mode of the analyzer, in which the sweep is triggered automatically and continuously and the trace is updated with each sweep.

TRIGGER: TRIG OFF (EXTTOFF) turns OFF the external trigger mode.

EXT. TRIG ON SWEEP (EXTTON) is used when the sweep is triggered on an externally generated signal input through the rear panel EXT TRIGGER input. The sweep is started with a low-to-high transition of a TTL signal. If this key is pressed when no external trigger signal is connected, the notation "Ext" is displayed at the left side of the display to indicate that the analyzer is waiting to be triggered. When a trigger signal is connected, the "Ext" notation is replaced by the sweep speed indicator "↑" either in the status notations area or on the trace. External trigger mode is allowed in every sweep mode.

EXT. TRIG ON POINT (EXTTPOIN) is similar to the trigger on sweep, but triggers each data point in a sweep.

MANUAL TRG ON POINT (MANTRIG) waits for a manual trigger for each point. Subsequent pressing of this softkey triggers each measurement. The annotation "man" will appear at the left side of the display when the instrument is waiting for the trigger to occur.

Sweep Type Menu

Three sweep types are available:

- Linear frequency sweeps
- Logarithmic frequency sweeps
- List frequency sweep. Two independent lists are available.

Interpolated Error Correction. The interpolated error correction feature functions with all sweep types.

Interpolated error correction automatically turns ON when the stimulus parameters are changed after measuring calibration data. See Chapter 10 for more information on interpolated error correction.

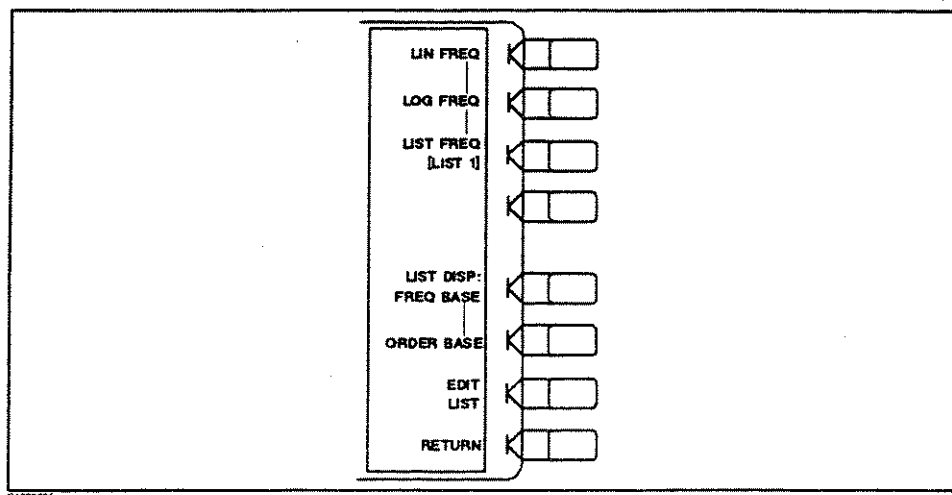

Figure 8-6. Sweep Type Menu

LIN FREQ (LINFREQ) activates a linear frequency sweep mode. The data is displayed on a standard graticule with ten equal horizontal divisions. This is the default preset sweep type.

LOG FREQ (LOGFREQ) activates a logarithmic frequency sweep mode. The source is stepped in logarithmic increments and the data is displayed on a logarithmic graticule.

LIST FREQ [LIST 1] or **LIST FREQ [LIST 2]** (LISFREQ) shows the active list number and activates the frequency list mode, and presents the "List Sweep Menu" if two frequency lists have been defined.

Frequency list mode allows you to measure DUT response over several distinct frequency ranges or at specific frequency points. Each entry in the frequency list is called a *SEGMENT*, regardless of it being a frequency range or single point. Each segment can specify the number of points, source power level, and IF bandwidth. Up to 31 segments can be specified in any combination in one of two independent lists.

Before using frequency list mode, the frequency list must be created. See "Edit List Menu", "Edit Segment Menu", and "Edit Segment More Menu" later in this chapter for entering and modifying the lists.

A tabular printout of the frequency list data can be obtained using the **LIST SWEEP TABLE** function in the copy more menu.

LIST DISP: FREQ BASE (LISDFBASE) displays data measured as frequency base in the frequency list mode. The frequency scale is linear across the total range. Since the frequency points may not distribute evenly across the graticule, the display resolution may be uneven, and more compressed in some parts of the trace than in others.

ORDER BASE (LISDOBASE) displays data measured as order base in the frequency list mode. The displayed frequency resolution is even across the graticule, even though the frequency points are not distributed evenly.

EDIT LIST (EDITLIST) presents the edit list menu. This is used in conjunction with the edit segment menu to define or modify the frequency sweep list. The list frequency sweep mode is selected with the **LIST FREQ [LIST 1]** or **LIST FREQ [LIST 2]** softkey described above.

RETURN goes back to the stimulus menu.

List Sweep Menu

This menu activates one of the frequency lists to be swept. If there is only one list, or no list is defined, the menu will not be provided.

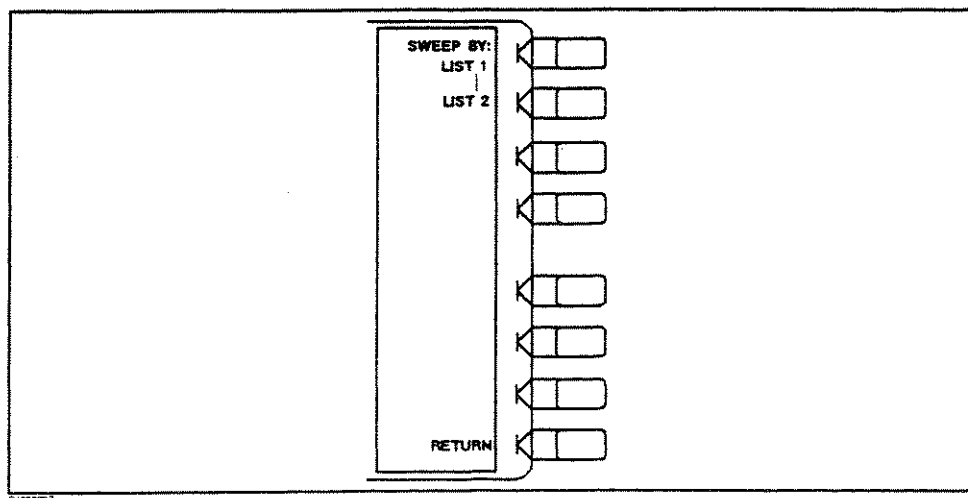

Figure 8-7. List Sweep Menu

SWEEP by:LIST 1 (LISSLIS1) activates LIST 1 for the list sweep.

LIST 2 (LISSLIS2) activates LIST 2 for the list sweep.

RETURN goes back to the sweep type menu without any change.

Edit List Menu

This menu edits the list of frequency segments (subsweep) defined with three other menus. Each of two lists can specify up to 31 frequency segments, for a maximum of 801 points. The segments do not have to be entered in any particular order: the analyzer automatically sorts them and lists them on the display in increasing order of start frequency. This menu determines which segment on the list is to be modified, while other menus change the frequency range, number of points, power level and IF bandwidth of the selected segment.

Note



The list and segment data are cleared on instrument preset, cycling the power and instrument state recall. The list and segment data can be saved with the built-in Flexible disk drive and the RAM disk memory. (See Chapter 14).

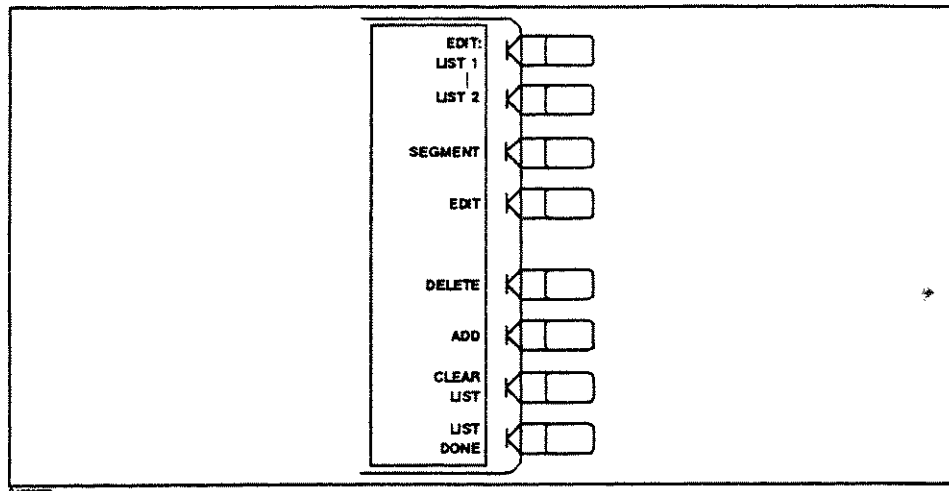

Figure 8-8. Edit List Menu

EDIT:LIST 1 (EDITLIS1) selects LIST 1 to edit.

LIST 2 (EDITLIS2) selects LIST 2 to edit.

SEGMENT (SEDI) determines a segment on the list to be modified. Enter the number of a segment in the list, or use the step keys to scroll the pointer ">" at the left to the required segment number. The indicated segment can then be edited or deleted.

EDIT provides the edit segment menu, where the segment indicated by the pointer ">" at the left can be modified.

DELETE (SDEL) deletes the segment indicated by the pointer ">".

ADD (SADD) adds a new segment to be defined with the edit segment menu. If the list is empty, a default segment is added, and the edit segment menu is displayed so it can be modified. If the list is not empty, the segment indicated by the pointer ">" is copied and the edit segment menu is displayed.

CLEAR LIST (CLEL) provides the clear list menu.

LIST DONE (EDITDONE) sorts the frequency points and returns to the sweep type menu.

Edit Segment Menu

This menu is used to select arbitrary measurement frequencies. Using this menu it is possible to define the exact frequencies to be measured on a point-by-point basis. For example the sweep could include 100 points in a narrow pass-band, 100 points across a broad stop band, and 50 points across the third harmonic response. The total sweep is defined with a list of segments (subsweeps). Up to 31 segments can be defined, with a total of up to 801 data points.

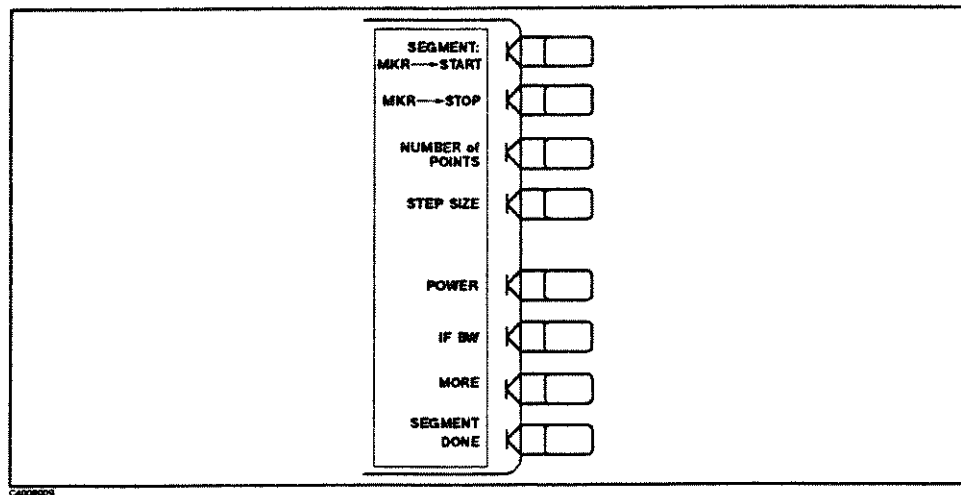

Figure 8-9. Edit Segment Menu

The frequency segments, or segments, can be defined in any of the following terms:

- Start / stop / number of points
- Start / stop / step
- Center / span / number of points
- Center / span / step

The segments can overlap, and do not have to be entered in any particular order. The analyzer sorts the segments automatically and lists them on the display in order of increasing start frequency, regardless of the order in which they are entered. If duplicate frequencies exist, the analyzer makes multiple measurements on identical points to maintain the specified number of points for each segment. The data is displayed as a single trace that is a composite of all data taken when the list display function is frequency base.

The list frequency sweep mode is selected with the **LIST FREQ** softkey in the sweep type menu.

The frequency list parameters can be saved with the built-in floppy disk and the RAM disk memory. (See Chapter 14.)

Note

Not only the softkeys described below, use also the **START**, **STOP**, **CENTER**, and **SPAN** keys to define the stimulus range.



MKR → START (MARKSTAR) sets the stimulus start value to the stimulus value of the active marker.

MKR → STOP (MARKSTOP) sets the stimulus stop value to the stimulus value of the active marker.

NUMBER of POINTS (POINT) sets the number of points for the segment. The total number of points for all the segments cannot exceed 801.

STEP SIZE (STPSIZE) specifies the segment in frequency steps instead of number of points. Changing the start frequency, stop frequency, span, or number of points may change the step size. Changing the step size may change the number of points and stop frequency in start/stop/step mode; or the frequency span in center/span/step mode. In each case, the frequency span becomes a multiple of the step size.

SEGMENT POWER (POWE) sets power level for segment by segment. The allowable range is -15 dBm to +5 dBm.

IF BW (IFBW) sets IF bandwidth for segment by segment. The allowable bandwidths are 20, 200, 1 k, 4 kHz, and 8 kHz.

MORE goes to the edit segment more menu, which allows the stimulus range values to be entered using the Entry keys, Start, Stop, Center, and Span.

SEGMENT DONE (SDON) returns to the edit list menu.

Edit Segment More Menu

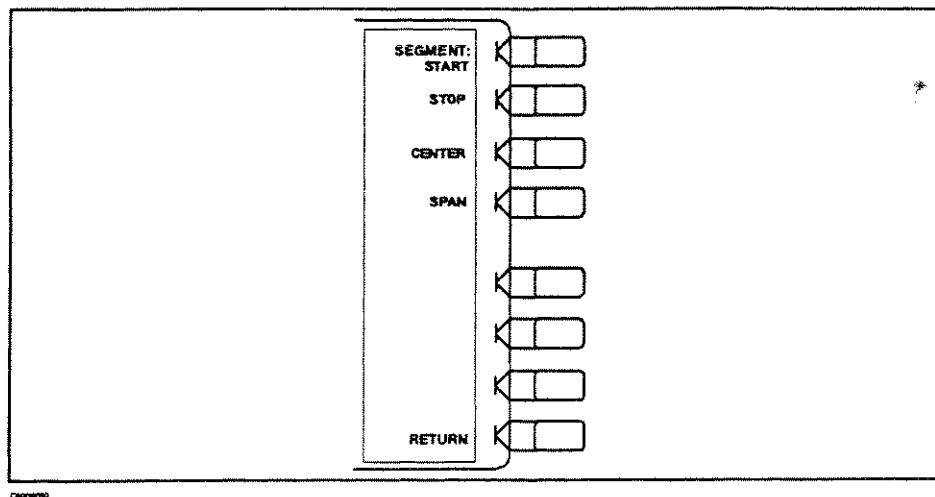

Figure 8-10. Edit Segment More Menu

SEGMENT START (STAR) sets the START frequency of a segment.

STOP (STOP) sets the STOP frequency of a segment.

CENTER (CENT) sets the CENTER frequency of a segment.

SPAN (SPAN) sets the frequency SPAN of a segment about a specified center frequency.

RETURN goes back to the edit segment menu.

Clear List Menu

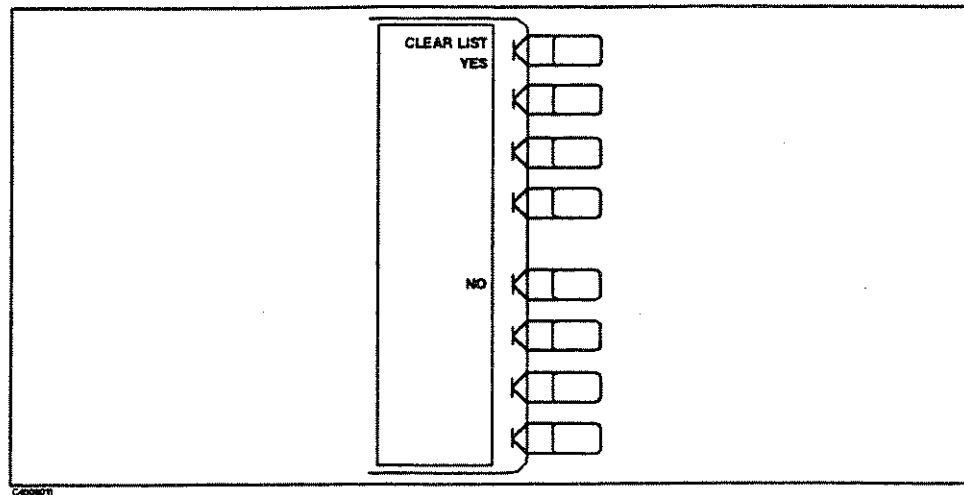

Figure 8-11. Clear List Menu

CLEAR LIST YES (CLEL) clears the entire list.

NO cancels and goes back to the edit list menu.

Response Function Block

Introduction

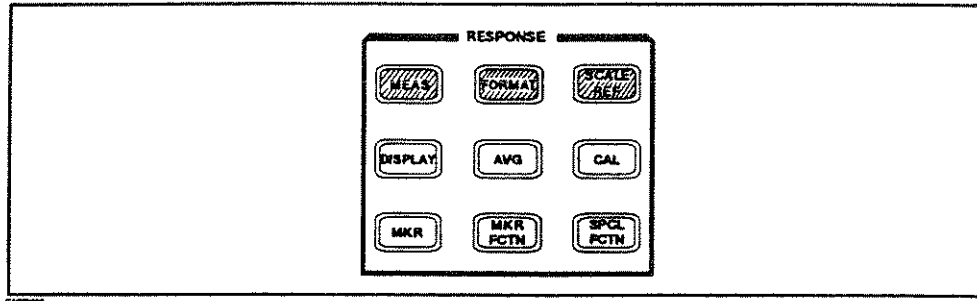

Figure 9-1. Response Function Block

The keys in the *RESPONSE* block control the measurement and display functions of the active channel. They provide access to many different softkey menus that offer selections for the measuring parameters, the display mode and data format, the control of the display markers, a variety of calibration functions, and some wave form analysis functions.

The HP-IB programming command is shown in parenthesis following the key or softkey.

The current values for the major response functions of the active channel are displayed in specific locations along the top of the display. In addition, certain functions accessed through the keys in this block are annotated in the status notations area at the left side of the display. The locations of these information labels are described in Chapter 5.

The *RESPONSE* block keys and their associated menus are described briefly below, and in more detail in this and the following chapters.

The **(MEAS)** key provides access to a series of softkey menus for selecting the parameters or inputs to be measured.

The **(FORMAT)** key leads to a menu which selects the display format for the data. Various rectangular and polar formats are available for display of magnitude, phase, impedance, group delay, real data, and imaginary data.

The **(SCALE REF)** key displays a menu which modifies the vertical axis scale and the reference line value as well as electrical length and phase offset.

The **(DISPLAY)** key leads to a series of menus for instrument and active channel display functions. This menu include dual channel display (overlaid or split), active channel display title, trace display ON/OFF, graticule display ON/OFF, and frequency blanking.

The **(AVG)** key accesses three different noise reduction techniques: sweep-to-sweep averaging, trace smoothing, group delay aperture, and variable IF bandwidth.

The **(SPCL FCTN)** key provides the special function menu, that quickly gets certain measurement parameters without going through the usual key sequence.

The **CAL** key, **MKR** and **MKR FCTN** keys are explained later. For information on **CAL**, see Chapter 10. For information on **MKR**, and **MKR FCTN**, see Chapter 11.

MEAS Key

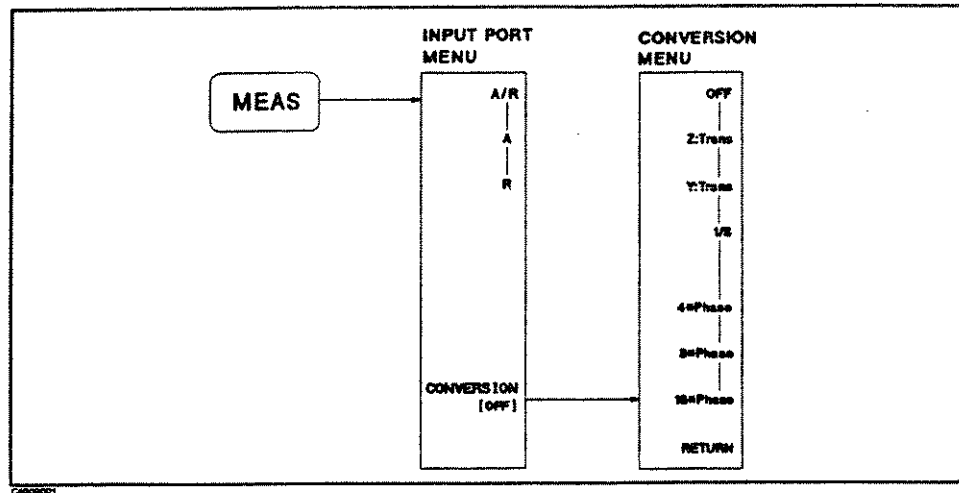

Figure 9-2. Softkey Menus Accessed from the **MEAS** Key

The HP-IB programming command is shown in parenthesis following the key or softkey.

The **MEAS** key leads to a series of softkey menus from which the parameters and measurement inputs are specified.

- Alternatively, the power ratio of two inputs (A/R) or the absolute power at either input can be measured and the results displayed.
- Using the HP 87510A's internal math capabilities, transmission characteristics can be converted to impedance (Z), admittance (Y), or inverse data (R/A, 1/A, and 1/R).
- The math capabilities allow multiplying phase data by a factor of 4, 8, or 16.

Input Ports Menu

The input ports menu is presented when the **MEAS** key is pressed if there is no S-parameter test set connected and two-port error correction is not ON. This menu defines the input ports for power ratio measurements, or a single input for magnitude only measurements of absolute power.

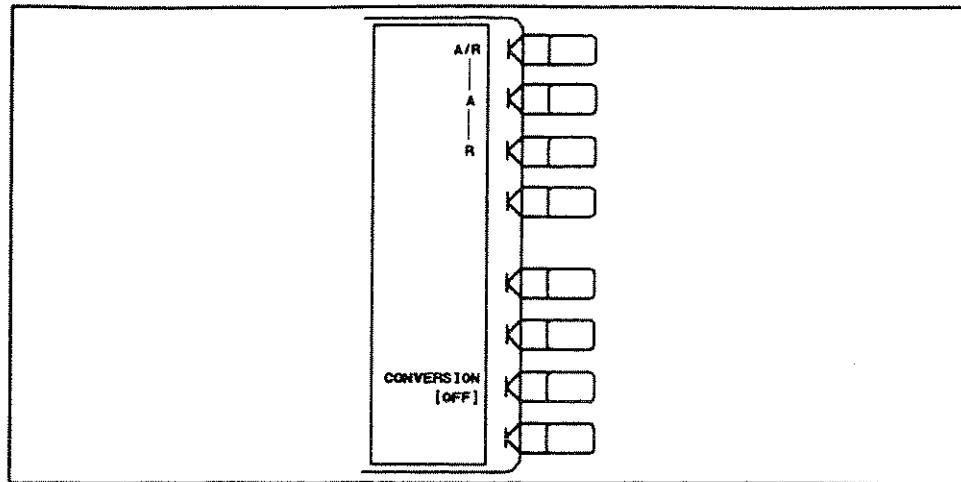

Figure 9-3. Input Ports Menu

A/R (AR) calculates and displays the complex ratio of the signal at input A to the reference signal at input R.

A (MEASA) measures the absolute power amplitude at input A.

R (MEASR) measures the absolute power amplitude at input R.

CONVERSION presents the conversion menu, which converts the measured data to impedance (Z) admittance (Y) or inverse data (R/A, 1/A, and 1/R). When a conversion parameter has been defined, it is shown in brackets under the softkey label. If no conversion has been defined, the softkey label reads **CONVERSION OFF**.

Conversion Menu

This menu converts the measured transmission data to the equivalent complex impedance (Z) or admittance (Y) values. This is not the same as a two-port Y or Z parameter conversion, as only the measured parameter is used in the following equations.

In a transmission measurement, the data can be converted to its equivalent series impedance or admittance using the model and equations shown in Figure 9-4.

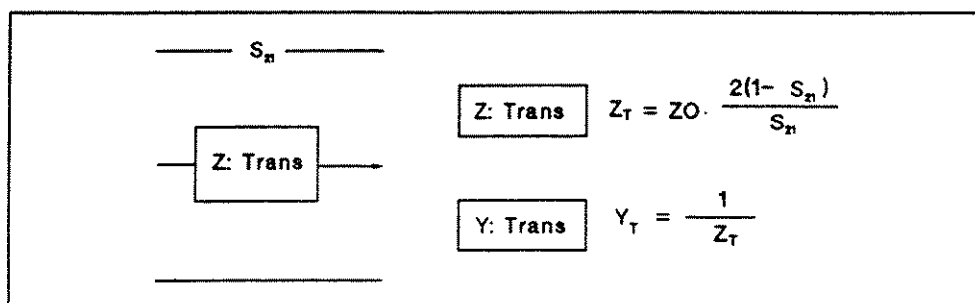

Figure 9-4. Transmission Impedance and Admittance Conversions

Avoid using delay formats for displaying Z and Y conversions, as these formats are not easily interpreted.

In Z and Y conversions, marker values are impedance values in Ω units for Z conversions, or admittance values in S units for Y conversions in any format.

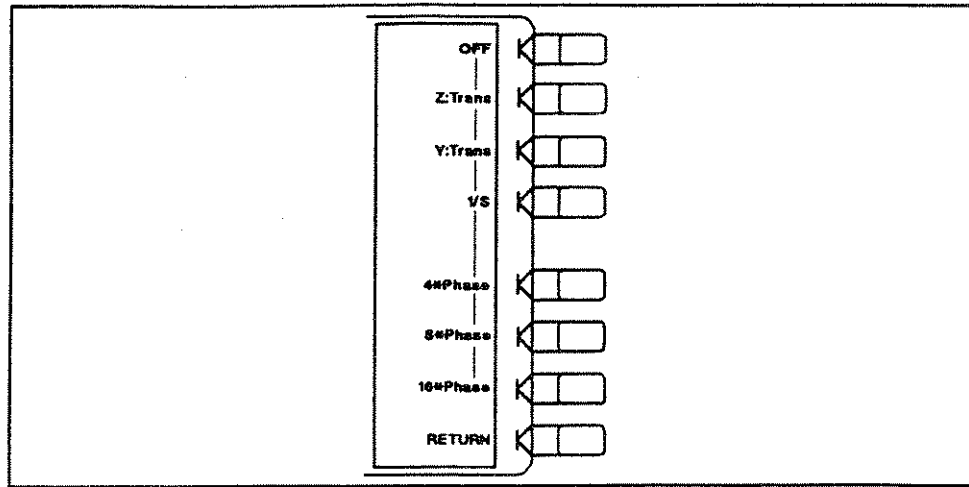

Figure 9-5. Conversion Menu

OFF (CONVOFF) turns OFF all parameter conversion operations.

Z: Trans (CONVZTRA) converts transmission data to its equivalent impedance values.

Y: Trans (CONVYTRA) converts transmission data to its equivalent admittance values.

1/S (CONV1DS) expresses the data in inverse S-parameter values, for use in amplifier and oscillator design.

4*phase (CONVMP4) multiplies phase data by a factor of 4.

8*phase (CONVMP8) multiplies phase data by a factor of 8.

16*phase (CONVMP16) multiplies phase data by a factor of 16.

RETURN returns to the input ports menu.

FORMAT Key

The HP-IB programming command is shown in parenthesis following the key or softkey.

Format Menu

The **FORMAT** key presents a menu used to select the appropriate display format for the measured data. Various rectangular and polar formats are available for display of magnitude, phase, real data, imaginary data, and group delay. The units of measurement are changed automatically to correspond with the displayed format. Special marker menus are available for the polar format, each providing several different marker types for readout of values (see Chapter 11).

The illustrations below show a reflection measurement of a bandpass filter displayed in each of the available formats.

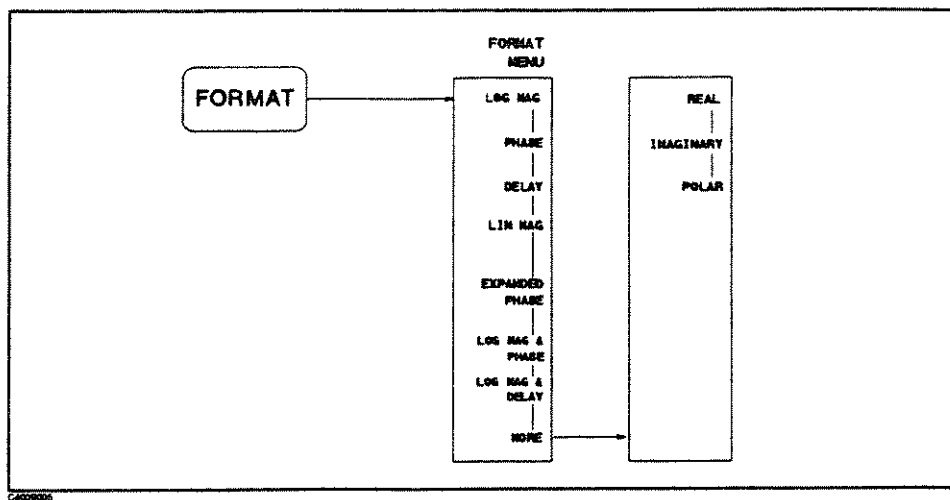

Figure 9-6. Format and Format More Menus

LOG MAG (LOGM) displays the log magnitude format. This is the standard Cartesian format used to display magnitude-only measurements of insertion loss, or absolute power in dB versus frequency. Figure 9-7 illustrates the bandpass filter transmission data in a log magnitude format.

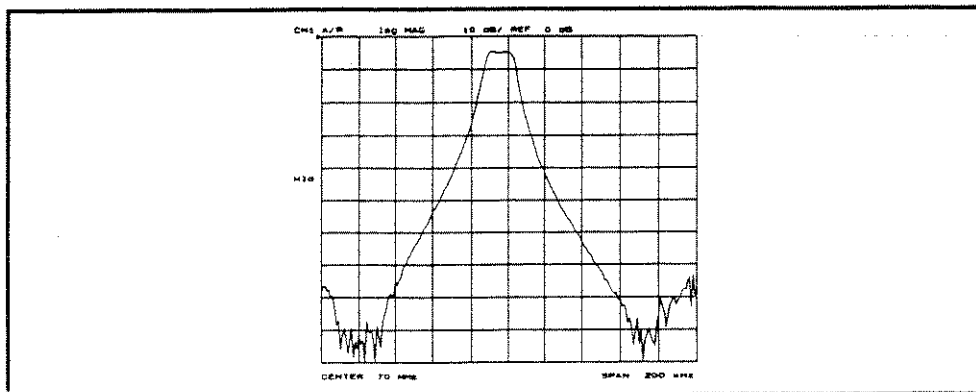

Figure 9-7. Log Magnitude Format

PHASE (PHAS) displays a Cartesian format of the phase portion of the data, measured in degrees. This format displays the phase shift versus frequency. Figure 9-8 illustrates the phase response of the same filter in a phase-only format.

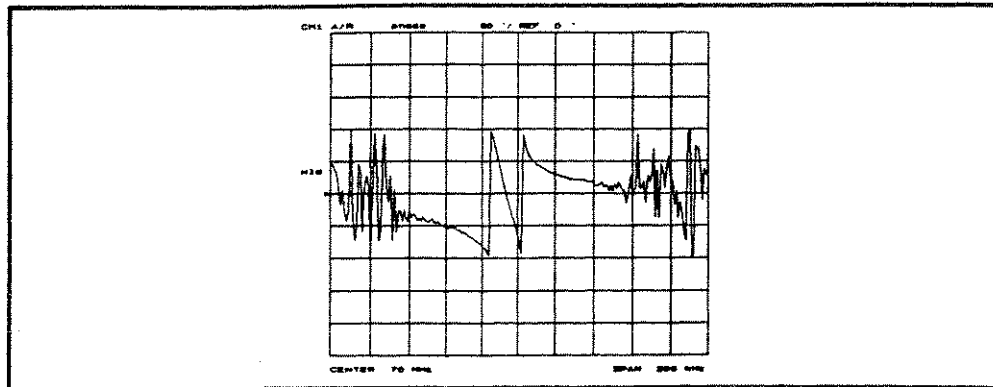

Figure 9-8. Phase Format

DELAY (DELA) selects the group delay format. Activated markers give values in seconds. Figure 9-9 shows the bandpass filter response formatted as group delay. When power sweep is selected, this selects the delay format using delta power instead of frequency. Group delay principles are described in the next few pages.

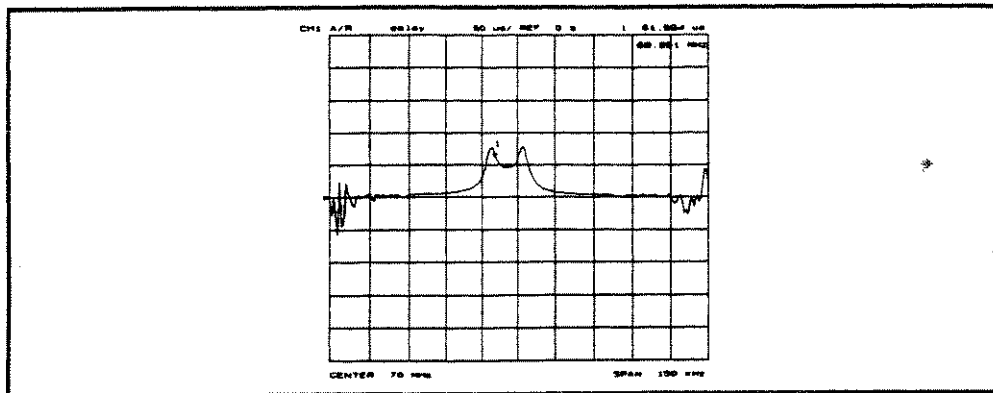

Figure 9-9. Group Delay Format

LIN MAG (LINM) displays the linear magnitude format (Figure 9-10). This is a Cartesian format used for unitless measurements such as reflection coefficient magnitude ρ or transmission coefficient magnitude τ , and for linear measurement units. It is used for display of conversion parameters.

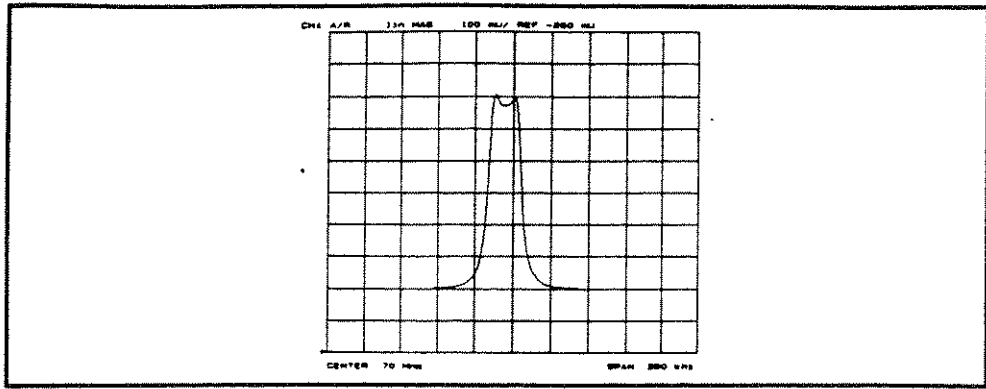

Figure 9-10. Linear Magnitude Format

EXPANDED PHASE (EXPP) displays the phase plot over 360°(Figure 9-11). When this is turned ON, the analyzer avoids the phase plot wrap around every 360°.

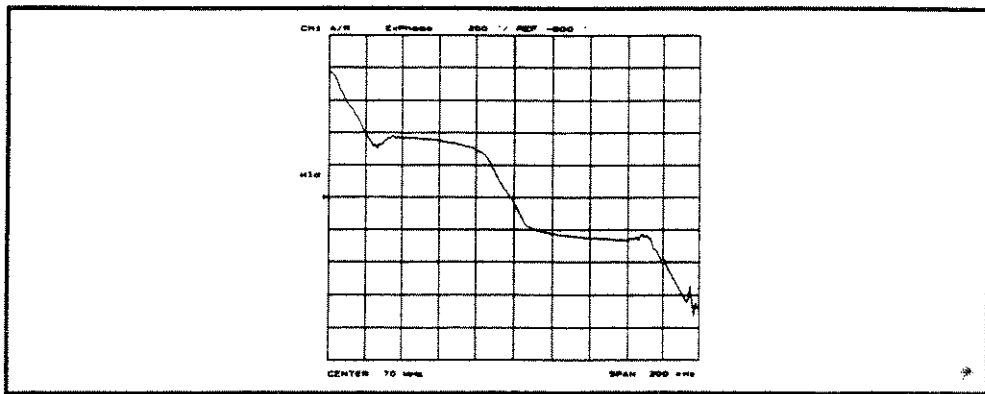

Figure 9-11. Expanded phase Format

LOG MAG & PHASE (LOGMP) displays log magnitude trace and phase trace for the active channel simultaneously. When this softkey is turned ON, some other softkeys will denote the log magnitude and the phase as "DATA" (data trace) and "SUB-TRACE" (sub trace), respectively.

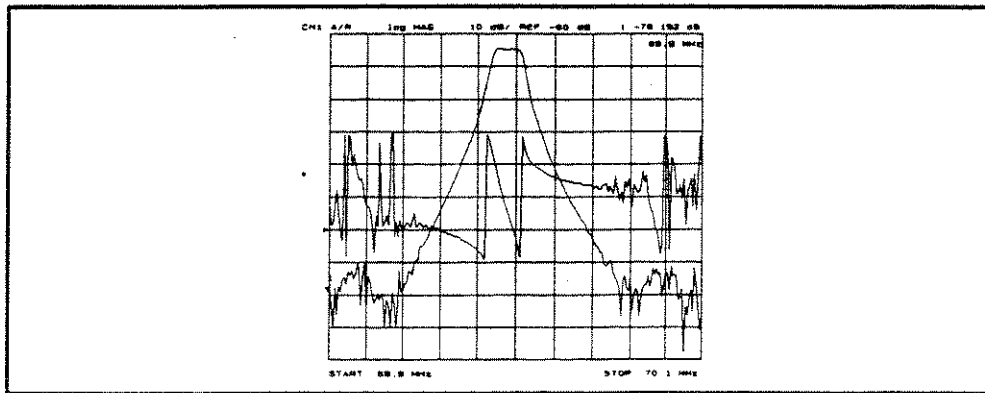

Figure 9-12. Log Magnitude and Phase Format

LOG MAG & DELAY (LOGMD) displays log magnitude trace and delay trace for the active channel simultaneously. When this softkey is turned ON, some other softkeys will denote the log magnitude trace and the delay as "DATA" (data trace) and "SUB" (sub trace), respectively.

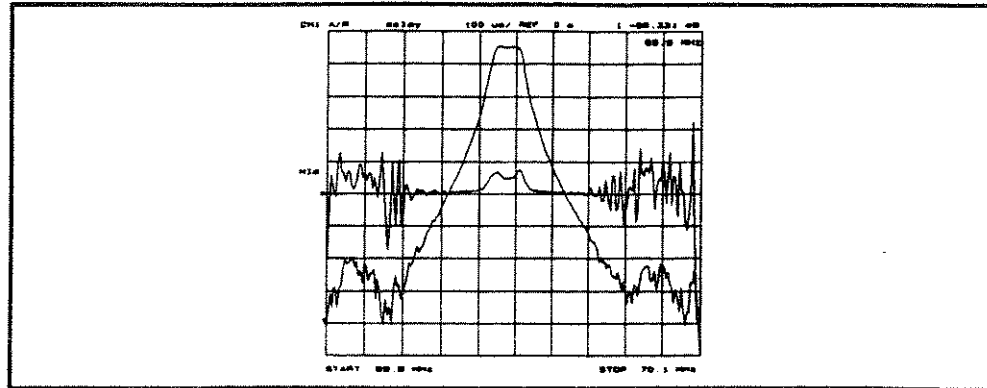

Figure 9-13. Log magnitude and Delay Format

MORE provides the format more menu described in the next section.

Format More Menu

This menu provides two additional formatting selections.

REAL (REAL) displays only the real (resistive) portion of the measurement data in Cartesian format (Figure 9-14). This is similar to the linear magnitude format, but can show both positive and negative values.

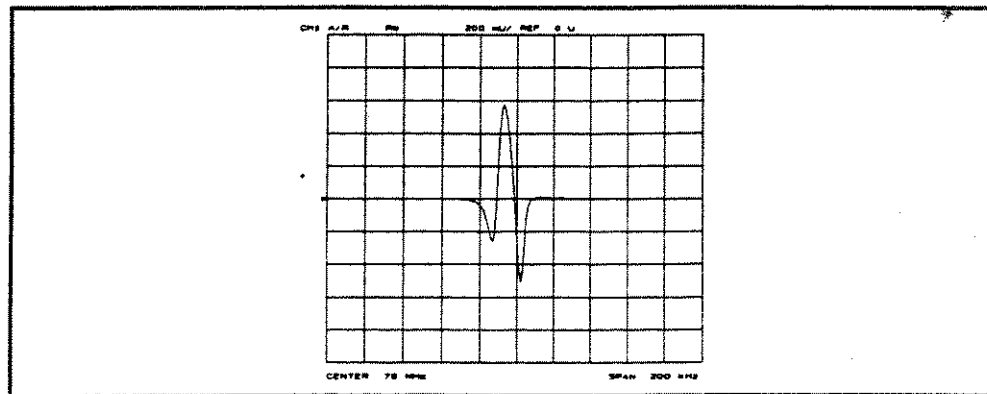

Figure 9-14. Real Format

IMAGINARY (IMAG) displays only the imaginary (reactive) portion of the measurement data in Cartesian format. This format is similar to the real format except that reactance data is displayed on the trace instead of impedance data.

POLAR (POLA) displays a polar format (Figure 9-15). Each point on the polar format corresponds to a particular value of both magnitude and phase. Quantities are read vectorally: the magnitude at any point is determined by its displacement from the center (which has zero value), and the phase by the angle counterclockwise from the positive x-axis. Magnitude is scaled in a linear fashion, with the value of the outer circle usually set to a ratio value of 1. Since there is no frequency axis, frequency information is read from the markers.

The default marker readout for the polar format is in linear magnitude and phase. A log magnitude marker and a real/imaginary marker are available in the polar marker menu (see Chapter 11).

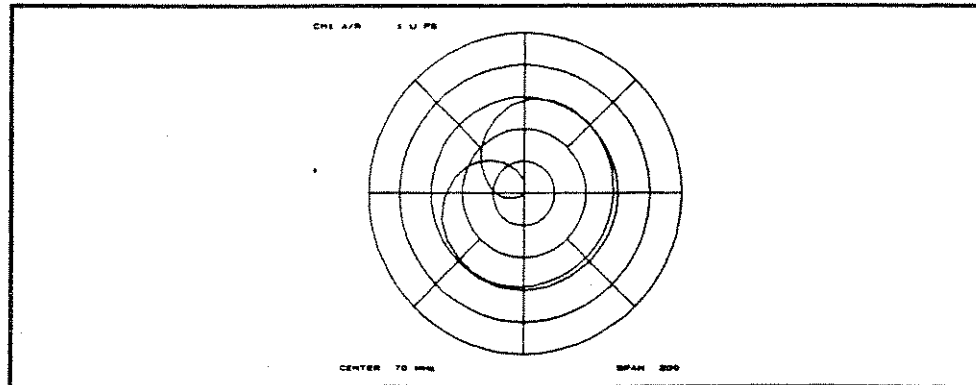

Figure 9-15. Polar Format

RETURN goes back to the format menu.

Group Delay Principles

For many gain and phase measurements, the amount of insertion phase is not as important as the linearity of the phase shift over a range of frequencies.

The analyzer can measure this linearity and express it in two different ways: directly, as deviation from linear phase, or as group delay, a derived value. See **SCALE REF** key description in this chapter for information on deviation from linear phase.

Group delay is the measurement of signal transmission time through a test device. It is defined as the derivative of the phase characteristic with respect to frequency. Since the derivative is basically the instantaneous slope (or rate of change of phase with frequency), a perfectly linear phase shift results in a constant slope, and therefore a constant group delay (Figure 9-16).

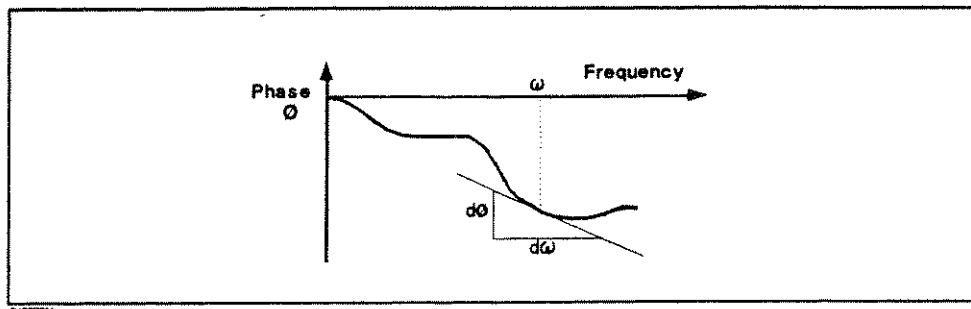

Figure 9-16. Constant Group Delay

Note, however, that the phase characteristic typically consists of both linear (first order) and higher order (deviations from linear) components. The linear component can be attributed to the electrical length of the test device, and represents the average signal transit time. The

higher order components are interpreted as variations in transit time for different frequencies, and represent a source of signal distortion (Figure 9-17).

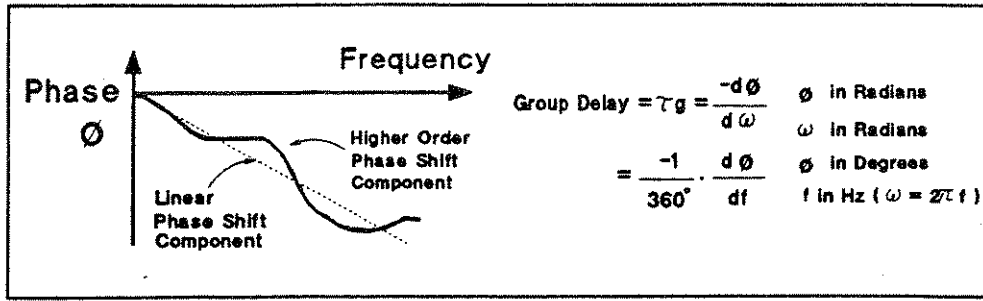

Figure 9-17. Higher Order Phase Shift

The analyzer computes group delay from the phase slope. Phase data is used to find the phase deviation, $\Delta\phi$, at the center point of a specified frequency aperture, Δf , to obtain an approximation for the rate of change of phase with frequency (Figure 9-18). This value, τ_g , represents the group delay in seconds assuming linear phase change over Δf .

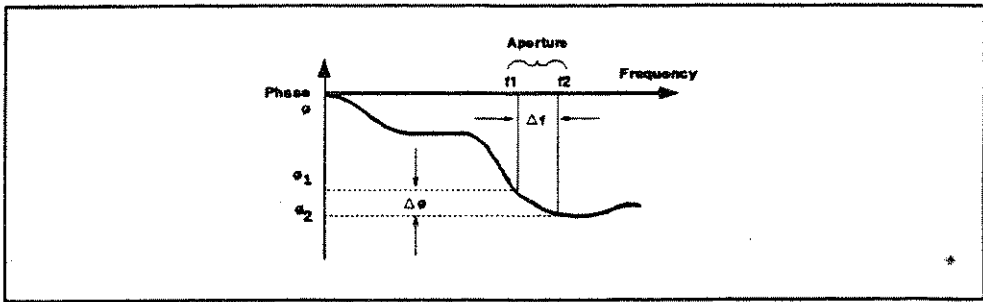

Figure 9-18. Rate of Phase Change Versus Frequency

When deviations from linear phase are present, changing the frequency step can result in different values for group delay. Note that in this case the computed slope varies as the aperture Δf is increased (Figure 9-19). A wider aperture results in loss of the fine variations in group delay. This loss of detail is the reason that in any comparison of group delay data it is important to know the aperture used to make the measurement.

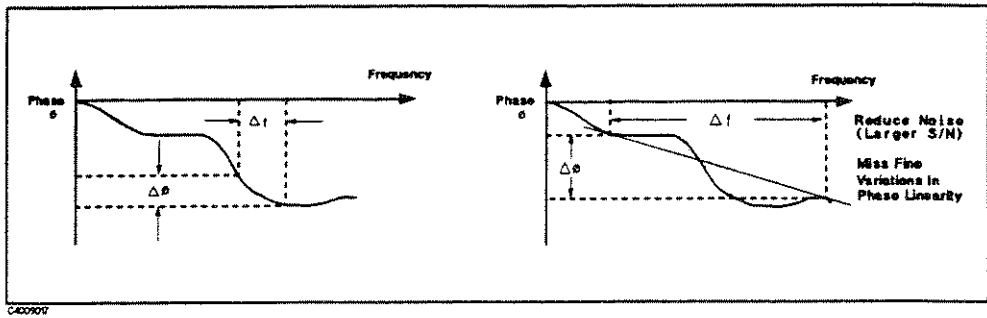

Figure 9-19. Variations in Frequency Aperture

In determining the group delay aperture, there is a tradeoff between resolution of fine detail and the effects of noise. Noise can be reduced by increasing the aperture, but this will tend to smooth out the fine detail. More detail will become visible as the aperture is decreased, but the noise will also increase, possibly to the point of obscuring the detail. A good practice is to use a smaller aperture to assure that small variations are not missed, then increase the aperture to smooth the trace.

The group delay aperture value will be a percent of the stimulus span swept which is based on the number of points. For example, the default value of 1% means that a group delay at a certain point is calculated using adjacent measurement points on both sides, if the number of points is 201.

Group delay measurements can be made on all sweep types. Group delay aperture varies depending on the frequency spacing and point density, therefore the aperture is not constant in log and list frequency sweep modes.

To obtain a readout of aperture values at different points on the trace, move the marker to a desired point. Then press **(AVG) GROUP DELY APERTURE**. Group delay aperture becomes the active function, and as the aperture is varied its value in Hz is displayed below the active entry area.

(SCALE REF) Key

The HP-IB programming command is shown in parenthesis following the key or softkey.

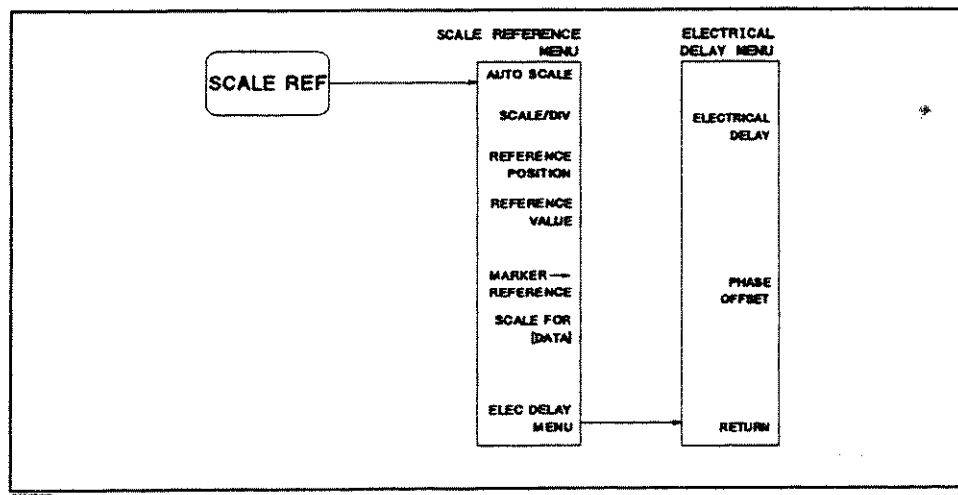

Figure 9-20. Softkey Menus Accessed from the **(SCALE REF) Key**

Scale Reference Menu

The **(SCALE REF)** key makes scale per division the active function. A menu is displayed that modifies the vertical axis scale and the reference line value and position. In addition this menu provides phase offset capabilities for adding or subtracting a phase offset, that is constant with frequency, and electrical delay capability for adding or subtracting linear phase to maintain phase linearity.

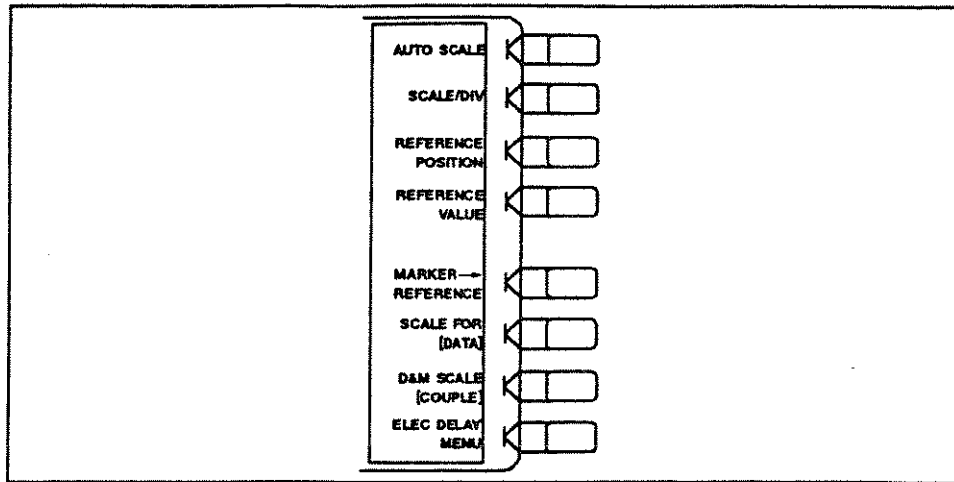

Figure 9-21. Scale Reference Menu

AUTO SCALE (AUTO) brings the trace data, defined by the **SCALE FOR** key, in view on the display with a single keystroke. Stimulus values are not affected, only the scale and reference values. The analyzer determines the smallest possible scale factor that will put all displayed data onto the vertical graticule. The reference value is chosen to put the trace in the center of the screen, then rounded to an integer multiple of 1-2-5 steps of the scale factor.

SCALE/DIV (SCAL) changes the response value scale per division of the displayed trace. In polar chart format, this refers to the full scale value at the outer circumference, and is identical to the reference value.

REFERENCE POSITION (REFP) sets the position of the reference line on the graticule of a Cartesian display, with 0 at the bottom line of the graticule and 10 at the top line. It has no effect on a polar display. The reference position is indicated with a small triangle just outside the graticule, on the left.

REFERENCE VALUE (REFV) changes the value of the reference line, moving the measurement trace correspondingly. In polar chart format, the reference value is the same as the scale, and is the value of the outer circle.

MARKER → REFERENCE (MARKREF) makes the reference value equal to the active marker's absolute value (regardless of the delta marker value). The marker is effectively moved to the reference line position. This softkey also appears in the marker function menu accessed from the **(MKR FCTN)** key. In polar chart format, this function makes the full scale value at the outer circle equal to the active marker response value.

SCALE FOR (SCAFDATA for the data trace, SCAFMEMO for the sub trace) selects one of "DATA" and "SUB" traces to be scaled by prior functions in this menu when the format is selected "LOG MAG & PHASE" and "LOG MAG & DELAY". When "LOG MAG & PHASE" format is selected, **SCALE FOR** selects one of "LOG MAG" and "PHASE" to be scaled. When "LOG MAG & DELAY" format is selected, **SCALE FOR** selects one of "LOG MAG" and "DELAY" to be scaled.

The "LOG MAG & PHASE" and "LOG MAG & DELAY" format will be available using the "Format More menu" accessed from the **(FORMAT)** key.

ELEC DELAY MENU provides "Electrical Delay Menu", which adds or subtracts a linear phase slope relative to frequency or a constant phase.

Electrical Delay Menu

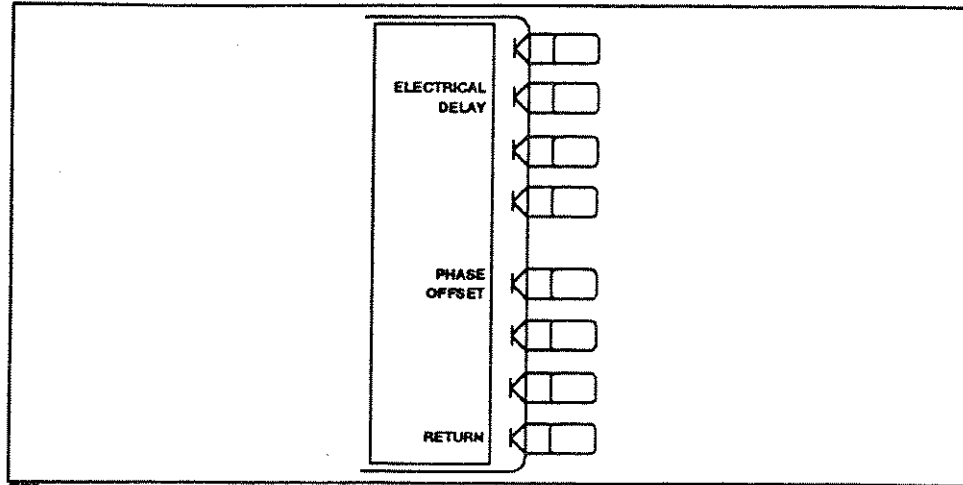

Figure 9-22. Electrical Delay Menu

ELECTRICAL DELAY (ELED) adjusts the electrical delay to balance the phase shift of the DUT. It simulates a variable length lossless transmission line, which can be added to or removed from a receiver input to compensate for interconnecting cables, etc. This function is similar to the mechanical or analog “line stretchers” of other analyzers. Delay is annotated in units of time with secondary labeling in distance for the current velocity factor.

With this feature, and with **MARKER → DELAY**, an equivalent length of air is added or subtracted according to the following formula:

$$\text{Length (meters)} = \frac{\phi}{\text{Frequency (MHz)} \times 1.20083}$$

Once the linear portion of the DUT's phase has been removed, the equivalent length of air can be read out in the active entry area. If the average relative permittivity (ϵ_r) of the DUT is known over the frequency span, the length calculation can be adjusted to indicate the actual length of the DUT more closely. This can be done by entering the relative velocity factor for the DUT using the calibrate more menu. The relative velocity factor for a given dielectric can be calculated by:

$$\text{Velocity factor} = \frac{1}{\sqrt{\epsilon_r}}$$

assuming a relative permeability of 1.

PHASE OFFSET (PHAO) adds or subtracts a phase offset that is constant with frequency (rather than linear). The allowable range is -360° to $+360^\circ$. This is independent of **MARKER → DELAY** and **ELECTRICAL DELAY**.

RETURN goes back to the scale reference menu.

DISPLAY Key

The HP-IB programming command is shown in parenthesis following the key or softkey.

The **DISPLAY** key provides access to dual channel display, active channel display title, frequency blanking, trace display ON/OFF, and graticule display ON/OFF.

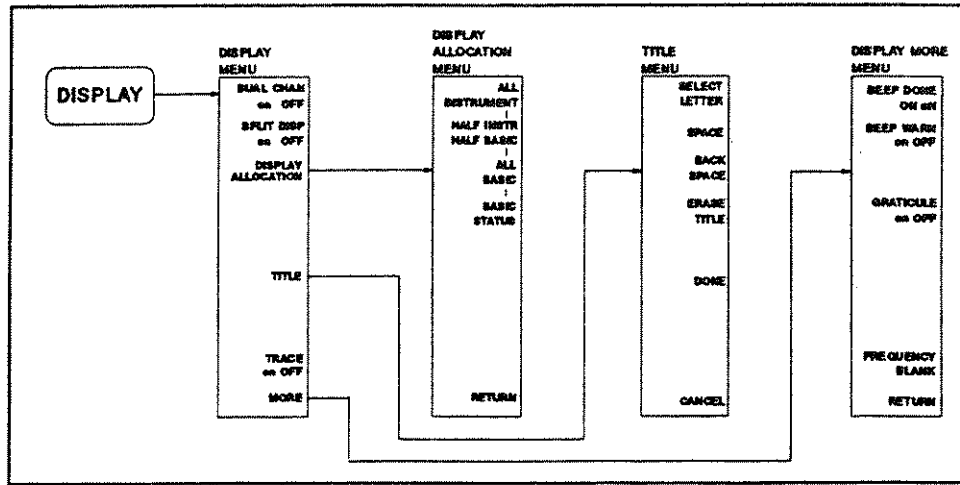

Figure 9-23. Softkey Menus Accessed from the **DISPLAY** Key

Display Menu

This menu provides the capability of displaying both channels simultaneously, either overlaid or split.

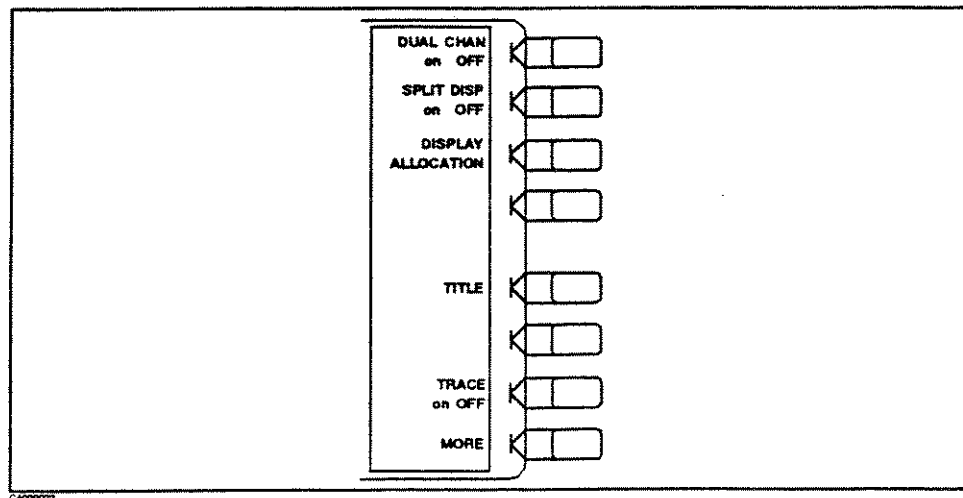

Figure 9-24. Display Menu

DUAL CHAN on OFF (DUACON, DUACOFF) toggles between display of both measurement channels or the active channel only. This is used in conjunction with **SPLIT DISP ON off** to display both channels.

SPLIT DISP on OFF (SPLDON, SPLDOFF) toggles between a full-screen single graticule display of one or both channels, and a split display with two half-screen graticules one

above the other. Both displays are illustrated in Figure 9-25. The split display can be used in conjunction with **DUAL CHAN ON** to show the measured data of each channel simultaneously on separate graticules. In addition, the stimulus functions of the two channels can be controlled independently using **COUPLED CH OFF** in the stimulus menu. The markers can also be controlled independently for each channel using **MARKERS: UNCOUPLED** in the marker mode menu.

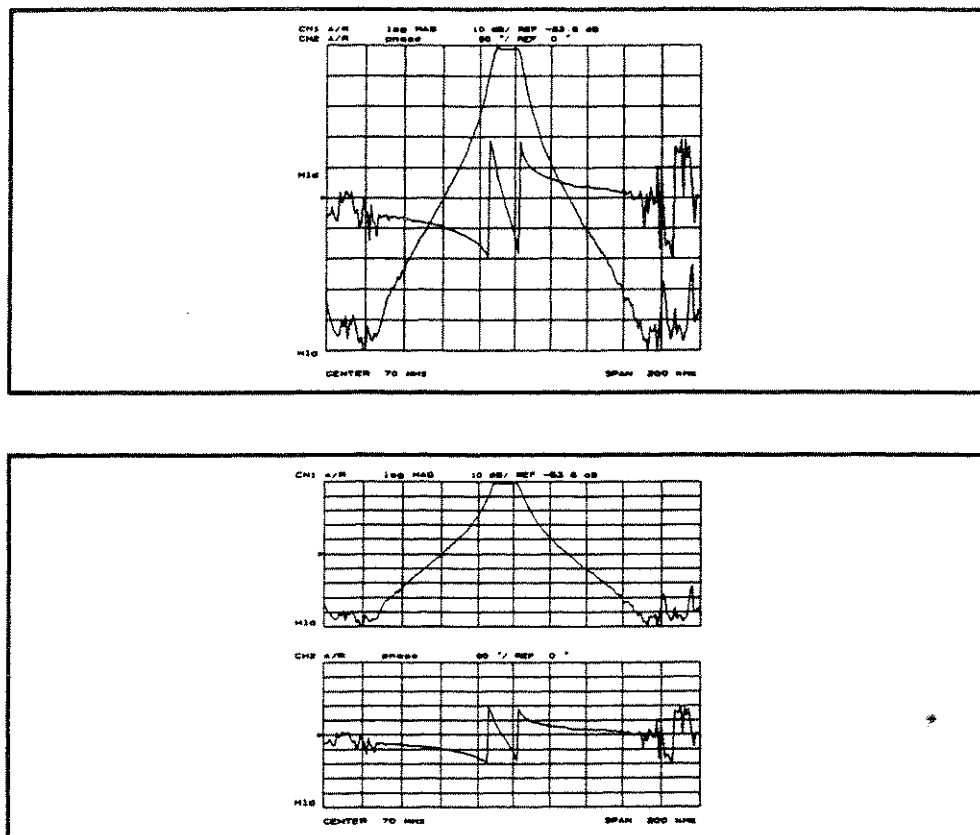

Figure 9-25. Full-screen and Split Display

DISPLAY ALLOCATION brings up the allocation menu which selects a full-screen display of measured data or the Instrument BASIC display, and a split display with two half-screens, one graticule display above the Instrument BASIC display.

TITLE (TITL) presents the title menu in the softkey labels area and the character set in the active entry area. These label the active channel display.

TRACE on OFF (TRADON, TRADOFF) toggles the trace display on the screen. This function does not affect the marker display. The markers are displayed on the screen even if the trace display is OFF. To erase markers, use **CLEAR MARKER** under the **(MKR)** key (See Chapter 11).

MORE leads to the display more menu.

Display More Menu

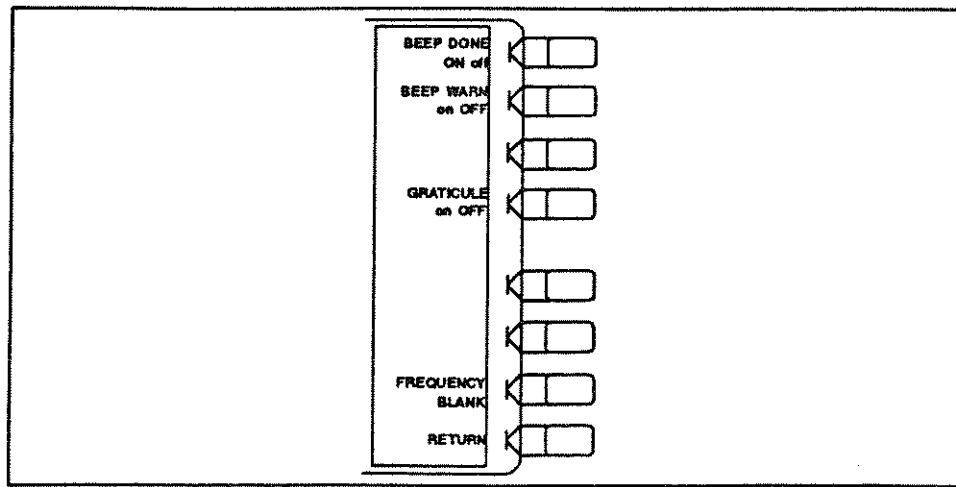

Figure 9-26. Display More Menu

BEEP DONE ON off (BEEPDONEON, BEEPDONEOFF) toggles an annunciator which sounds to indicate completion of certain operations such as calibration or instrument state save.

BEEP WARN on OFF (BEEPWARNON, BEEPWARNOFF) toggles the warning annunciator. When the annunciator is ON it sounds a warning when a cautionary message is displayed.

GRATICULE ON off (DISGON DISGOFF) toggles the graticule display on the screen. This function does not affect the trace display.

FREQUENCY BLANK (FREQ) blanks the displayed frequency notation for security purposes. Frequency labels cannot be restored except by instrument preset or turning the power OFF and then ON.

RETURN goes back to the display menu.

Display Allocation Menu

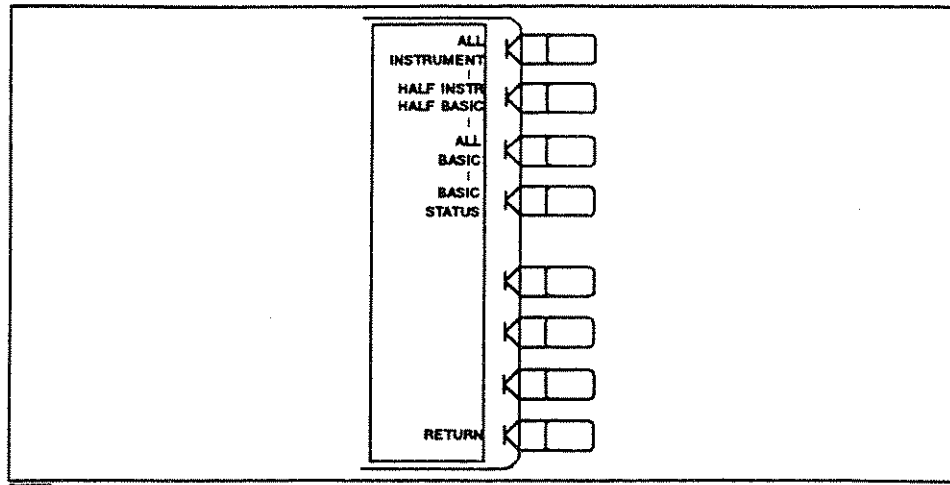

Figure 9-27. Display Allocation Menu

ALL INSTRUMENT (DISAALLI) selects a full screen single screen or two half-screen graticules.

HALF INSTR HALF BASIC (DISAHIHB) selects two half-screens, one graticule display above the Instrument BASIC display.

ALL BASIC (DISAALLB) selects a full screen single Instrument BASIC display.

BASIC STATUS (DISABASS) selects a full screen graticule and allocates three status lines for displaying status and entering commands of Instrument BASIC under the graticule.

RETURN goes back to the display menu.

Title Menu

Use this menu to specify a title for the active channel. The title identifies the display regardless of stimulus or response changes, and is printed or plotted with the data.

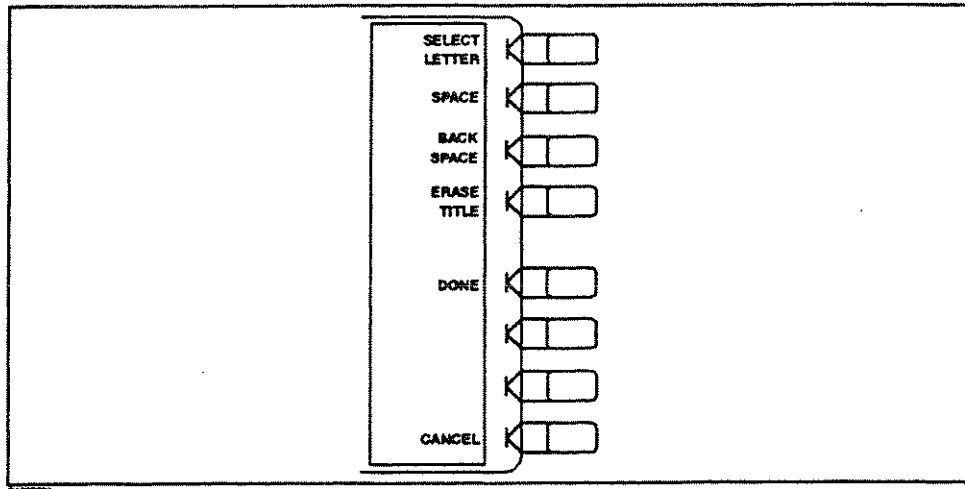

Figure 9-28. Title Menu

SELECT LETTER The active entry area displays the letters of the alphabet, digits 0 through 9, and some special characters including mathematical symbols. Three sets of letters can be scrolled using the step keys, \uparrow and \downarrow . To define a title, press step keys for the desired letter set, rotate the knob until the arrow " \uparrow " points at the first letter, then press **SELECT LETTER**. As each letter is selected, it is appended to the title at the top of the graticule. Repeat this until the complete title is defined, a maximum of 53 letters. It is also possible to input the letters from the keyboard provided with Instrument BASIC (Option 002).

SPACE inserts a space in the title.

BACK SPACE deletes the last character entered.

ERASE TITLE deletes the entire title.

DONE terminates the title entry, and returns to the display more menu.

CANCEL cancels the title entry and returns to the display more menu without any change.

AVG Key

The HP-IB programming command is shown in parenthesis following the key or softkey.

The **AVG** key accesses four different noise reduction techniques: sweep-to-sweep averaging, display smoothing, variable IF bandwidth, and group delay aperture for group delay measurement. Any or all of these can be used simultaneously. Averaging, smoothing and group delay aperture can be set independently for each channel, and the IF bandwidth can be set independently if the stimulus is uncoupled.

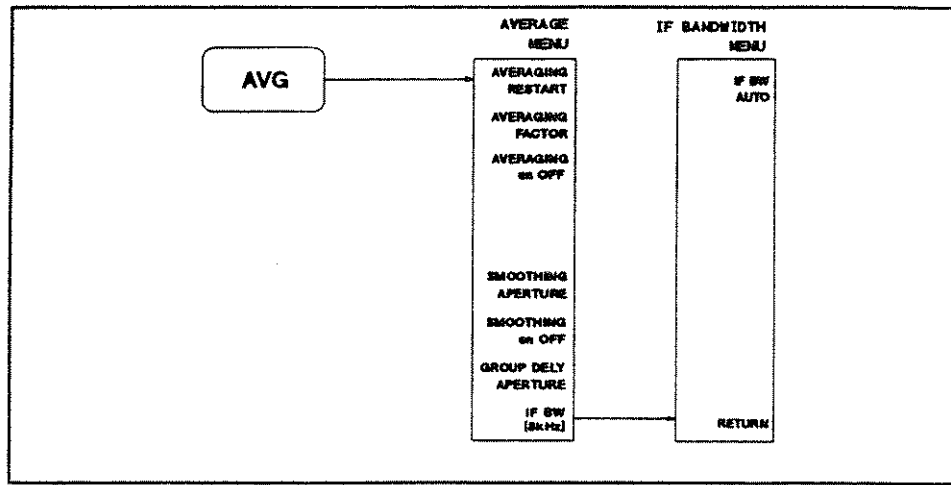

Figure 9-29. Softkey Menus Accessed from the **AVG** Key

Averaging

Averaging computes each data point based on an exponential average of consecutive sweeps weighted by a user-specified averaging factor. Each new sweep is averaged into the trace until the total number of sweeps is equal to the averaging factor, for a fully averaged trace. Each point on the trace is the vector sum of the current trace data and the data from the previous sweep. A high averaging factor gives the best signal-to-noise ratio, but slows the trace update time. Doubling the averaging factor reduces the noise by 3 dB. Figure 9-30 illustrates the effect of averaging on a log magnitude format trace.

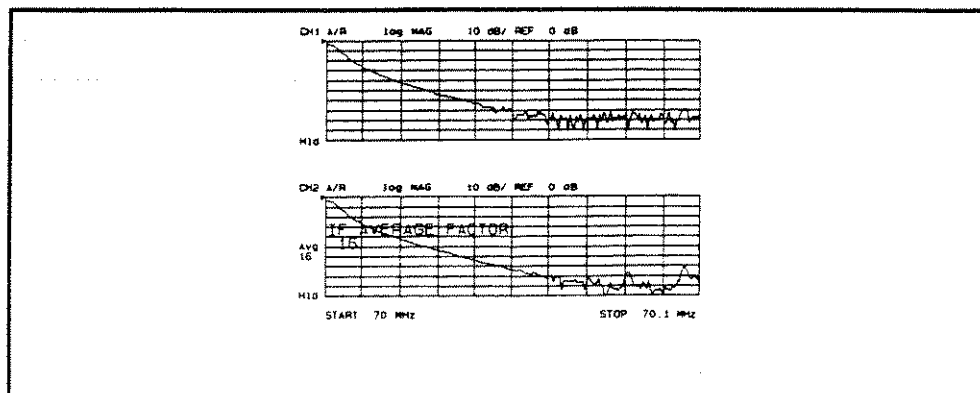

Figure 9-30. Effect of Averaging on a Trace

Smoothing

Smoothing (similar to video filtering) averages the formatted active channel data over a portion of the displayed trace. Smoothing computes each displayed data point based on one sweep only, using a moving average of several adjacent data points for the current sweep. The smoothing aperture is a percent of the stimulus span swept, up to a maximum of 100%.

Rather than lowering the noise floor, smoothing finds the mid-value of the data. Use it to reduce relatively small peak-to-peak noise values on broadband measured data. Use a sufficiently high number of display points to avoid misleading results. Do not use smoothing for measurements of high Q resonant devices or other devices with wide variations in the trace, as it will introduce errors into the measurement.

In polar display format, large phase shifts over the smoothing aperture will cause shifts in amplitude, since a vector average is being computed. Figure 9-31 illustrates the effect of smoothing on a log magnitude format trace.

If data and memory traces are displayed, smoothing is performed on both of them.

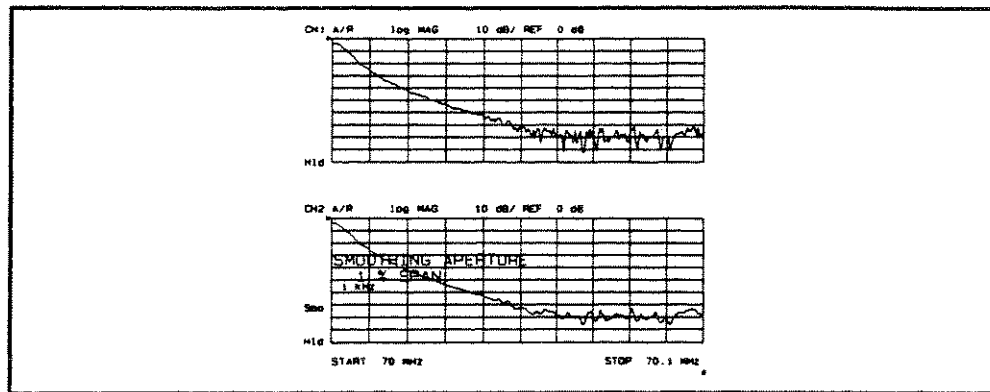

Figure 9-31. Effect of Smoothing on a Trace

IF Bandwidth Reduction

IF Bandwidth Reduction lowers the noise floor by reducing the receiver input bandwidth. It has an advantage over averaging in reliably filtering out unwanted responses such as spurs, odd harmonics, higher frequency spectral noise, and line-related noise. Sweep-to-sweep averaging, however, is better at filtering out very low frequency noise. A tenfold reduction in IF bandwidth (from 200 Hz to 20 Hz, for example) lowers the measurement noise floor by about 10 dB.

Another difference between sweep-to-sweep averaging and variable IF bandwidth is the sweep time. Averaging displays the first complete trace faster but takes several sweeps to reach a fully averaged trace. IF bandwidth reduction lowers the noise floor in one sweep, but the sweep time may be slower. Figure 9-32 illustrates the difference in noise floor between a trace measured with a 1 kHz IF bandwidth and with a 20 Hz IF bandwidth.

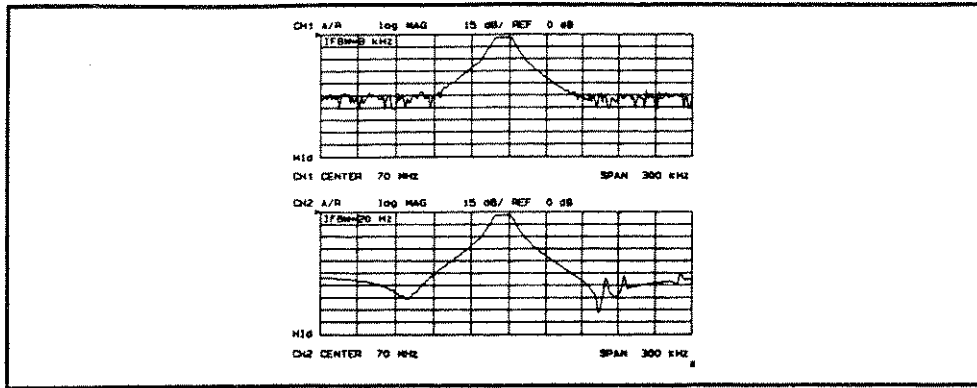

Figure 9-32. IF Bandwidth Reduction

Group Delay Aperture

Changing group delay aperture will lower the noise on the group delay trace. See Group Delay Principles earlier in this chapter.

Another capability that can be used for effective noise reduction is the marker statistics function, which computes the average value of part or all of the formatted trace. See Chapter 11.

Average Menu

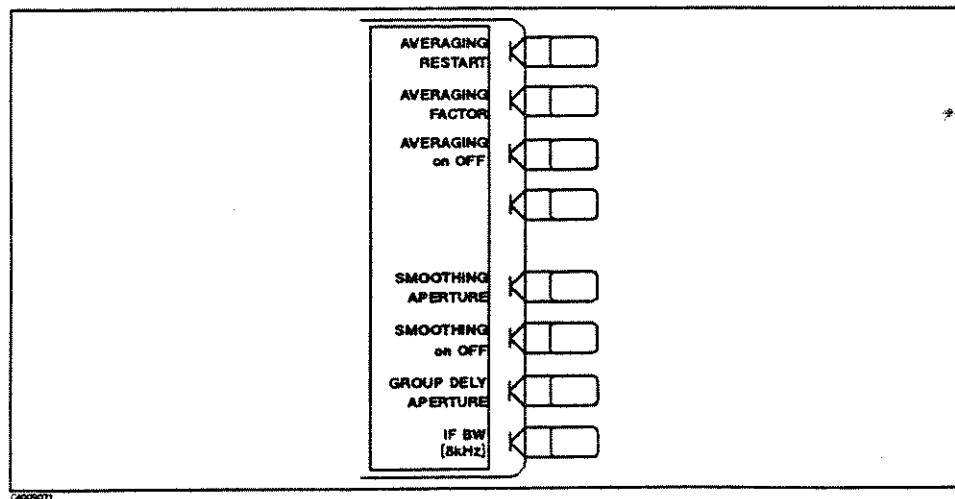

Figure 9-33. Average Menu

AVERAGING RESTART (AVERREST) resets the sweep-to-sweep averaging and restarts the sweep count at 1 at the beginning of the next sweep. The sweep count for averaging is displayed at the left of the display.

AVERAGING FACTOR (AVERFACT) makes averaging factor the active function. Any value up to 999 can be used. The algorithm used for averaging is:

$$A_{(n)} = \frac{S_{(n)}}{F} + \left(1 - \frac{1}{F}\right) \times A_{(n-1)}$$

where,

$A_{(n)}$ = current average

$S_{(n)}$ = current measurement

F = average factor

AVERAGING on OFF (AVERON, AVEROFF) turns the averaging function ON or OFF for the active channel. "Avg" is displayed in the status notations area at the left of the display, together with the sweep count for the averaging factor, when averaging is ON. The sweep count for averaging is reset to 1 whenever an instrument state change affecting the measured data is made.

At the start of averaging or following **AVERAGING RESTART**, averaging starts at 1 and averages each new sweep into the trace until it reaches the specified averaging factor. The sweep count is displayed in the status notations area below "Avg" and updated every sweep as it increments. When the specified averaging factor is reached, the trace data continues to be updated, weighted by that averaging factor.

SMOOTHING APERTURE (SMOOPER) lets you change the value of the smoothing aperture as a percent of the span. When smoothing aperture is the active function, its value in stimulus units is displayed below its percent value in the active entry area. The allowed range is 0.05 through 100 % of span and resolution is 0.001%.

SMOOTHING on OFF (SMOON, SMOOFF) turns the smoothing function ON or OFF for the active channel. When smoothing is ON, the annotation "Smo" is displayed in the status notations area. The algorithm used for smoothing is:

$$S_{m(n)} = \frac{D_{(n-m)} + \dots + D_{(n)} + \dots + D_{(n+m)}}{2m + 1}$$

where

$S_{m(n)}$ = smoothed data

$D_{(n)}$ = unsmoothed data

m : determined by smoothing aperture

GROUP DELAY APERTURE (GRODAPER) sets the aperture for group delay measurements as a percent of the span (see Group Delay Principles earlier in this chapter). A frequency aperture Δf at the active marker is displayed under the percent value when the format is DELAY.

IF BW (IFBW) selects the bandwidth value for IF bandwidth reduction. Allowed values (in Hz) are k, 4 k, 1 k, 200, and 20. Any other value will default to the closest allowed value. A narrow bandwidth slows the sweep speed but provides better signal-to-noise ratio. The selected bandwidth value is shown in brackets in the softkey label.

IF Bandwidth Menu

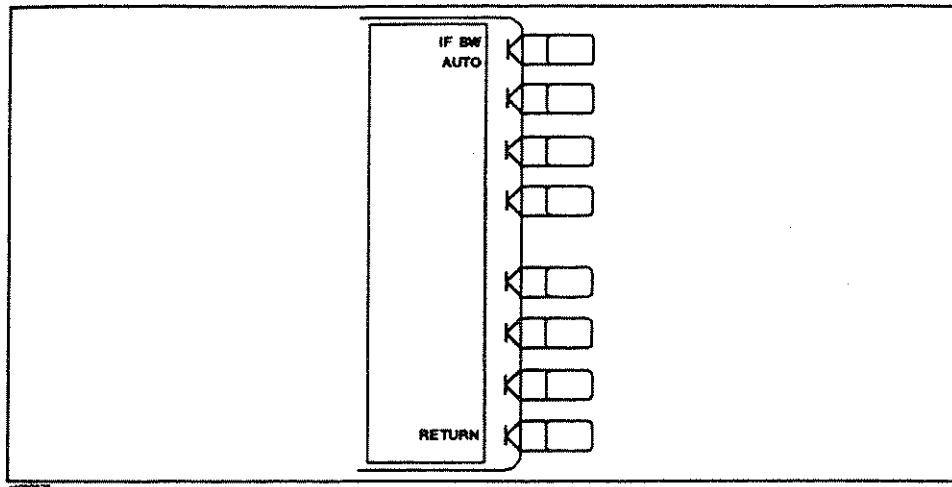

Figure 9-34. IF Bandwidth Menu

IF BW AUTO (IFBWAUTO) selects the proper IF bandwidth automatically for each measurement point while the measuring frequency is swept. This is convenient for getting fast and good performance when the log frequency sweep type is selected.

The best bandwidth depends on the measuring frequency. The relations between measuring frequency and IF bandwidth are as follows:

Table 9-1. IF Bandwidth in AUTO mode

Frequency	IF Bandwidth	*
1 kHz to 1.999 999 kHz	20 Hz	
2 kHz to 99.999 999 kHz	200 Hz	
100 kHz to 999.999 999 kHz	1 kHz	
1 MHz to 300 MHz	4 kHz	

RETURN goes back to the average menu.

SPCL FCTN Key

This key provides the special function menu, that quickly gets certain measurement parameters without going through the usual key sequence.

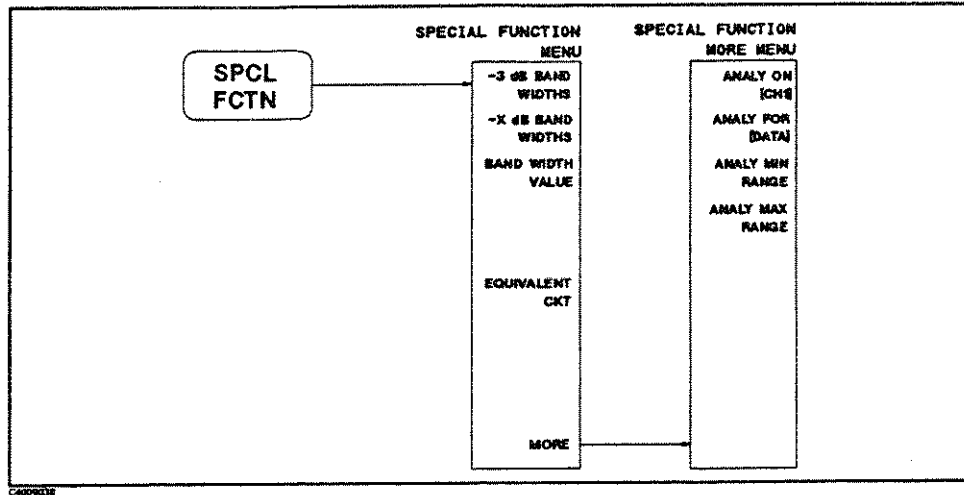

Figure 9-35. Softkey Menus Accessed from the SPCL FCTN Key

Special Function Menu

This menu has two functions, one derives filter parameters (for example, 3 dB bandwidth) and the other is statistical functions. These functions perform the same functions using the wave form analysis HP-IB commands. For more information on the wave form analysis commands, see Appendix E in the *HP-IB Programming Manual*.

Note These functions are independent of the marker function.

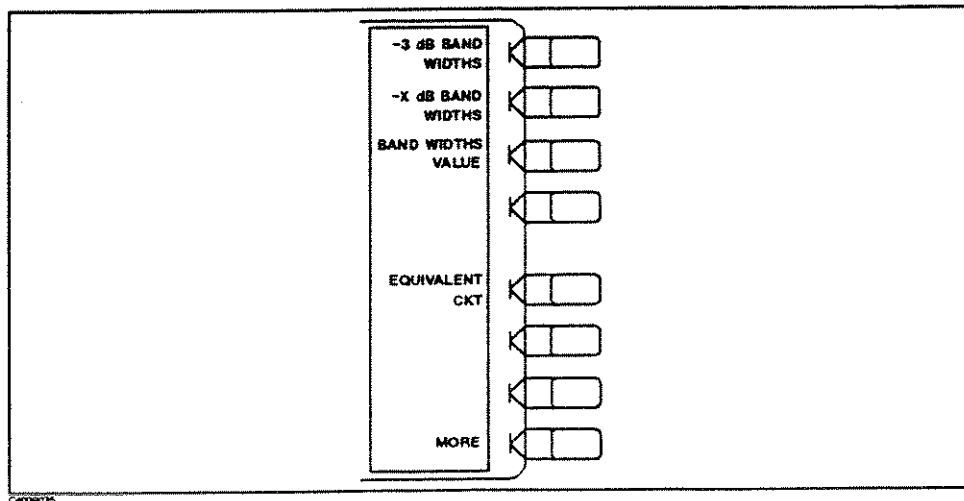

Figure 9-36. Special Function Menu

-3dB BAND WIDTH (OUTPFILT?) displays filter specific parameters, insertion loss, -3dB band width, frequency at the center point of two cutoff points (f_{cent}), Q , left cutoff point frequency (ΔLF), and right cutoff point frequency (ΔRF) within the range specified by **ANALY MIN** and **ANALY MAX**.

Figure 9-37 shows a typical example of a bandpass filter measurement trace. The insertion loss is the absolute value of the difference of the maximum within a specified range and 0 dB. BW is the stimulus width between two cutoff points (f_1 and f_2) and the center point of two cutoff points are given as f_{cent} . Q is calculated as:

$$Q = \frac{\sqrt{f_1 \times f_2}}{BW}$$

ΔLF is the stimulus difference between the left -3 dB cutoff point and the center point of a specified range. Similarly, ΔRF is the difference between the right cutoff point and the center of a specified range.

Zeros will be returned for all parameters when two -3 dB points can not be found.

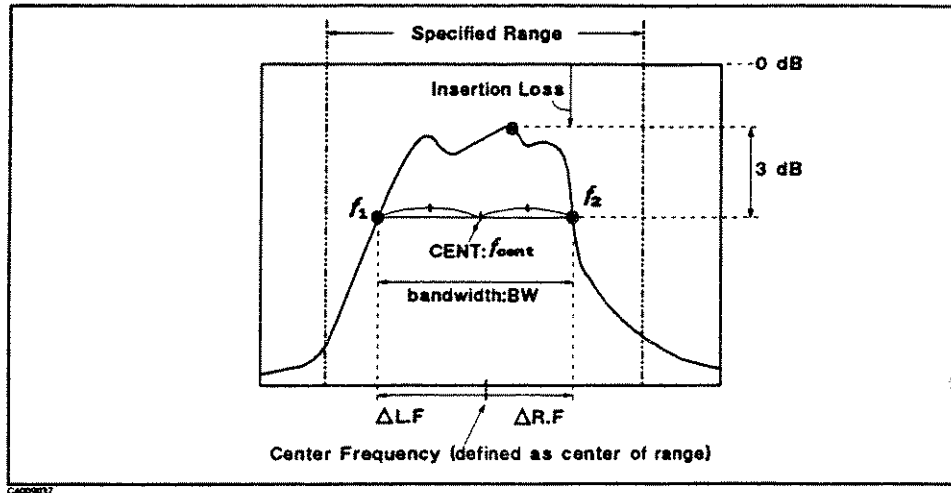

Figure 9-37. Output Filter Parameters Example

EQUIVALENT CKT (EQUCPARA?) derives four parameters for the equivalent circuit used for a crystal resonator, within the frequency range specified by **ANALY MIN** and **ANALY MAX**. The equivalent circuit is shown in Figure 9-38

Zeros will be returned for all parameters when if no parameters can be found.

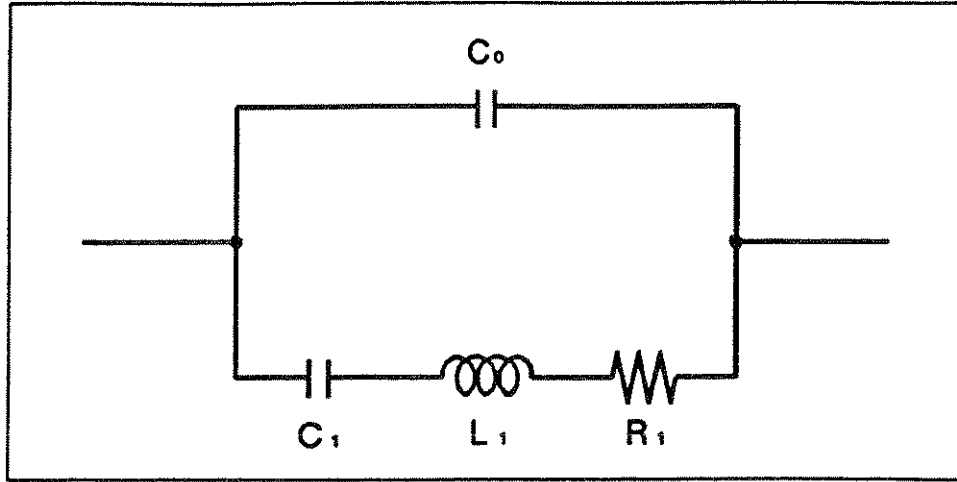

Figure 9-38. Four-Element Equivalent Circuit for Crystal Resonator

MORE provides the Special Function more menu described in the next section.

Special Function More Menu

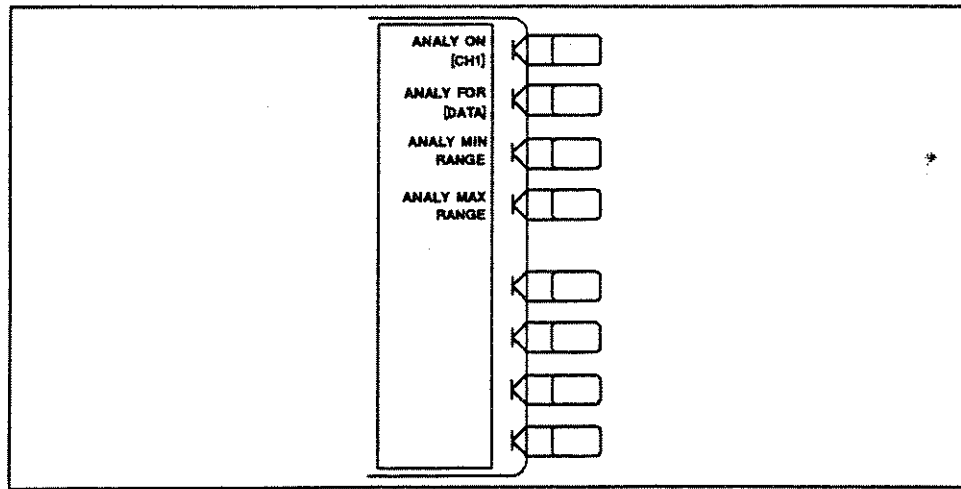

Figure 9-39. Special Function More Menu

ANALY ON [] (ANA0CH1, ANA0CH2) selects the channel to be used by the special functions.

[CH1] selects channel 1 and **[CH2]** selects channel 2. The channel selected is independent of the active channel.

ANALY FOR [] (ANA0DATA, ANA0MEMO) selects the object trace to be used by the special functions. **[DATA]** selects a data trace and **[SUB]** selects a sub trace for special functions.

Note

The target trace (DATA OR SUB) can be specified independently for each channel. The **ANALY ON** softkey is effective for the currently selected channel. So, **ANALY FOR** should be set after switching channels using **ANALY ON**.

ANALY MIN RANGE (ANARANG) sets the minimum frequency of the stimulus range (analysis range) for the special functions. The default setting for the analysis range is equal to the full stimulus range being set.

ANALY MAX RANGE (ANARANG) sets the maximum frequency of the stimulus range (analysis range) for the special functions. The default setting for the analysis range is equal to the full stimulus range being set.

RETURN returns to the input ports menu.

Note

ANALY MIN RANGE and **ANALY MAX RANGE** are specified independently from the marker search range.

When the analysis range exceeds the stimulus range being set, the analysis range is reset to match the stimulus range.

If the stimulus setting is modified after the analysis range is set, the HP 87510A resets the analysis range to the full range of the new stimulus range.

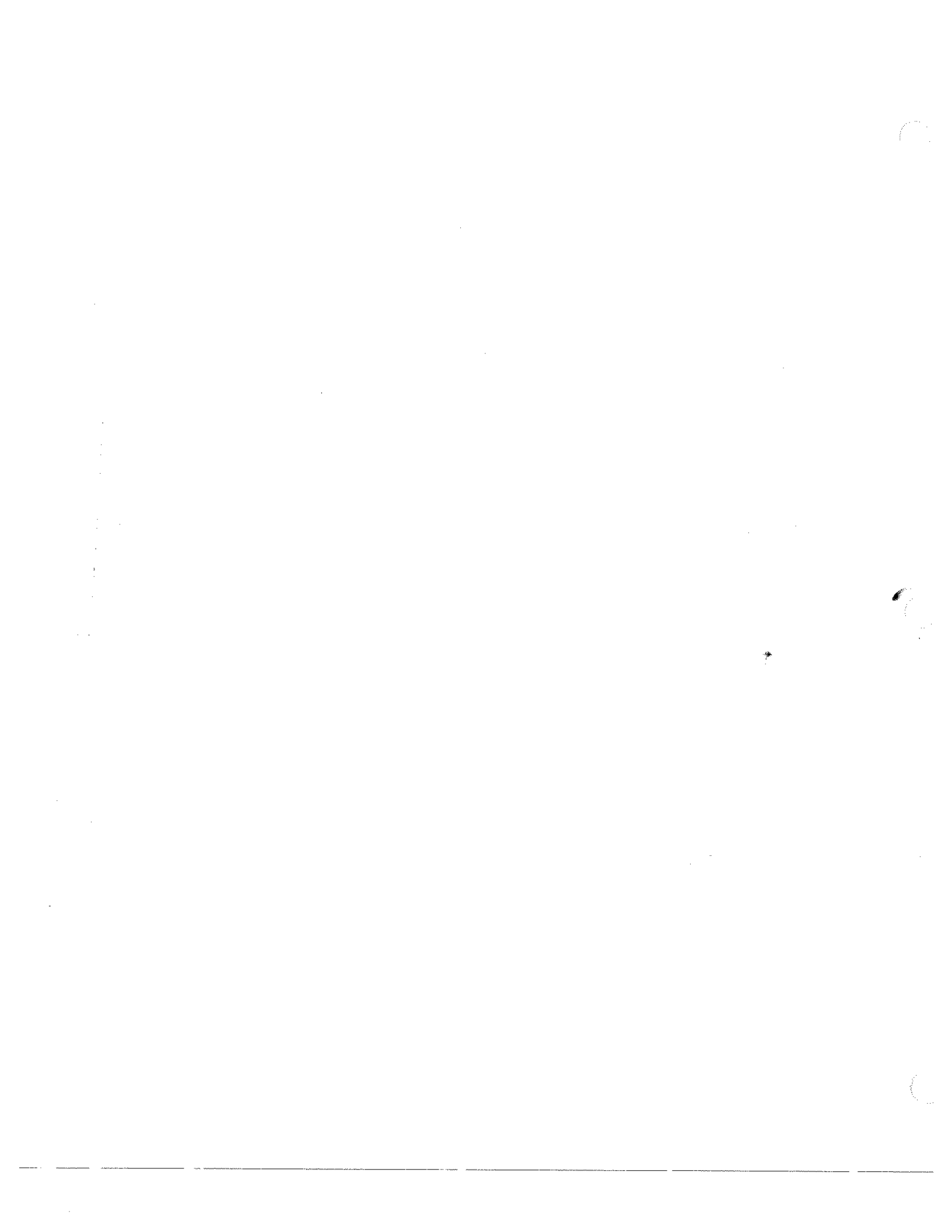

Measurement Calibration

Introduction

Measurement calibration is an accuracy enhancement procedure that effectively reduces the system errors that cause uncertainty when making a measurement (DUT). Known standard devices are measured, and the results of these measurements are used to characterize the system.

This chapter explains the theoretical fundamentals of accuracy enhancement and the sources of measurement errors. It describes the different measurement calibration procedures available in the analyzer, which errors they correct, and the measurements for which each should be used.

Accuracy Enhancement

If it were possible for a perfect measurement system to exist, it would have infinite dynamic range, isolation, and directivity characteristics, no impedance mismatches in any part of the test setup, and flat frequency response. Vector accuracy enhancement, also known as measurement calibration or error correction, provides the means to simulate a perfect measurement system.

In any high frequency measurement, there are measurement errors associated with the system that contribute uncertainty to the results. Parts of the measurement setup such as interconnecting cables and signal separation devices (as well as the analyzer itself) all introduce variations in magnitude and phase that can mask the actual performance of the device under test.

For example, crosstalk due to the channel isolation characteristics of the analyzer can contribute an error equal to the transmission signal of a high-loss test device. The measurement system cannot distinguish the true value of the signal reflected by the device under test from the signal arriving at the receiver input due to leakage in the system. For transmission measurements, impedance mismatches within the test setup cause measurement uncertainties that appear as ripples superimposed on the measured data.

Measurement calibration simulates a perfect analyzer system. It measures the magnitude and phase responses of known standard devices, and compares the measurement with actual device data. It uses the results to characterize the system and effectively remove the system errors from the measurement data of a test device, using vector math capabilities internal to the analyzer.

When measurement calibration is used, the dynamic range and accuracy of the measurement are limited only by system noise and stability, connector repeatability, and the accuracy to which the characteristics of the calibration standards are known.

Correcting for Measurement Errors

The analyzer has three different measurement calibration routines to characterize one or more of the systematic error terms and remove their effects from the measured data.

The **Response Calibration** effectively reduces the frequency response errors of the test setup for reflection or transmission measurements. This calibration procedure may be adequate for measurement of well matched low-loss devices.

The **Response and Isolation Calibration** effectively removes frequency response and crosstalk errors in transmission measurements. This procedure may be adequate for measurement of well matched high-loss devices.

The **3 term calibration** procedures provide the same correction measurements as the S_{11} 1-port calibration of conventional network analyzers. This calibration also applies to error correction for the π network measurement to test crystal resonators.

All the calibration procedures described above are accessed from the **CAL** key and are described in the following pages.

Menus and Softkeys

CAL Key

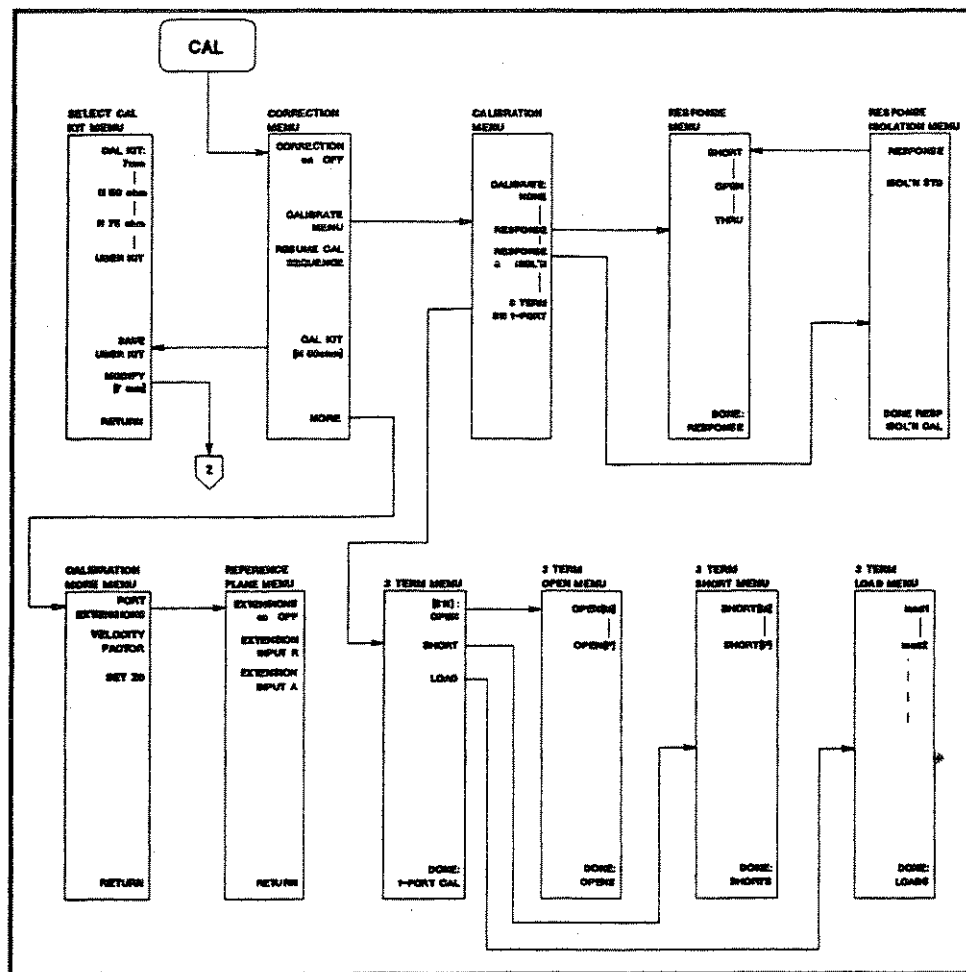

Figure 10-1. Softkey Menus Accessed from the **CAL** Key

The HP-IB programming command is shown in parenthesis following the key or softkey.

The **CAL** (KEY 15) key leads to a series of menus that implement the accuracy enhancement procedures described in the preceding pages (see Figure 10-1). Accuracy enhancement (error correction) is performed as a calibration step before measurement of a test device. The analyzer uses one of several different procedures to measure the systematic (repeatable) errors of the system and remove their effects from the measured data. The calibration menus and procedures are described and illustrated in the following pages. Each procedure compensates for one or more of the systematic error terms.

Interpolated Error Correction

The interpolated error correction feature allows the operator to change sweep range, or sweep type, without re-calibration. Interpolation is activated automatically when one or more of these stimulus parameters is changed as listed in the following table.

- Sweep range is changed to fall inside of the calibrated range.
- Sweep type is changed.
- Number of points is changed.

When interpolation is ON, the system errors for the newly selected frequencies are calculated from the system errors of the original calibration.

Note There is no softkey to turn OFF interpolation.



Interpolated error correction functions in all sweep modes: linear frequency, log frequency, and list sweep.

Channel Coupling

Up to four sets of measurement calibration data can be defined for each instrument state, one for each channel. If the two channels are stimulus coupled and the input ports are the same for both channels, they share the same calibration data. If the two channel inputs are different, they can have different calibration data. If the two channels are stimulus uncoupled, the measurement calibration applies to only one channel. For information on stimulus coupling, See Chapter 8.

Omitting Isolation Calibration

Isolation calibration can be omitted for most measurements, except where wide dynamic range is a consideration. Use the following guidelines. When the measurement requires a dynamic range of:

- under 80 dB: Omit isolation calibration for most measurements.
- 80 to 100 dB: Isolation calibration is recommended with approximately 0 dBm into the R input.
- over 100 dB: Averaging should be ON with an averaging factor ≥ 16 , both for isolation calibration and for measurement after calibration.

Stopping During the Calibration Procedure

You can stop at any point during a calibration procedure, without losing the steps you have already performed. No special steps are necessary to leave; just do whatever task you want. To continue the calibration where you left off, press **CAL** RESUME CAL SEQUENCE.

Saving Calibration Data

It is recommended that calibration data be saved on the built-in disk or in RAM disk memory. See Chapter 14. If a calibration is not saved, it will be lost if another calibration procedure is selected for the same channel. Instrument preset, power on, and instrument state recall will also clear the calibration data.

Specifying Calibration Kits

In addition to the menus for the different calibration procedures, the **CAL** key provides access to a series of menus used to specify the characteristics of the calibration standards used. Hewlett-Packard calibration kits are predefined, or the definitions can be modified to any set of standards used.

Correction Menu

The correction menu is the first menu presented by the **CAL** key, and it provides access to numerous menus of additional calibration features.

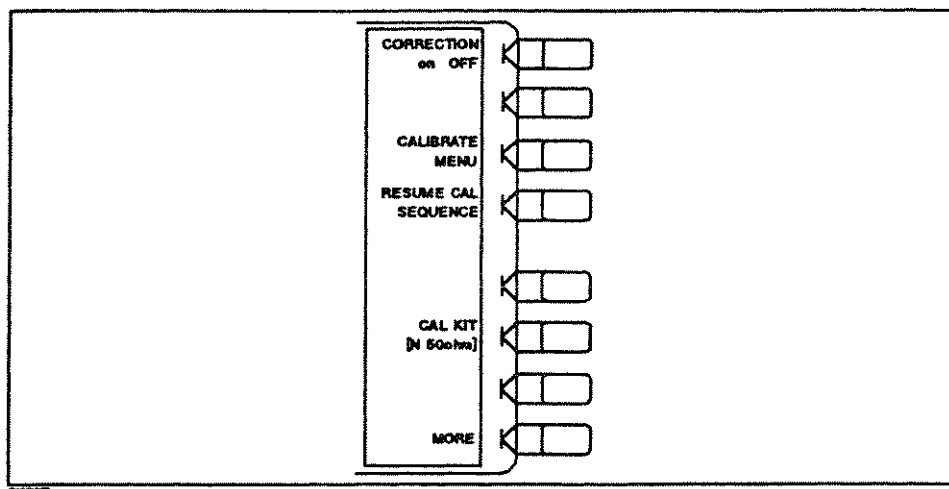

Figure 10-2. Correction Menu

CORRECTION on OFF (CORRON, CORROFF) turns error correction ON or OFF. The analyzer uses the most recent calibration data for the displayed parameter.

If one of the next stimulus parameters has been changed, correction is automatically turned OFF.

- Input measurement port is changed.
- Calibration type is changed.

If one of the next stimulus parameters has been changed, interpolated correction is automatically turned ON and the status notation is changed to "C?" (See "CRT Display" in Chapter 5).

- Sweep range is changed to fall inside of the calibrated range.
- Sweep type is changed.
- Number of Point is changed.

If one of the next stimulus parameters has been changed, the status notation is changed to "C!" (See "CRT Display" in Chapter 5). In this status, error corrections at a stimulus point will be done using calibration coefficient at the nearest calibrated frequency point.

- Sweep range is changed so both start and stop, or one of the start and stop stimulus values are/is out the calibrated range.

A calibration must be performed before correction can be turned ON. If no valid calibration data exists, the message "CALIBRATION REQUIRED" is displayed on the display.

It is recommended that calibration data be saved on the built-in disk or in RAM disk memory, using the capabilities described in Chapter 14.

CALIBRATE MENU leads to the calibration menu, which provides several accuracy enhancement procedures. At the completion of a calibration procedure, correction is automatically turned ON, and the notation "Cor" is displayed at the left of the screen.

RESUME CAL SEQUENCE (RESC) eliminates the need to restart a calibration sequence that was interrupted to access some other menu. This softkey goes back to the point where the calibration sequence was interrupted.

CAL KIT leads to the select cal kit menu, which selects one of the default calibration kits available for different connector types. This in turn leads to additional menus used to define calibration standards other than those in the default kits (See "Modifying Calibration Kits", later in this chapter). When a calibration kit has been specified, its connector type is displayed in brackets in the softkey label.

MORE provides access to the calibrate more menu, which extends the test port reference plane, to specify the characteristic impedance of the system, and the relative propagation velocity factor.

Select Cal Kit Menu

This selects the calibration kit for a measurement calibration. Selecting a cal kit chooses the model that mathematically describes the standard devices actually used.

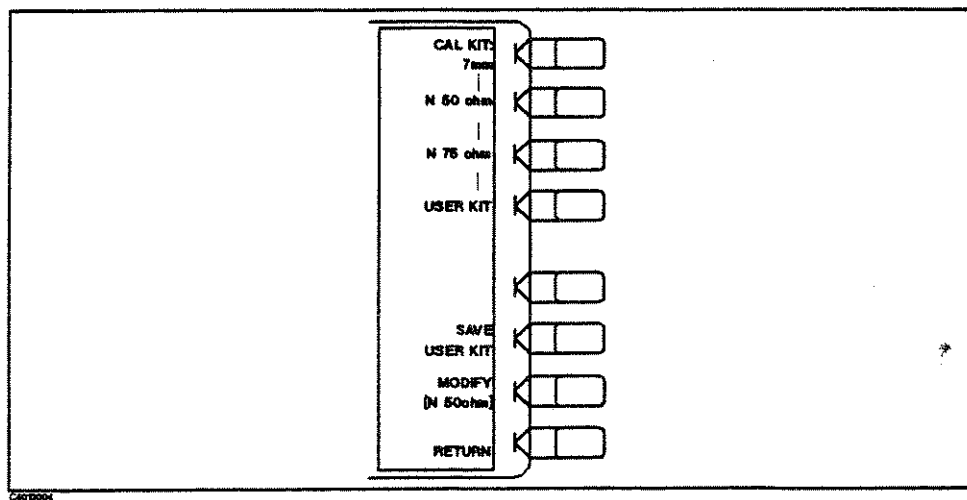

Figure 10-3. Select Cal Kit Menu

CAL KIT: 7mm (CALK7MM) selects the 7 mm cal kit model.

N 50Ω (CALKN50) selects the 50 Ω type-N model.

N 75Ω (CALKN75) selects the 75 Ω type-N model.

Note



If **N 50Ω** or **N 75Ω** is selected, additional menus are provided during calibration procedures to select the connector sex. This is the connector sex of the input port, not the actual calibration standard.

USER KIT (CALKUSED) selects a cal kit model defined or modified by the user. For information, See "Modifying Calibration Kits", later in this chapter.

SAVE USER KIT (SAVEUSEK) stores the user-modified or user-defined kit into memory, after it has been modified.

MODIFY (MODI1) leads to the modify cal kit menu, where a default cal kit can be user-modified.

RETURN returns to the correction menu.

Calibrate More Menu

This menu extends the test port reference plane, specifies the characteristic impedance of the system, and specifies the relative propagation velocity factor.

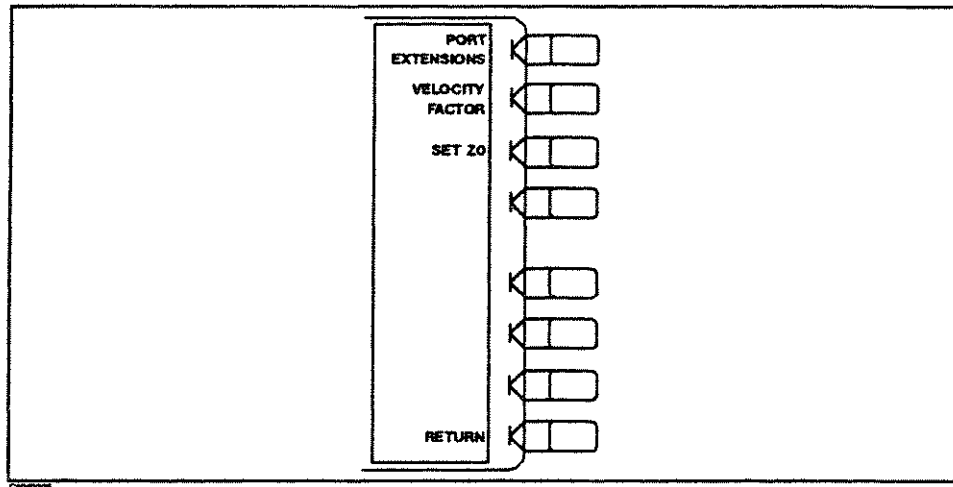

Figure 10-4. Calibrate More Menu

PORT EXTENSIONS goes to the reference plane menu, which extends the apparent location of the measurement reference plane or input.

The differences between the **PORT EXTENSIONS** and **ELECTRICAL DELAY** functions are described in the following table.

Table 10-1.
Differences between **PORT EXTENSIONS** and **ELECTRICAL DELAY**

	PORT EXTENSIONS	ELECTRICAL DELAY
Main Effect	The end of a cable becomes the test port plane for all measurements.	Compensates for the electrical length of a cable for the current type of measurement only.
Measurements Affected	All parameters.	Only the currently selected measurement parameter.

VELOCITY FACTOR (VELOFACT) enters the velocity factor used by the analyzer to calculate equivalent electrical length. Values entered should be less than 1. For example, the velocity factor of Teflon is:

$$V_f = \frac{1}{\sqrt{\epsilon_r}}$$

$$= 0.666$$

SET Z0 (SETZ) sets the characteristic impedance used by the analyzer in calculating measured impedance with conversion parameters. Characteristic impedance must be set correctly before calibration procedures are performed.

RETURN goes back to the correction menu.

Reference Plane Menu

This adds electrical delay in seconds to the measurement ports to extend the apparent location of the measurement reference plane to the ends of the cables. This is equivalent to adding a length of perfect air line, and makes it possible to measure the delay response of the DUT only, instead of the DUT plus the adapter, cable, or other incidental device. Read the previous description of Port Extension for more information.

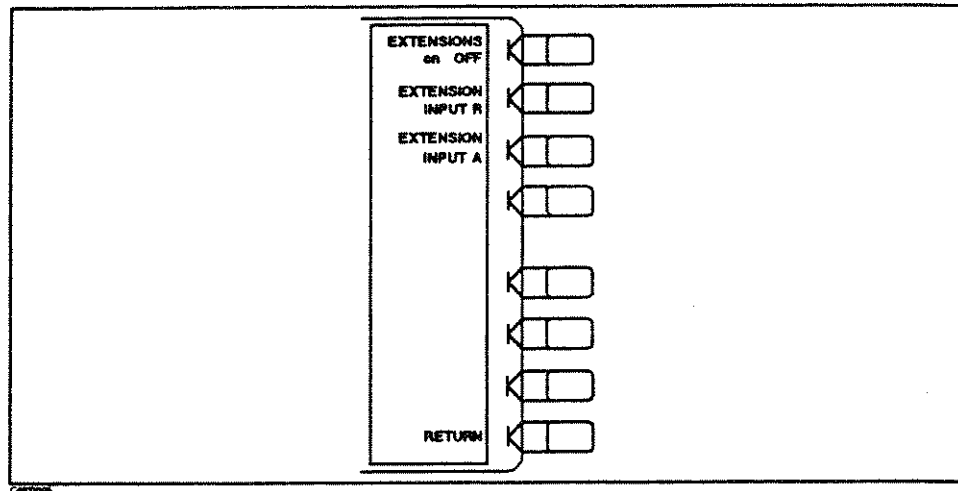

Figure 10-5. Reference Plane Menu

EXTENSIONS on OFF (POREON, POREOFF) toggles the reference plane extension mode. When this function is ON, all extensions defined below are enabled; when OFF, none of the extensions are enabled.

EXTENSION INPUT R (PORTR) adds electrical delay in seconds to extend the reference plane at input R to the end of the cable. This is used for any R input measurements.

EXTENSION INPUT A (PORTA) adds electrical delay to the input A reference plane for any A input measurements.

RETURN goes back to the calibrate more menu.

Calibration Menu

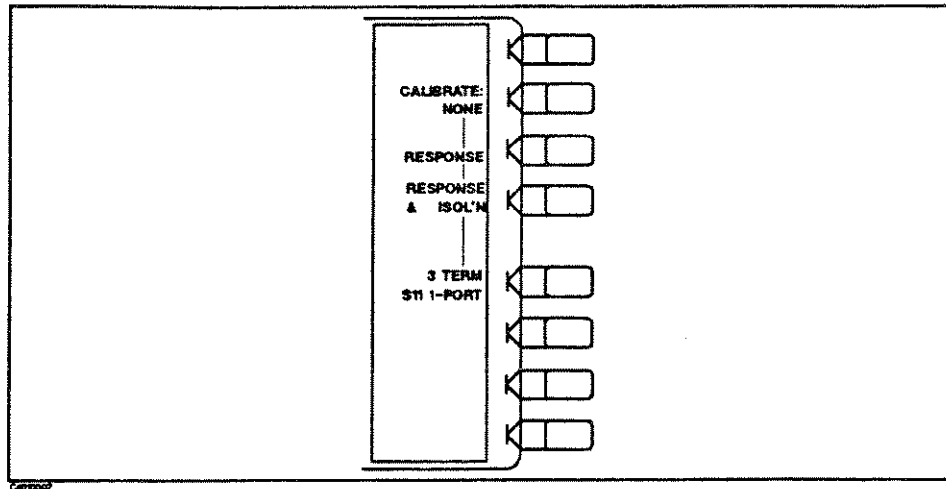

Figure 10-6. Calibration Menu

CALIBRATE: NONE (CALM) is underlined if no calibration has been performed or if the calibration data has been cleared. Unless a calibration is saved on the internal disk, the calibration data is lost on instrument preset, power ON, or instrument state recall. RESPONSE (CALIRESP) leads to the frequency response calibration. It effectively removes the frequency response errors of the test setup for transmission measurements.

Only a single calibration standard is required with this procedure. The standard for transmission measurements is a THRU. If more than one device is measured, only the data for the last device is retained. The procedures for response calibration for a reflection measurement and a transmission measurement are described in the following pages.

RESPONSE & ISOL'N (CALIRAI) leads to the menus used to perform a response and isolation measurement calibration, for measurement of devices with wide dynamic range. This procedure effectively reduces the same errors as the response calibration. In addition, it effectively reduces the isolation (crosstalk) error in transmission measurements. As well as the devices required for a simple response calibration, an isolation standard is required. The standard normally used to correct for isolation is an impedance-matched LOAD (usually 50 or 75 Ω). Response and directivity calibration procedures for transmission measurement is provided in the following pages.

3 TERM S11 1-PORT (CALIS111) leads to the menus used to perform a 3 term calibration (S_{11} 1-port measurement calibration). The 3 Term calibration procedures provide the same correction measurements as the S_{11} 1-port calibration of conventional network analyzers. This calibration also applies to error correction for the π network measurement to test crystal resonators.

Response Calibration for Transmission Measurements

This performs a frequency response only calibration for a transmission measurement.

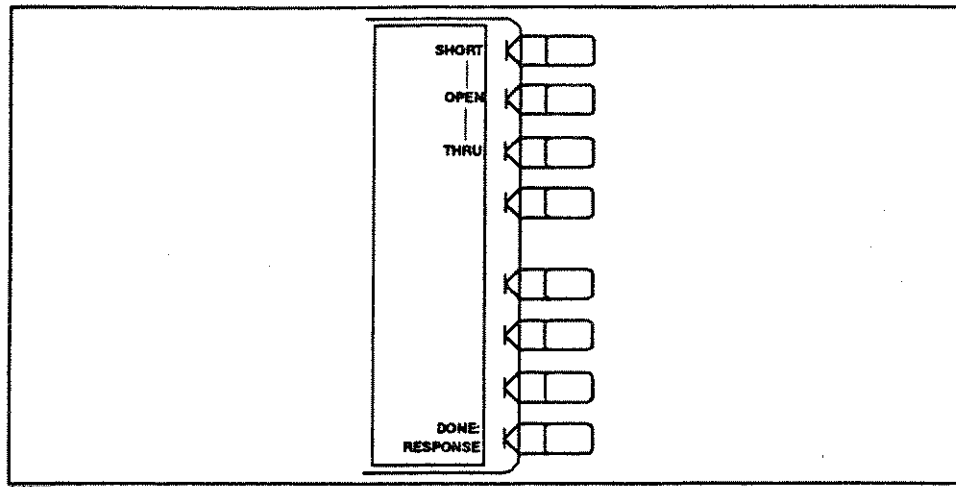

Figure 10-7. Response Cal Menu

Procedure

1. Press **MEAS** A/R.
2. Press **CAL**.
3. Press **CALIBRATE MENU RESPONSE**.
4. Connect a THRU (connect together the points at which the test device will be connected).
5. When the trace settles, press THRU.
6. The message "WAIT - MEASURING CAL STANDARD" is displayed while the data is measured. The softkey label THRU is then underlined.
7. Press **DONE: RESPONSE** to complete the calibration. The error coefficients are computed and stored. The correction menu is displayed with **CORRECTION ON**. Corrected data is displayed.

Now the test device can be connected and measured. It is recommended that calibration data be saved using the built-in disk drive. See Chapter 14.

Response and Isolation Calibration for Transmission Measurements

This effectively reduces the frequency response and isolation errors for transmission measurements of devices with wide dynamic range.

Procedure

1. Press **MEAS** A/R.
2. Press **CAL**.
3. Press **CALIBRATE MENU RESPONSE & ISOL'N RESPONSE**.
4. Connect a cable between RF Output 2 and Input R.

5. Connect a THRU between RF OUTPUT 1 and Input A at the points where the test device will be connected.
6. When the trace has settled, press **THRU**. Response data is measured. The softkey label **THRU** is underlined.
7. Press **DONE: RESPONSE**.
8. Connect impedance-matched LOADs to RF Output 1 and Input A. Press **ISOL'N STD**. The isolation data is measured. The softkey label is underlined.
9. Press **DONE RESP ISOL'N CAL** to complete the calibration. The error coefficients are computed and stored. The correction menu is displayed with **CORRECTION ON**. Corrected data is displayed and the notation "Cor" at the left of the screen indicates that correction is ON for this channel.

It is recommended that calibration data be saved on a built-in disk or in RAM disk memory. See Chapter 14.

Modifying Calibration Kits

Note



Hewlett-Packard strongly recommends that you read application note 8510-5A before attempting to view or modify calibration standard definitions. The part number of this application note is 5956-4352. Although the application note is written for the HP 8510 family of network analyzers, it also applies to the HP 87510A. This portion of the calibration chapter provides a summary of the information in the application note, as well as HP 87510A menu-specific information.

For most applications, use the default cal kit models provided in the select cal kit menu described earlier in this chapter. Modifying calibration kits is necessary only if unusual standards are used or the very highest accuracy is required. Unless a cal kit model is provided with the calibration devices used, a solid understanding of error correction and the system error model are absolutely essential to making modifications. Read the introductory part of this chapter for more information, and See the Appendix to Chapter 10.

Note



Numerical data for most Hewlett-Packard calibration kits is provided in the calibration kit manuals.

During measurement calibration, the analyzer measures actual, well-defined standards and mathematically compares the results with ideal "models" of those standards. The differences are separated into error terms which are later reduced during error correction. Most of the differences are due to systematic errors - repeatable errors introduced by the analyzer, test set, and cables - which are correctable. However, the difference between the standard's mathematical *model* and its *actual performance* has an adverse affect; it reduces the system's ability to remove systematic errors, and thus degrades error-corrected accuracy. Therefore, in addition to the default cal kit models, a "user kit" is provided that can be modified to an alternate calibration standards model.

Several situations exist that may require a user-defined cal kit:

- You use a connector interface different from the three built-in cal kits. (Examples: SMA, or BNC.)
- You are using standards (or combinations of standards) that are different from the predefined cal kits. (Example: Using three offset SHORTs instead of OPEN, SHORT, and LOAD to perform a 1-port calibration.)
- You want to improve the built-in standard models for predefined kits. Remember that the more closely the model describes the actual performance of the standard, the better the calibration. (Example: The 7 mm LOAD is determined to be 50.4 Ω instead of 50.0 Ω .)
- Unused standards for a given cal type can be eliminated from the default set, to eliminate possible confusion during calibration. (Example: A certain application requires calibrating a male test port. The standards used to calibrate a female test port can be eliminated from the set, and will not be displayed during calibration.)

Definitions

The following are definitions of terms:

- A **standard** is a specific, well-defined, physical device used to determine systematic errors.
- A **standard type** is one of five basic types that define the form or structure of the model to be used with that standard (e.g. SHORT or LOAD).
- **Standard coefficients** are numerical characteristics of the standards used in the model selected.
- A **standard class** is a grouping of one or more standards that determines which standards are used in a particular calibration procedure.

Procedure

The following steps are used to modify or define a user kit:

1. Select the predefined kit to be modified. This is not necessary for defining a new cal kit.
2. Define the standards. For each standard, define which *type* of standard it is and its electrical characteristics.
3. Specify the *class* where the standard is to be assigned.
4. Store the modified cal kit.

The standard definitions of predefined calibration kits are shown in Appendix B.

Modify Cal Kit Menu

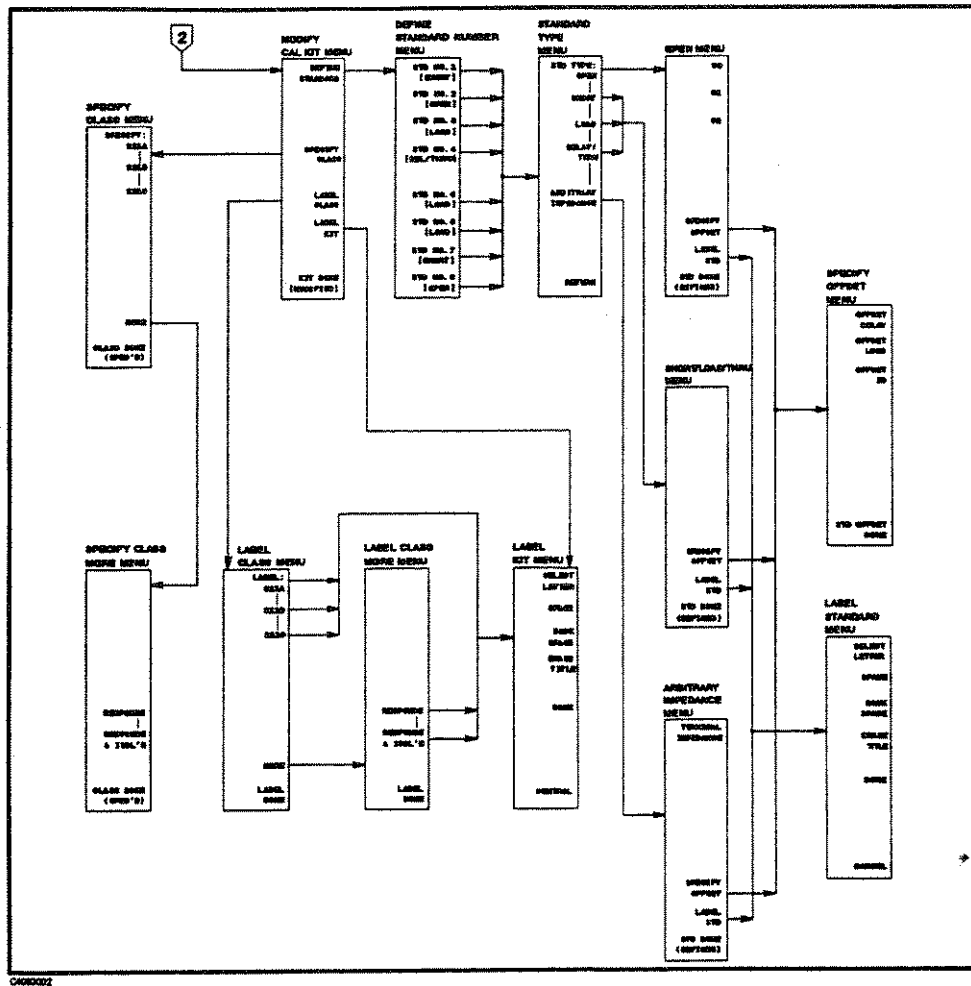

Figure 10-8. Modify Cal Kit Menus

This menu is accessed from **CAL CAL KIT MODIFY** (See Figure 10-1), and leads to additional menus associated with modifying cal kits. The analyzer directly supports 7 mm, 50 Ω type-N, and 75 Ω type-N connector types.

For other connector types, you must modify the existing standards definitions. This menu provides access to the default calibration standards definitions. A "User Kit" is provided for convenience. It can be redefined without affecting the definitions.

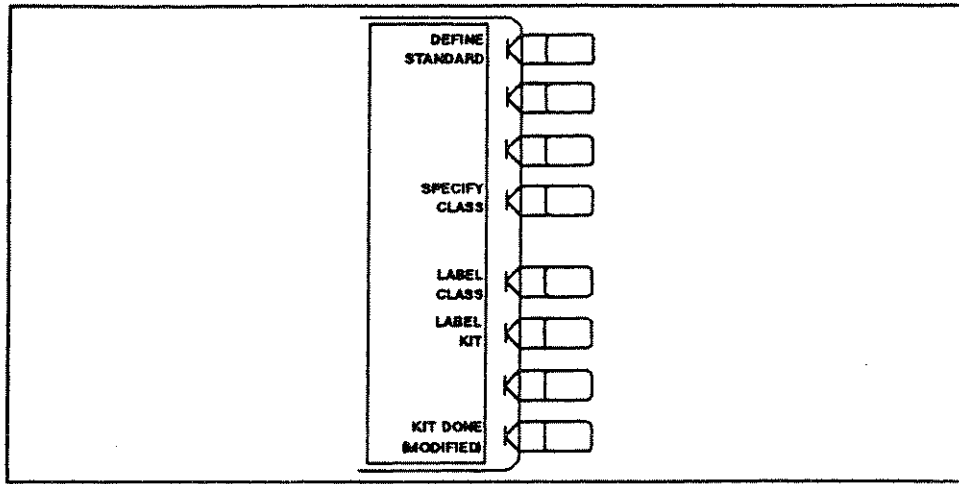

Figure 10-9. Modify Cal Kit Menu

DEFINE STANDARD (DEFS) makes the standard number the active function, and brings up the define standard number menus. The standard number (1 to 8) is an arbitrary reference number used to reference standards while specifying a class. Each number is similar to a register, in that it holds certain information. Each contains the selected type of device (OPEN, SHORT, or THRU) and the electrical model for that device. The standard numbers for the predefined calibration kits are as follows:

1 SHORT	5 LOAD
2 OPEN	6 LOAD
3 LOAD	7 SHORT
4 DEL/THRU	8 OPEN

SPECIFY CLASS leads to the specify class menu. After the standards are modified, use this key to specify a class to consist of certain standards.

LABEL CLASS leads to the label class menu, to give the class a meaningful label for future reference.

LABEL KIT (LABK) leads to a menu for constructing a label for the user-modified cal kit. If a label is supplied, it will appear as one of the five softkey choices in the select cal kit menu. The approach is similar to defining a display title, except that the kit label is limited to ten characters. See **DISPLAY** Key, Title Menu in Chapter 9 for details.

KIT DONE (KITD) terminates the cal kit modification process, after all standards are defined and all classes are specified. Be sure to save the kit with the **SAVE USER KIT** softkey, if it is to be used later.

Define Standard Number Menu

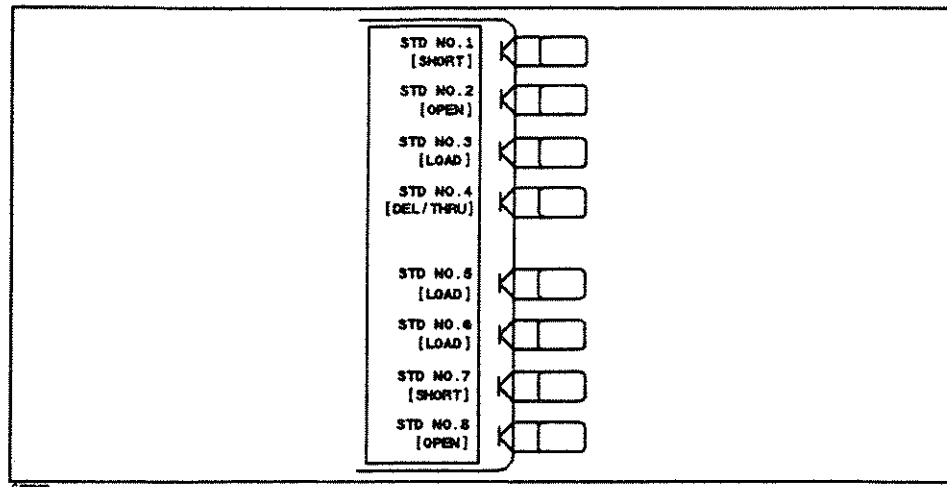

Figure 10-10. Define Standard Number Menu

STD NO. 1 selects standard No.1 as the standard definition.

STD NO. 2 selects standard No.2 as the standard definition.

STD NO. 3 selects standard No.3 as the standard definition.

STD NO. 4 selects standard No.4 as the standard definition.

STD NO. 5 selects standard No.5 as the standard definition.

STD NO. 6 selects standard No.6 as the standard definition.

STD NO. 7 selects standard No.7 as the standard definition.

STD NO. 8 selects standard No.8 as the standard definition.

Define Standard Menus

Standard definition is the process of mathematically modeling the electrical characteristics (delay, attenuation, and impedance) of each calibration standard. These electrical characteristics (coefficients) can be mathematically derived from the physical dimensions and material of each calibration standard, or from its actual measured response. The parameters of the standards can be listed in Standards Definitions, Table 10-2. The menus illustrated in Figure 10-10 specify the type and characteristics for each user-defined standard.

Table 10-2. Standard Definitions

NO.	STANDARD TYPE	C0 x 10 ⁻¹⁵ F	C1 x 10 ⁻²⁷ F/Hz	C2 x 10 ⁻³⁶ F/Hz ²	OFFSET DELAY ps	OFFSET LOSS MΩ/s	OFFSET Z ₀ Ω	STANDARD LABEL
1								
2								
3								
4								
5								
6								
7								
8								

Each standard must be identified as one of five “types”: OPEN, SHORT, LOAD, DELAY/THRU, or arbitrary impedance.

After a standard number is entered, selection of the standard type will present one of five menus for entering the electrical characteristics (model coefficients) corresponding to that standard type. These menus are tailored to the current type, so that only characteristics applicable to the standard type can be modified.

Any standard type can be further defined with offsets in delay, loss, and standard impedance (Z₀). Press the **SPECIFY OFFSET** key, and See the specify offset menu.

A distinct label can be defined and assigned to each standard, so that the analyzer can prompt the user with explicit standard labels during calibration (e.g. “SHORT”). Press the **LABEL STD** softkey. The function is similar to defining a display title, except that the label is limited to ten characters. See **DISPLAY** Key, “Title Menu” in Chapter 9 for details. After each standard is defined, including offsets, press **STD DONE (DEFINED)** to terminate the standard definition.

The standard definitions can be listed on screen and printed using the COPY function. (See Chapter 13.)

OPEN (STDTOPEN) defines the standard type as an OPEN, used for calibrating reflection measurements. OPENS are assigned a terminal impedance of infinite ohms, but delay and loss offsets may still be added. Pressing this key also brings up a menu for defining the OPEN, including its capacitance.

As a reflection standard, an OPEN offers the advantage of broadband frequency coverage. However, an OPEN rarely has perfect reflection characteristics because fringing (capacitance) effects cause phase shift that varies with frequency. These effects are impossible to eliminate, but the calibration kit models include the OPEN termination capacitance at all frequencies for compatible calibration kits. The capacitance model is a second order polynomial (squared term), as a function of frequency, where the polynomial coefficients are user-definable. The capacitance model equation is:

$$C = C_0 + C_1 \times F + C_2 \times F^2$$

where F is the measurement frequency.

The terms in the equation are defined with the specify open menu as follows:

C0 (C0) enters the C₀ term, which is the constant term of the quadratic equation and is scaled by 10⁻¹⁵ Farads.

C1 (C1) enters the C_1 term, expressed in F/Hz (Farads/Hz) and scaled by 10^{-27} .

C2 (C2) enters the C_2 term, expressed in F/Hz² and scaled by 10^{-36} .

SHORT (STDTSHOR) defines the standard type as a SHORT, for calibrating reflection measurements. SHORTs are assigned a terminal impedance of 0 Ω , but delay and loss offsets may still be added.

LOAD (STDTLOAD) defines the standard type as a LOAD (termination). LOADs are assigned a terminal impedance equal to the system characteristic impedance Z_0 , but delay and loss offsets may still be added. If the LOAD impedance is not Z_0 , use the arbitrary impedance standard definition.

DELAY/THRU (STDTDELA) defines the standard type as a transmission line of specified length, for calibrating transmission measurements.

ARBITRARY IMPEDANCE (STDTARBI) defines the standard type to be a LOAD, but with an arbitrary impedance (different from system Z_0).

TERMINAL IMPEDANCE (TERI) specifies the (arbitrary) impedance of the standard, in ohms.

STD DONE(DEFINED) terminates the standard definition. Press this after each standard defined, including offsets.

Specify Offset Menu

The specify offset menu allows additional specifications for a user-defined standard. Features specified in this menu are common to all five types of standards.

Offsets may be specified with any standard type. This means defining a uniform length of transmission line to exist between the standard being defined and the actual measurement plane. For reflection standards, the offset is assumed to be between the measurement plane and the standard (one-way only). For transmission standards, the offset is assumed to exist between the two reference planes (in effect, the offset is the THRU). Three characteristics of the offset can be defined: its delay (length), loss, and impedance.

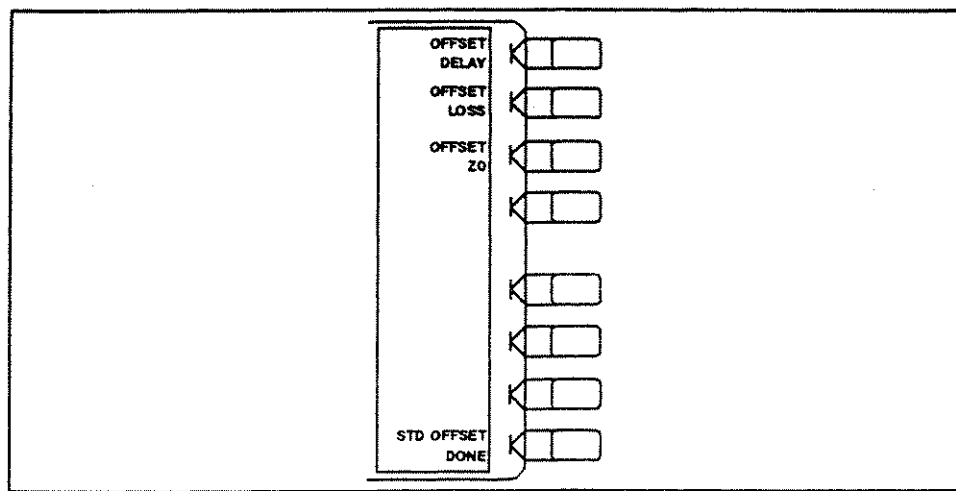

Figure 10-11. Specify Offset Menu

OFFSET DELAY (OFSD) specifies the one-way electrical delay from the measurement (reference) plane to the standard, in seconds (s). (In a transmission standard, offset delay is the delay from plane to plane.) Delay can be calculated from the precise physical length of the offset, the permittivity constant of the medium, and the speed of light.

OFFSET LOSS (OFSL) specifies energy loss, due to skin effect, along a one-way length of coaxial cable offset. The value of loss is entered as ohms/nanosecond (or Giga ohms/second) at 1 GHz.

OFFSET Z0 (OFSZ) specifies the characteristic impedance of the coaxial cable offset.

Note This is not the impedance of the standard itself.



Label Standard Menu

This menu labels (reference) individual standards during the menu-driven measurement calibration sequence. The labels are user-definable using a character set displayed on the display that includes letters, numbers, and some symbols, and they may be up to ten characters long. The analyzer will prompt you to connect standards using these labels, so they should be meaningful to you, and distinct for each standard.

By convention, when sexed connector standards are labeled male (m) or female (f), the designation refers to the test port connector sex, not the connector sex of the standard.

Standard labels are created in the same way as titles. See “**DISPLAY** Key” in Chapter 9, “Title Menu” in Chapter 9.

Specify Class Menus

Once a standard is specified, it must be assigned to a standard *class*. This is a group of from one to seven standards that is required to calibrate for a single error term. The standards within a single class are assigned to locations A through G as listed on the Standard Class Assignments Table (Table 10-3). A class often consists of a single standard, but may be composed of more than one standard.

The standard class assignments of predefined standard kits are shown in Appendix B.

Table 10-3. Standard Class Assignments Table

CLASS	A	B	C	D	E	F	G	STANDARD CLASS LABEL
S _{11A}								
S _{11B}								
S _{11C}								
Response								
Response & Isolation								

The number of standard classes required depends on the type of calibration being performed, and is identical to the number of error terms corrected. (Examples: A response cal requires only one class, and the standards for that class may include an OPEN, or SHORT, or THRU. A 1-port cal requires three classes.)

The number of standards that can be assigned to a given class may vary from none (class not used) to one (simplest class) to seven. When a certain class of standards is required during calibration, the analyzer will display the labels for all the standards in that class (except when the class consists of a single standard). This does not, however, mean that all standards in a class must be measured during calibration. Only a single standard per class is required. Note that it is often simpler to keep the number of standards per class to the bare minimum needed (often one) to avoid confusion during calibration.

Standards are assigned to a class simply by entering the standard's reference number (established while defining a standard) under a particular class.

Each class can be given a user-definable label as described under "Label Class Menu".

The class assignments table can be displayed on screen and printed using the COPY function. (See Chapter 13.)

SPECIFY: S11A (SPECS11A) enters the standard numbers for the first class required for a 3-term calibration. (For predefined cal kits, this is OPEN (for the 7 mm) or OPENS (for type-N).)

S11B (SPECS11B) enters the standard numbers for the second class required for a 3-term calibration. (For predefined cal kits, this is SHORT (for the 7 mm) or SHORTS (for the type-N) .)

S11C (SPECS11C) enters the standard numbers for the third class required for a 3-term calibration. (For predefined kits, this is the LOAD.)

MORE leads to the following softkeys.

RESPONSE (SPECRESP) enters the standard numbers for a response calibration. This calibration corrects for frequency response in either reflection or transmission measurements, depending on the parameter being measured when a calibration is performed. (For predefined kits, the standard is either the OPEN or SHORT for reflection measurements, or the THRU for transmission measurements.)

RESPONSE & ISOL'N (SPECRESI) enters the standard numbers for a response & isolation calibration. This calibration corrects for frequency response and directivity in reflection measurements, or frequency response and isolation in transmission measurements.

Label Class Menu

These define meaningful labels for the calibration classes. These then become softkey labels during a measurement calibration. Labels can be up to ten characters long.

Labels are created in the same way as display titles. See **DISPLAY** Key, "Title Menu" in Chapter 9.

Label Kit Menu

After a new calibration kit has been defined, be sure to specify a label for it. Choose a label that describes the connector type of the calibration devices. This label will then appear in the **CAL KIT** softkey label in the correction menu and the **MODIFY** label in the select cal kit menu. It will be saved with calibration data.

This menu is accessed with the **LABEL KIT** softkey in the modify cal kit menu, and is identical to the label class menu and the label standard menu described above. It allows definition of a label up to eight characters long.

Verify Performance

Once a measurement calibration has been generated with a user-defined calibration kit, its performance should be checked before making device measurements. To check the accuracy that can be obtained using the new calibration kit, a device with a well-defined frequency response should be measured. The verification device must not be one of the calibration standards: measurement of one of these standards is merely a measure of repeatability.

To achieve more complete verification of a particular measurement calibration, accurately known verification standards with a diverse magnitude and phase responses should be used. NIST traceable or HP standards are recommended to achieve verifiable measurement accuracy.

Note



The published specifications for the HP 87510A network analyzer system include accuracy enhancement with compatible calibration kits. Measurement calibrations made with user-defined or modified calibration kits are not subject to the HP 87510A specifications, although a procedure similar to the system verification procedure may be used.

Using Markers

MKR Key

The HP-IB programming command is shown in parenthesis following the key or softkey.

The **MKR** key displays a movable active marker (∇) on the screen and provides access to a series of menus to control one to eight display markers for each channel (a total of sixteen). Markers obtain numerical readings of measured values. They also provide capabilities for reducing measurement time by changing stimulus parameters, searching the trace for specific values, or statistically analyzing part or all of the trace.

Markers have a stimulus value (the x-axis value in Cartesian format) and a response value (the y-axis value in a Cartesian format). In a polar chart format, the second part of a complex data pair is also provided as an auxiliary response value. When a marker is turned ON and no other function is active, its stimulus value is displayed in the active entry area and can be controlled with the knob, the step keys, or the numeric keypad. The active marker can be moved to any point on the trace, and its response and stimulus values are displayed at the top right corner of the graticule for each displayed channel, in units appropriate to the display format. The displayed marker response values are valid even when the measured data is above or below the range displayed on the graticule. When the marker list is turned ON, the stimulus values and response values of all markers are listed on the graticule.

When the marker time mode is turned ON, the x-axis is changed to the time scale, where the start point of the x-axis is 0 seconds and the stop point indicates the sweep time and markers have a time instead of a stimulus value.

Marker values are normally continuous: that is, they are interpolated between measured points. Alternatively, they can be set to read only discrete measured points. The markers for the two channels normally have the same stimulus values, or they can be uncoupled so that each channel has independent markers, regardless of whether stimulus values are coupled or dual channel display is ON.

If both the data trace and the sub trace are displayed using LOGMAG & PHASE or LOGMAG & DELAY format, you can select which marker values apply to the data trace or the sub trace.

With the use of a reference marker, a delta marker mode is available that displays both the stimulus and response values of the active marker relative to the reference. Any of the eight markers or a fixed point can be designated as the delta reference marker. If the delta reference is one of the eight markers, its stimulus value can be controlled by the user and its response value is the value of the trace at that stimulus value. If the delta reference is a fixed marker, both its stimulus value and its response value can be set arbitrarily by the user anywhere in the display area (not necessarily on the trace).

Markers can search for the trace maximum, minimum, mean point, any other point, peak maximum, minimum or peak-to-peak value of all or part of the trace. The eight markers can be used together to search for specified bandwidth cutoff points and to calculate the bandwidth. Statistical analysis uses markers to provide a readout of the mean, standard deviation, and peak-to-peak values of all or part of the trace.

The menus accessed from the **MKR** key (Figure 11-1) provide several basic marker operations. These include different marker modes for different display formats, and the delta marker mode that displays marker values relative to a specified value.

Marker Menu

The marker menu (Figure 11-2) goes to the activate marker menu or clear marker menu to turn the display markers ON or OFF, to assign a markers to a data trace or sub trace, to list marker values, or to gain access to the marker delta mode and other marker modes and formats.

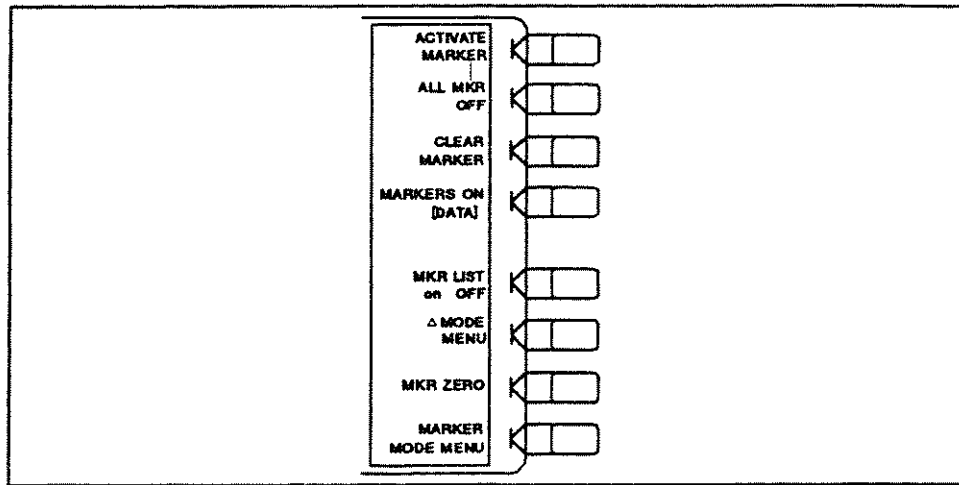

Figure 11-2. Marker Menu

ACTIVATE MARKER goes to the activate marker menu, from which the marker are activated.

ALL MKR OFF (MARKOFF) turns OFF all the markers and the delta reference marker, as well as the tracking and bandwidth functions that are accessed with the **MKR FCTN** key.

CLEAR MARKER goes to the clear marker menu, from which to turn OFF a marker.

MARKERS ON [DATA] (MARKODATA, MARKOMEMO) selects the data trace data or the sub trace to be applied for the marker values when the LOG MAG & PHASE or LOG MAG & DELAY format is selected.

MKR LIST on off (MARKLON, MARKLOFF) lists stimulus values and response values of all markers. In Δ mode, this lists all delta markers and fixed markers.

Δ MODE MENU goes to the delta marker menu, which reads the difference in values between the active marker and a reference marker.

MKR ZERO (MARKZERO) puts a fixed reference marker at the present active marker position, and sets the fixed marker stimulus and response values at that position equal to zero. All subsequent stimulus and response values of the active marker are then read out relative to the fixed marker. The fixed marker is shown on the display as a small triangle " Δ " (delta), smaller than the inactive marker triangles. The softkey label changes from **MKR ZERO** to **MKR ZERO Δ REF = Δ** and the notation " Δ REF= Δ " is displayed at the top right corner of the

graticule. The marker zero is canceled by turning the delta mode OFF from the delta marker menu or turning all the markers OFF with the **ALL MKR OFF** softkey.

MARKER MODE MENU provides access to the marker mode menu, where several marker modes can be selected including special markers for polar chart format.

Activate marker menu

This menu (Figure 11-3) turns the display markers ON and to designate the active marker.

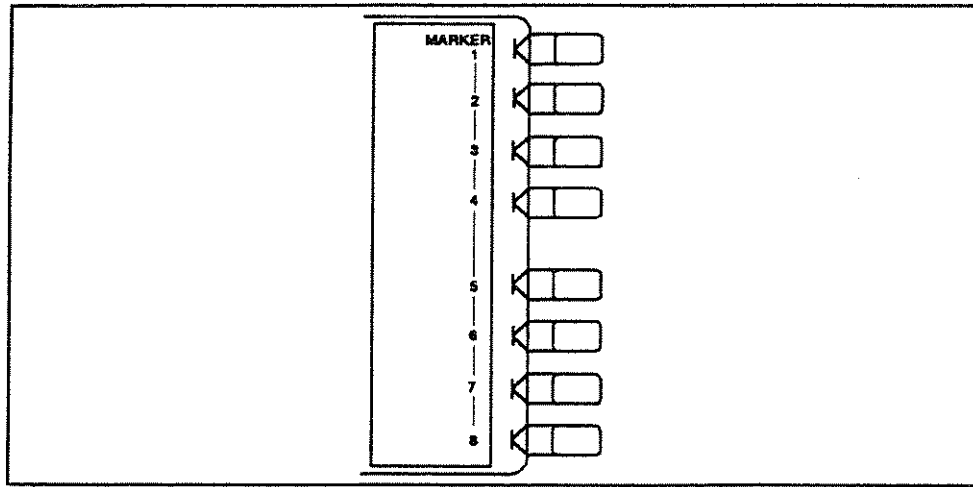

Figure 11-3. Activate Marker Menu

MARKER 1 (MARK1) turns on marker 1 and makes it the active marker. The active marker appears on the display as "▽". The active marker stimulus value is displayed in the active entry area, together with the marker number. If there is a marker turned ON, and no other function is active, the stimulus value of the active marker can be controlled with the knob, the step keys, or the numeric keypad. The marker response and stimulus values are displayed in the upper right-hand corner of the screen.

MARKER 2 (MARK2) turns ON marker 2 and makes it the active marker. If another marker is present, that marker becomes inactive and is represented on the display as "△".

MARKER 3 (MARK3) turns ON marker 3 and makes it the active marker.

MARKER 4 (MARK4) turns ON marker 4 and makes it the active marker.

MARKER 5 (MARK5) turns ON marker 5 and makes it the active marker.

MARKER 6 (MARK6) turns ON marker 6 and makes it the active marker.

MARKER 7 (MARK7) turns ON marker 7 and makes it the active marker.

MARKER 8 (MARK8) turns ON marker 8 and makes it the active marker.

Clear Marker Menu

This menu (Figure 11-4) turns the display markers OFF. If an activated marker is cleared, the marker of lowest number, if any, will be activated.

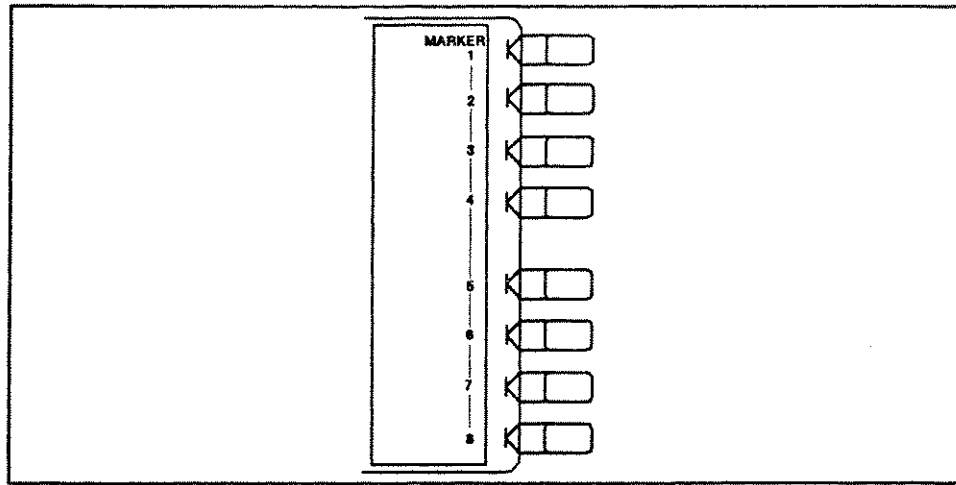

Figure 11-4. Clear Marker Menu

MARKER 1 (CLEM1) turns OFF marker 1.

MARKER 2 (CLEM2) turns OFF marker 2.

MARKER 3 (CLEM3) turns OFF marker 3.

MARKER 4 (CLEM4) turns OFF marker 4.

MARKER 5 (CLEM5) turns OFF marker 5.

MARKER 6 (CLEM6) turns OFF marker 6.

MARKER 7 (CLEM7) turns OFF marker 7.

MARKER 8 (CLEM8) turns OFF marker 8.

Delta Marker Mode Menu

The delta marker mode reads the difference in stimulus and response values between the active marker and a designated delta reference marker. Any of the eight markers or a fixed point can be designated as the reference marker. If the reference is one of the eight markers, its stimulus value can be controlled by the user and its response value is the value of the trace at that stimulus value. If the reference is a fixed marker, both its stimulus value and its response value can be set arbitrarily by the user anywhere in the display area. The delta reference is shown on the display as a small triangle Δ (delta), smaller than the inactive marker triangles (Δ). If one of the markers is the reference, the triangle appears next to the marker number on the trace.

The marker values displayed in this mode are the stimulus and response values of the active marker minus the reference marker. If the active marker is also designated as the reference marker, the marker values are zero.

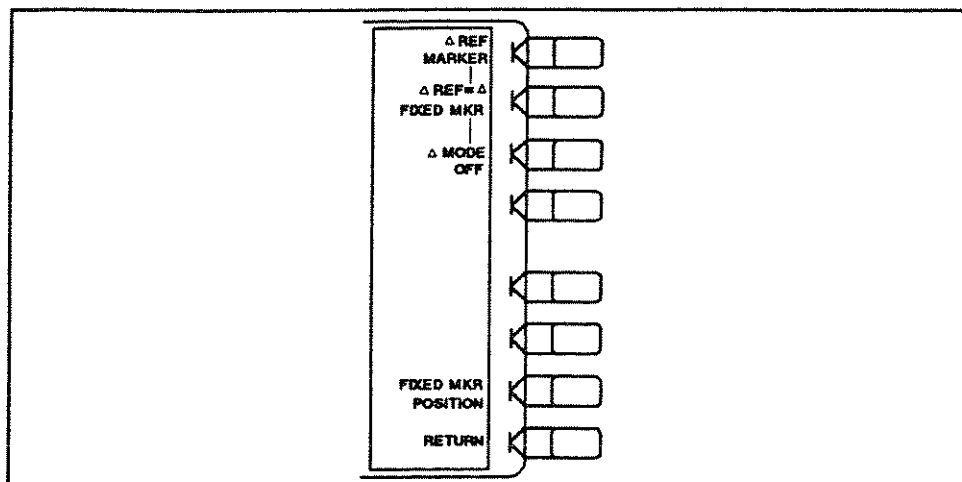

Figure 11-5. Delta Marker Mode Menu

Δ REF MARKER goes to the delta marker menu, which makes a marker the delta reference.

ΔREF=Δ FIXED MKR (DELRFIXM) sets a user-specified fixed reference marker. The stimulus and response values of the reference can be set arbitrarily, and can be anywhere in the display area. Unlike markers 1 to 8, the fixed marker need not be on the trace. The fixed marker is indicated by a small triangle Δ , and the active marker stimulus and response values are shown relative to this point. The notation " Δ REF= Δ " is displayed at the top right corner of the graticule.

Pressing this softkey turns ON the fixed marker. Its stimulus and response values can then be changed using the fixed marker menu, which is accessed with the **FIXED MKR POSITION** softkey described below. Alternatively, the fixed marker can be set to the current active marker position, using the **MKR ZERO** softkey in the marker menu.

Δ MODE OFF (DELO) turns OFF the delta marker mode, so that the values displayed for the active marker are absolute values.

FIXED MKR POSITION leads to the fixed marker menu, where the stimulus and response values for a fixed reference marker can be set arbitrarily.

RETURN goes back to the marker menu.

Delta Marker Menu

This menu (Figure 11-6) establishes a marker as a delta reference. The active marker stimulus and response values are shown relative to this delta reference. If marker 1 has been selected as the delta reference, **ΔREF=1** is underlined in this menu, and the marker menu is returned to the screen. In the activate marker menu under **ACTIVATE MARKER**, the first key is now labeled **MARKER Δ REF = 1**. The notation " Δ REF=1" appears at the top right corner of the graticule.

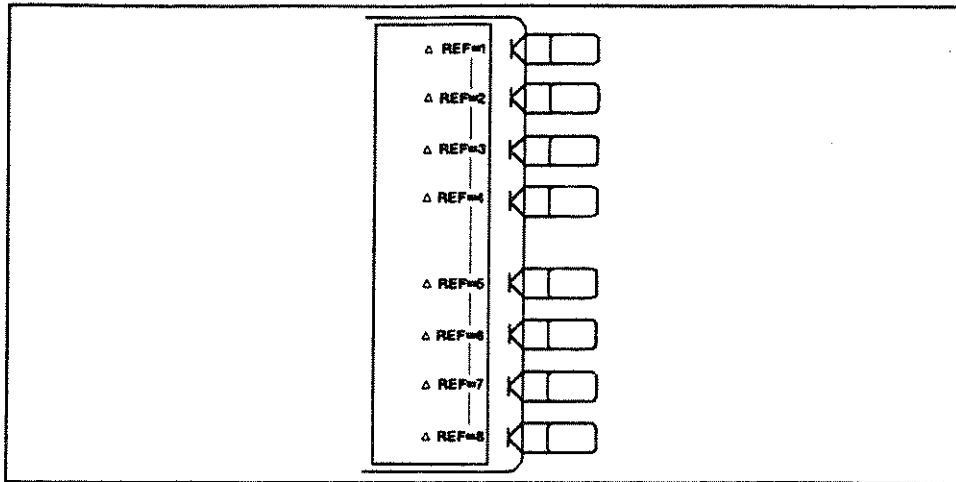

Figure 11-6. Delta Marker Menu

Δ REF = 1 (DELR1) makes marker 1 the delta reference.

Δ REF = 2 (DELR2) makes marker 2 the delta reference.

Δ REF = 3 (DELR3) makes marker 3 the delta reference.

Δ REF = 4 (DELR4) makes marker 4 the delta reference.

Δ REF = 5 (DELR5) makes marker 5 the delta reference.

Δ REF = 6 (DELR6) makes marker 6 the delta reference.

Δ REF = 7 (DELR7) makes marker 7 the delta reference.

Δ REF = 8 (DELR8) makes marker 8 the delta reference.

Fixed Marker Menu

This menu sets the position of a fixed reference marker, indicated on the display by a small triangle Δ . Both the stimulus value and the response value of the fixed marker can be set arbitrarily anywhere in the display area, and need not be on the trace. The units are determined by the display format and the marker type.

There are two ways to turn ON the fixed marker. One way is with the Δ REF = Δ FIXED MKR softkey in the delta marker mode menu. The other is with the MKR ZERO function in the marker menu, which puts a fixed reference marker at the present active marker position and makes the marker stimulus and response values at that position equal to zero.

The softkeys in this menu make the values of the fixed marker the active function. The marker readings in the top right corner of the graticule are the stimulus and response values of the active marker minus the fixed reference marker. Also displayed in the top right corner is the notation " Δ REF= Δ ".

The stimulus value, response value, and auxiliary response value (the second part of a complex data pair) can be individually examined and changed. This allows active marker readings that are relative in amplitude yet absolute in frequency, or any combination of relative/absolute

readouts. Following a **MKR ZERO** operation, this menu can reset any of the fixed marker values to absolute zero for absolute readings of the subsequent active marker values.

If the format is changed while a fixed marker is ON, the fixed marker values become invalid. For example, if the value offset is set to 10 dB with a log magnitude format, and the format is then changed to phase, the value offset becomes 10 degrees. However, in polar chart format, the specified values remain consistent between different marker types for those formats.

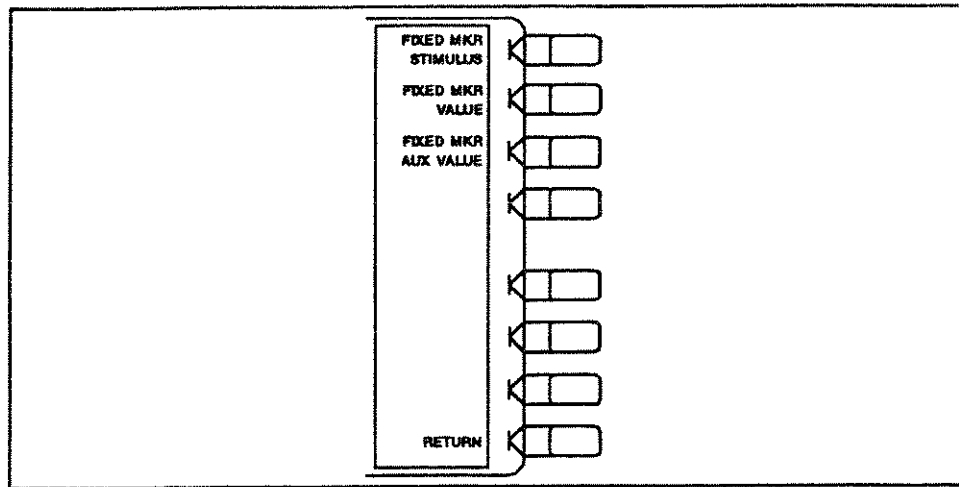

Figure 11-7. Fixed Marker Menu

FIXED MKR STIMULUS (MARKFSTI) changes the stimulus value of the fixed marker. Fixed marker stimulus values can be different for the two channels if the channel markers are uncoupled using the marker mode menu.

Absolute active marker stimulus values can be read, if the stimulus value is set to zero.

FIXED MKR VALUE (MARKFVAL) changes the response value of the fixed marker. In a Cartesian format this is the y-axis value. In a polar chart format with a magnitude/phase marker or a real/imaginary marker, this applies to the first part (real part) of the complex data pair. Fixed marker response values are always uncoupled in the two channels.

Absolute active marker response values can be read, if the response value is set to zero.

FIXED MKR AUX VALUE (MARKFAUV) is used only with a polar format. It changes the auxiliary response value of the fixed marker. This is the second part (imaginary part) of a complex data pair, and applies to a magnitude/phase marker or a real/imaginary marker. Fixed marker auxiliary response values are always uncoupled in the two channels.

Absolute active marker auxiliary response values can be read, if the auxiliary value is set to zero.

RETURN goes back to the delta marker mode menu.

Marker Mode Menu

This menu provides different marker modes and makes available an additional menu of special markers for use in the polar format.

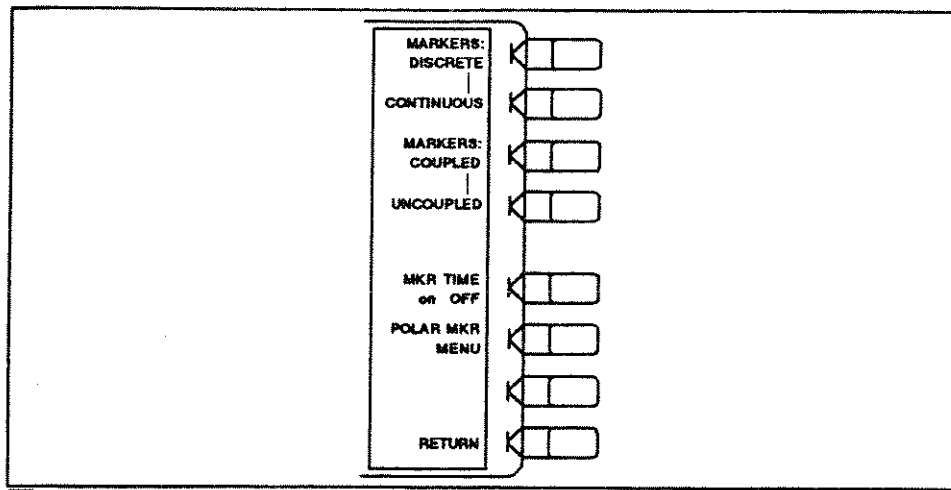

Figure 11-8. Marker Mode Menu

MARKERS: DISCRETE (MARKDISC) places markers only on measured trace points determined by the stimulus settings.

CONTINUOUS (MARKCONT) interpolates between measured points to allow the markers to be placed at any point on the trace. Displayed marker values are also interpolated. This is the default marker mode.

MARKERS: COUPLED (MARKCOUP) couples the marker stimulus values for the two display channels. Even if the stimulus is uncoupled and two sets of stimulus values are shown, the markers track the same stimulus values on each channel as long as they are within the displayed stimulus range.

UNCOUPLED (MARKUNCO) allows the marker stimulus values to be controlled independently on each channel.

MKR TIME on OFF (MARKTIMEON, MARKTIMEOFF) sets the x-axis units to time, where the start point is zero and the stop point is the value of the sweep time. A marker indicates the time passed after the sweep has started. This function is useful for testing a DUT's time transition characteristics at a certain fixed frequency by setting span to zero.

POLAR MKR MENU leads to the polar marker menu.

RETURN goes back to the marker menu.

Polar Marker Menu

This menu is used only with the polar display format, selectable using the **FORMAT** key. In the polar format, the magnitude at the center of the circle is zero and the outer circle is the full scale value set in the scale reference menu. Phase is measured as the angle counterclockwise from 0° at the positive x-axis. The analyzer automatically calculates different mathematical forms of the marker magnitude and phase values, selected using the softkeys in this menu. Marker frequency is displayed in addition to other values regardless of the marker type selected.

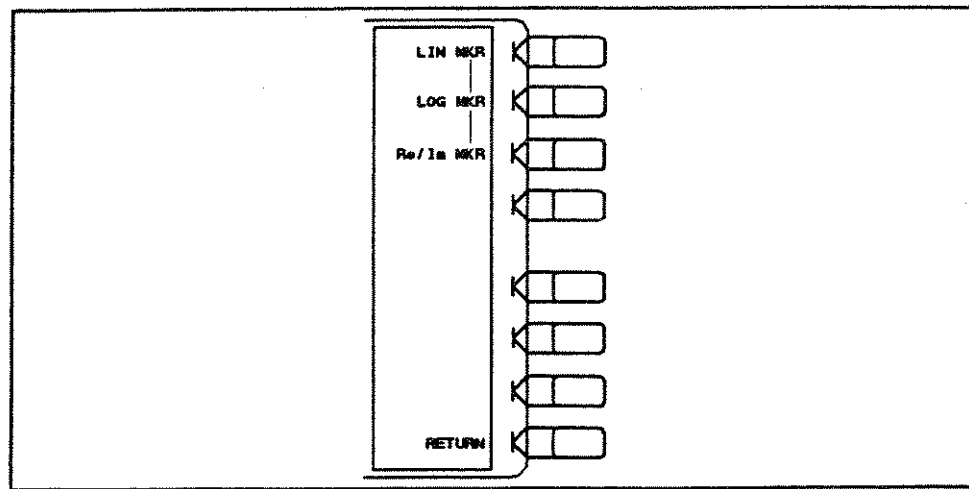

Figure 11-9. Polar Marker Menu

LIN MKR (POLMLIN) displays a readout of the linear magnitude and the phase of the active marker. This is the preset marker type for a polar display. Magnitude values are read in engineering units and phase in degrees.

LOG MKR (POLMLOG) displays the logarithmic magnitude and the phase of the active marker. Magnitude values are expressed in dB and phase in degrees. This is useful as a fast method of obtaining a reading of the log magnitude value without changing to the log magnitude format.

Re/Im MKR (POLMRI) displays the values of the active marker as a real and imaginary pair. The complex data is separated into its real part and its imaginary part. The first marker value given is the real part ($= M \cos \theta$), and the second value is the imaginary part ($= M \sin \theta$), where M = magnitude.

RETURN goes back to the marker mode menu.

MKR FCTN Key

The HP-IB programming command is shown in parenthesis following the key or softkey.

The MKR FCTN (KEY 17) key activates a marker if one is not already active, and provides access to additional marker functions. These can quickly change the measurement parameters, to search the trace for specified information, and to analyze the trace statistically.

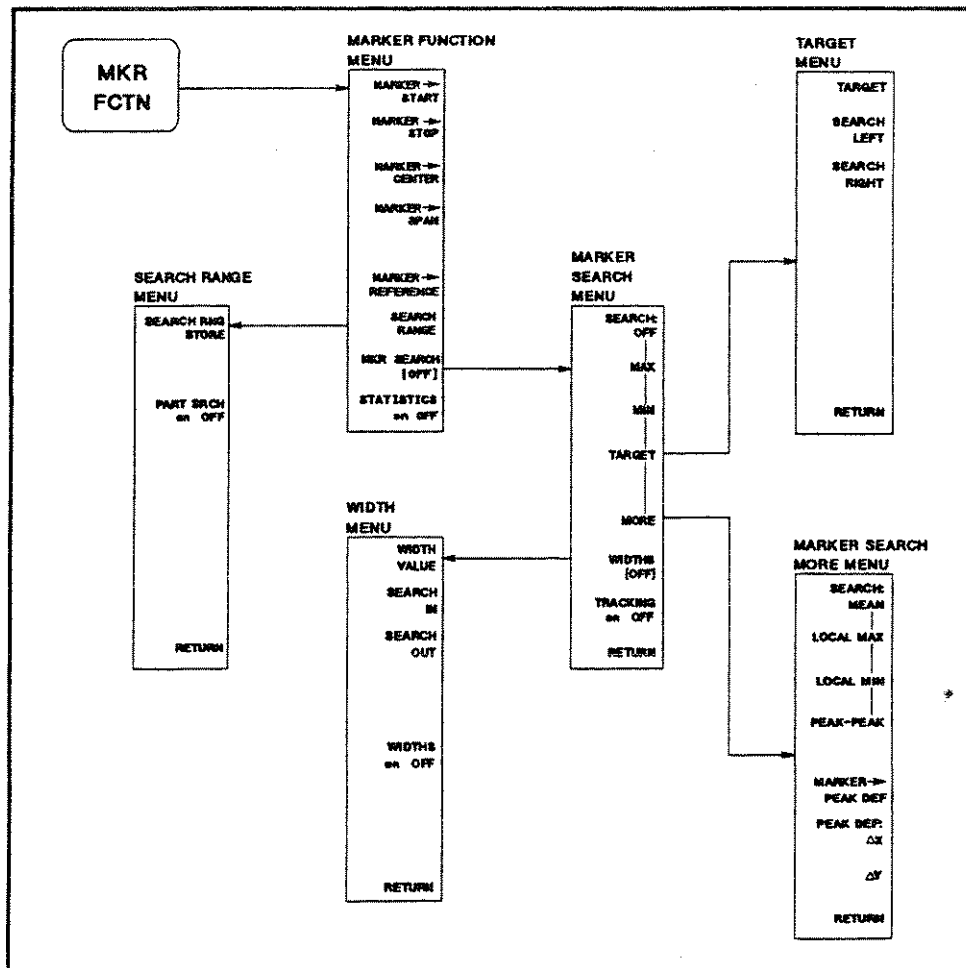

Figure 11-10. Menus Accessed from the MKR FCTN Key

Marker Function Menu

This menu provides softkeys that use markers to quickly modify certain measurement parameters without going through the usual key sequence. In addition, it provides access to five additional menus used for searching the trace, for storing the search range, and for statistical analysis.

The MARKER → functions change certain stimulus and response parameters to make them equal to the current active marker value. Use the knob or the numeric keypad to move the marker to the desired position on the trace, and press the appropriate softkey to set the specified parameter to that trace value. When the values have been changed, the marker can again be moved within the range of the new parameters.

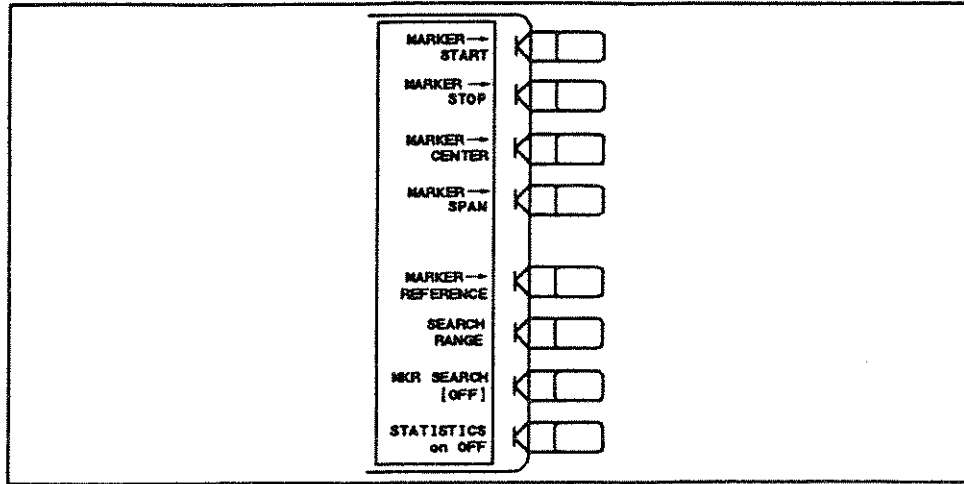

Figure 11-11. Marker Function Menu

MARKER → START (MARKSTAR) changes the stimulus start value to the stimulus value of the active marker.

MARKER → STOP (MARKSTOP) changes the stimulus stop value to the stimulus value of the active marker.

MARKER → CENTER (MARKCENT) changes the stimulus center value to the stimulus value of the active marker, and centers the new span about that value.

MARKER → SPAN (MARKSPAN) changes the Start and Stop values of the stimulus span to the values of the active marker and the delta reference marker. If there is no reference marker, the message "NO MARKER DELTA - SPAN NOT SET" is displayed.

MARKER → REFERENCE (MARKREF) equals the reference value to the active marker's response value, without changing the reference position. In the polar format, the full scale value at the outer circle is changed to the active marker response value. This softkey also appears in the scale reference menu.

SEARCH RANGE leads to the search range menu, which defines the range for partial search and to turn the partial search ON or OFF.

MKR SEARCH leads to the marker search menu, which searches the trace for a particular value or bandwidth.

STATISTICS (MEASTATON, MEASTATOFF) calculates and displays the mean, standard deviation, and peak-to-peak values of the section of the displayed trace in the search range defined in Search Range Menu. If Partial Search is off, the statistics are calculated for the entire trace. A convenient use of this feature is to find the peak-to-peak value of passband ripple without searching separately for the maximum and minimum values.

The statistics are absolute values: For the polar format, the statistics are calculated using the first value of the complex pair (magnitude or real part).

Search Range Menu

This menu specifies and activates the range over which the marker search functions are effective. This function is useful if a part of the entire stimulus range is analyzed.

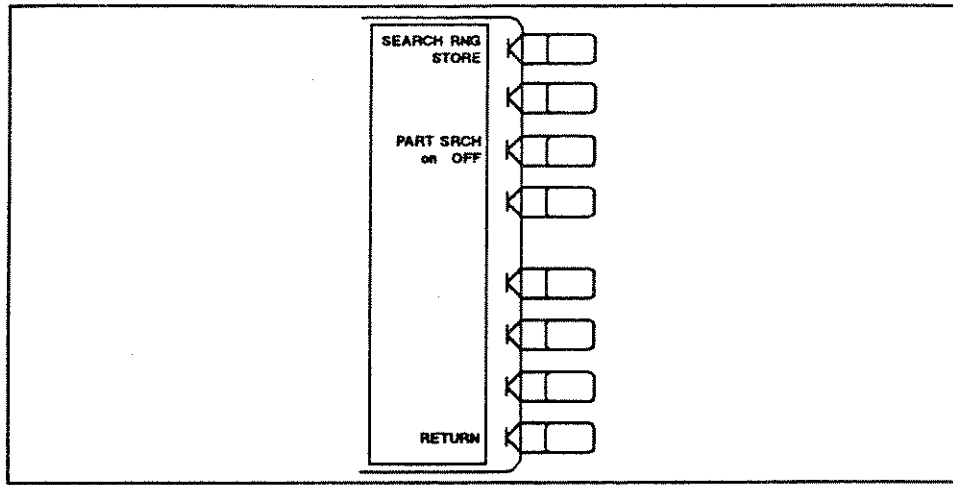

Figure 11-12. Search Range Menu

SEARCH RNG STORE (SEARSTOR) stores a search range, which is defined between the active marker and the delta reference marker. If there is no reference marker, the message "NO MARKER DELTA - RANGE NOT SET" is displayed.

PART SRCH on OFF (PARSON, PARSOFF) turns partial search ON or OFF. The search range is displayed by two small triangles, "Δ", at the bottom of the graticule. If no search range is defined, the search range is the entire trace.

RETURN goes back to the marker function menu.

Marker Search Menu

This menu searches the trace for a specific amplitude-related point, and places the marker on that point, and to lead more menu for searching in a partial range of the trace. The capability of searching for a specified bandwidth is also provided. Tracking is available for a continuous sweep-to-sweep search. If there is no occurrence of a specified value or bandwidth, the message "TARGET VALUE NOT FOUND" is displayed.

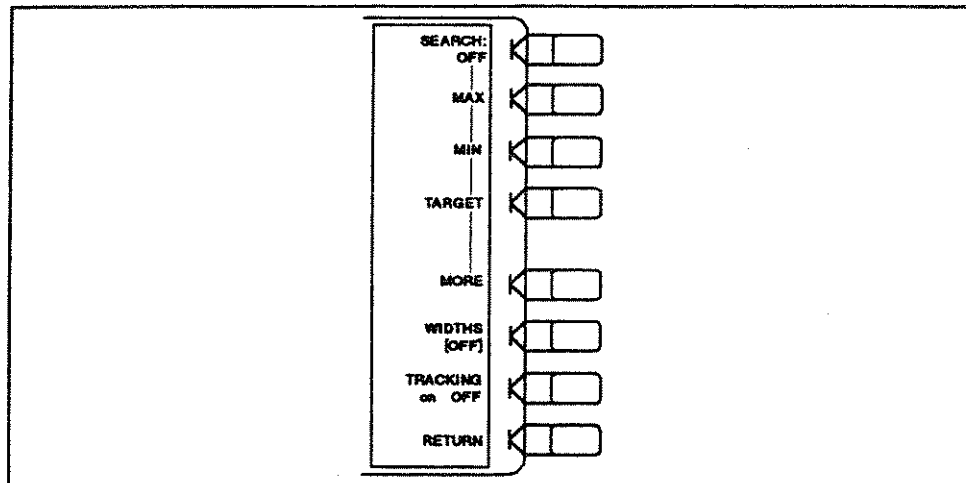

Figure 11-13. Marker Search Menu

SEARCH: OFF (SEAOFF) turns OFF the marker search function.

MAX (SEAMAX) moves the active marker to the maximum point on the trace. In polar format, LIN and LOG markers searches on $|\Gamma|$, and other types of marker searches on real part of measurement parameter.

MIN (SEAMIN) moves the active marker to the minimum point on the trace. In polar format, LIN and LOG markers searches on $|\Gamma|$.

TARGET (SEATARG) places the active marker at a specified target point on the trace. The target menu is presented, providing search right and search left options to resolve multiple solutions.

For relative measurements, a search reference must be defined with a delta marker or a fixed marker before the search is activated.

MORE goes to the marker search more menu.

WIDTHS leads to the width menu, which is used to define the START and STOP points for a bandwidth search, and to turn bandwidth search ON and OFF.

TRACKING on OFF (TRACKON, TRACKOFF) is used in conjunction with other search features to track the search with each new sweep. Turning ON tracking makes the analyzer search every new trace for the specified target value and put the active marker on that point.

When tracking is OFF, the target is found on the current sweep and remains at the same stimulus value regardless of changes in trace response value with subsequent sweeps.

A maximum and a minimum point can be tracked simultaneously using two channels and uncoupled markers.

RETURN goes back to the marker function menu.

Target Menu

The target menu places the marker at a specified target response value on the trace, and provides search right and search left options. If there is no occurrence of the specified value, the message "TARGET VALUE NOT FOUND" is displayed.

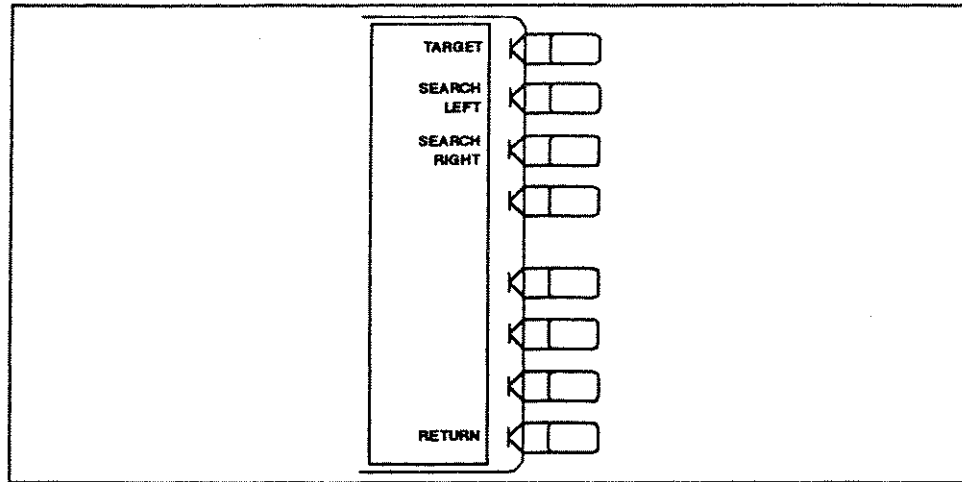

Figure 11-14. Target Menu

TARGET (SEATARG) places the marker at the specified target response value. If tracking is ON (see previous menu) the target is automatically tracked with each new trace. If tracking is OFF, the target is found each time this key is pressed. The target value is in units appropriate to the current format. The default target value is -3 dB.

In delta marker mode, the target value is the value relative to the reference marker. If no delta reference marker is ON, the target value is an absolute value.

SEARCH LEFT (SEAL) searches the trace for the next occurrence of the target value to the left.

SEARCH RIGHT (SEAR) searches the trace for the next occurrence of the target value to the right.

RETURN goes back to the marker search menu.

Marker Search More Menu

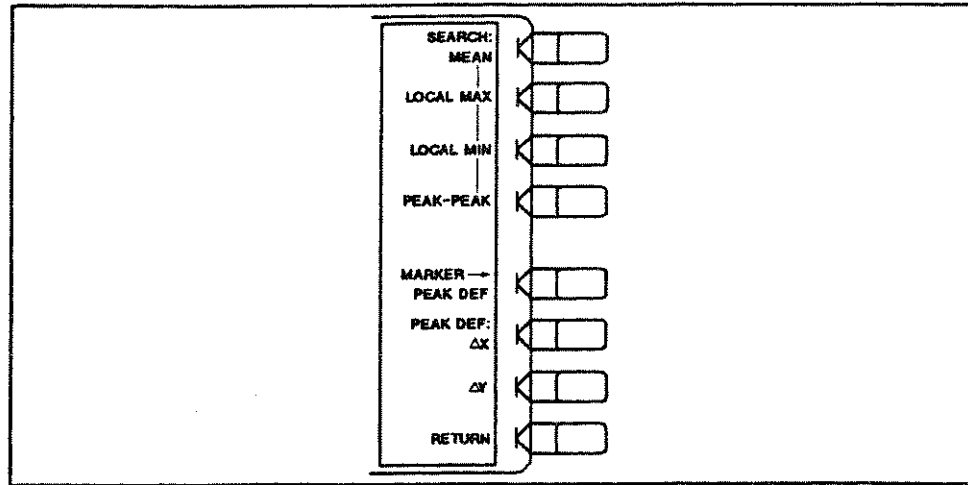

Figure 11-15. Marker Search More Menu

SEARCH: MEAN (SEAMEAN) moves the active marker to the mean point on the trace (in the search range if it has been specified).

LOCAL MAX (SEALMAX) moves the active marker to the maximum *peak* point on the trace in the search range stored in the search range menu. The applicable peak profile is defined by the **MARKER → PEAK DEF** or **PEAK DEF: ΔX** and **ΔY** keys described below.

LOCAL MIN (SEALMIN) moves the active marker to the minimum *peak* point on the trace in the search range stored in the search range menu. The applicable peak profile is defined by the **MARKER → PEAK DEF** or **PEAK DEF: ΔX** and **ΔY** keys described below.

PEAK-PEAK (SEAPPEAK) moves the active marker and the delta reference marker to the maximum peak point and the minimum peak point on the trace in the search range. The applicable peak profile is defined by the **MARKER → PEAK DEF** or **PEAK DEF: ΔX** and **ΔY** keys described below. This turns ON the delta mode regardless of the current marker mode.

MARKER → PEAK DEF (MARKPEAD) changes the differential stimulus value (ΔX) and response value (ΔY) of the peak for searching for the local max, min, and peak-to-peak to the respective differential values between active and reference markers.

PEAK DEF: ΔX (PEADX) defines the differential stimulus value (ΔX) of the peak for searching for the local max, min, and peak-to-peak.

ΔY (PEADY) defines the differential response value (ΔY) of the peak for searching for the local max, min, and peak-to-peak.

Note For Peak Define

The **PEAK DEF: ΔX** and **ΔY** softkeys define the peak profile to be applicable for the **LOCAL MAX**, **LOCAL MIN**, and **PEAK-PEAK** functions. These functions search a peak where, the positive-going shoulder gradient is greater than $\Delta Y/\Delta X$, and the negative-going shoulder gradient is less than $-\Delta Y/\Delta X$. Therefore, the peak define function can limit the applicable peak to certain sharpness regardless its absolute value. The greater $\Delta Y/\Delta X$, the sharper the peak.

Example: To analyze a spurious peak on a trace, shown in Figure 11-16, using the **LOCAL MAX** softkey, specify $\Delta Y/\Delta X$, larger than that of the fundamental peak $\Delta Y_1/\Delta X_1$, (expected not to be detected) and smaller than that of the spurious peak $\Delta Y_2/\Delta X_2$ (expected to detect). This filters out the fundamental peak from the search.

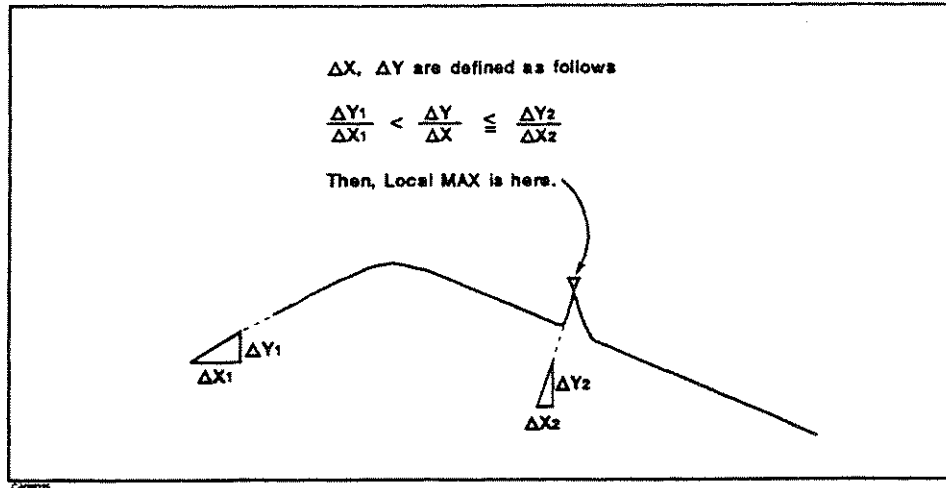

Figure 11-16. Peak Definition Example

The applicable peak is only specified by the ratio, $\Delta x/\Delta y$. The absolute values of Δx and Δy do not matter.

RETURN goes back to the marker search menu.

Width Menu

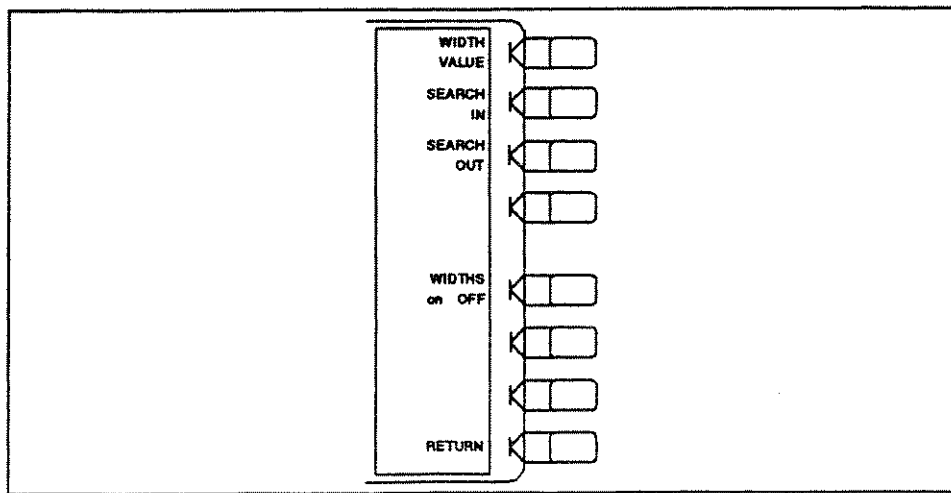

Figure 11-17. Width Menu

WIDTH VALUE (WIDV) sets the amplitude parameter (for example -3 dB) that defines the Start and Stop points for a bandwidth search. The bandwidth Search feature analyzes a bandpass or band reject trace and calculates the center point, bandwidth, and Q (quality factor) for the

specified bandwidth. Bandwidth units are in the units of the current format. When Δ mode is ON, the bandwidth value specified is the deference from the delta reference.

SEARCH IN (WIDSIN) searches for the cutoff point on the trace within the current cutoff points.

SEARCH OUT (WIDSON) searches for the cutoff point on the trace outside of the current cutoff points.

WIDTHS ON OFF (WIDTON, WIDTOFF) turns ON the bandwidth search feature and calculates the center stimulus value, bandwidth, Q, insertion loss, and cutoff point deviation from the center of a bandpass or band reject shape on the trace. The amplitude value that defines the passband or rejectband is set using the **WIDTH VALUE** softkey.

When **WIDTHS** is turned ON, if the active marker is 1, 2, 3, or 4, markers 1, 2, 3, and 4 are turned ON, and each is assigned to a dedicated use. Marker 1 is the starting point from which the search is begun. Marker 2 is the bandwidth center point. Marker 3 is the bandwidth cutoff point on the left, and marker 4 is the cutoff point on the right. If the active marker is the 5, 6, 7, or 8, markers 5, 6, 7, and 8 move in the same manner as above for markers 1, 2, 3, and 4.

The width parameters obtained are also listed on the display as follows:

- BW** displays the bandwidth value set by the **WIDTH VALUE** softkey.
- cent** displays the center stimulus value between cutoff points, which is marked by the marker 2 (, or 6).
- Q** displays the Q value (= cent/BW) of the trace.
- Insertion Loss** displays the absolute value of the marker 1 (, or 5).
- ΔF (left)** displays the stimulus value difference between markers 3 (or 5) and center frequency specified by the **CENTER** key.
- ΔF (right)** displays the stimulus value difference between markers 4 (or 8) and center frequency specified by the **CENTER** key.

Figure 11-18 shows an example of the bandwidth search feature.

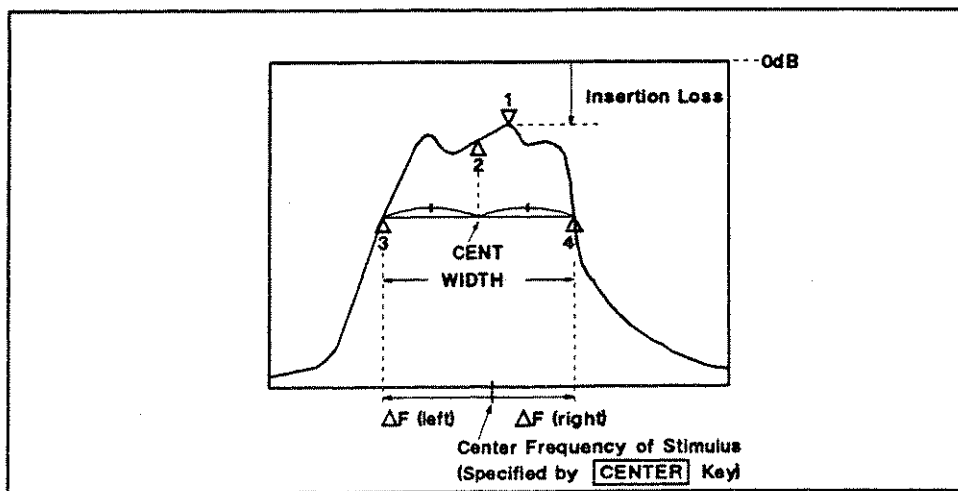

Figure 11-18. Bandwidth Search Example

If a delta marker or fixed marker is ON, it is used as the reference point from which the bandwidth amplitude is measured. For example, if marker 1 is the delta marker and is set at the passband maximum, and the width value is set to -3 dB, the bandwidth search finds the bandwidth cutoff points 3 dB below the maximum and calculates the 3 dB bandwidth and Q.

If marker 2 (the dedicated bandwidth center point marker) is the delta reference marker, the search finds the points 3 dB down from the center.

If no delta reference marker is set, the bandwidth values are absolute values.

In the expanded phase mode, this function searches the two cutoff points whose values are "+ WIDTH VALUE", and "-WIDTH VALUE". For example, when the width value is 45°, the cutoff points' values are $\pm 45^\circ$.

RETURN goes back to the marker search menu.

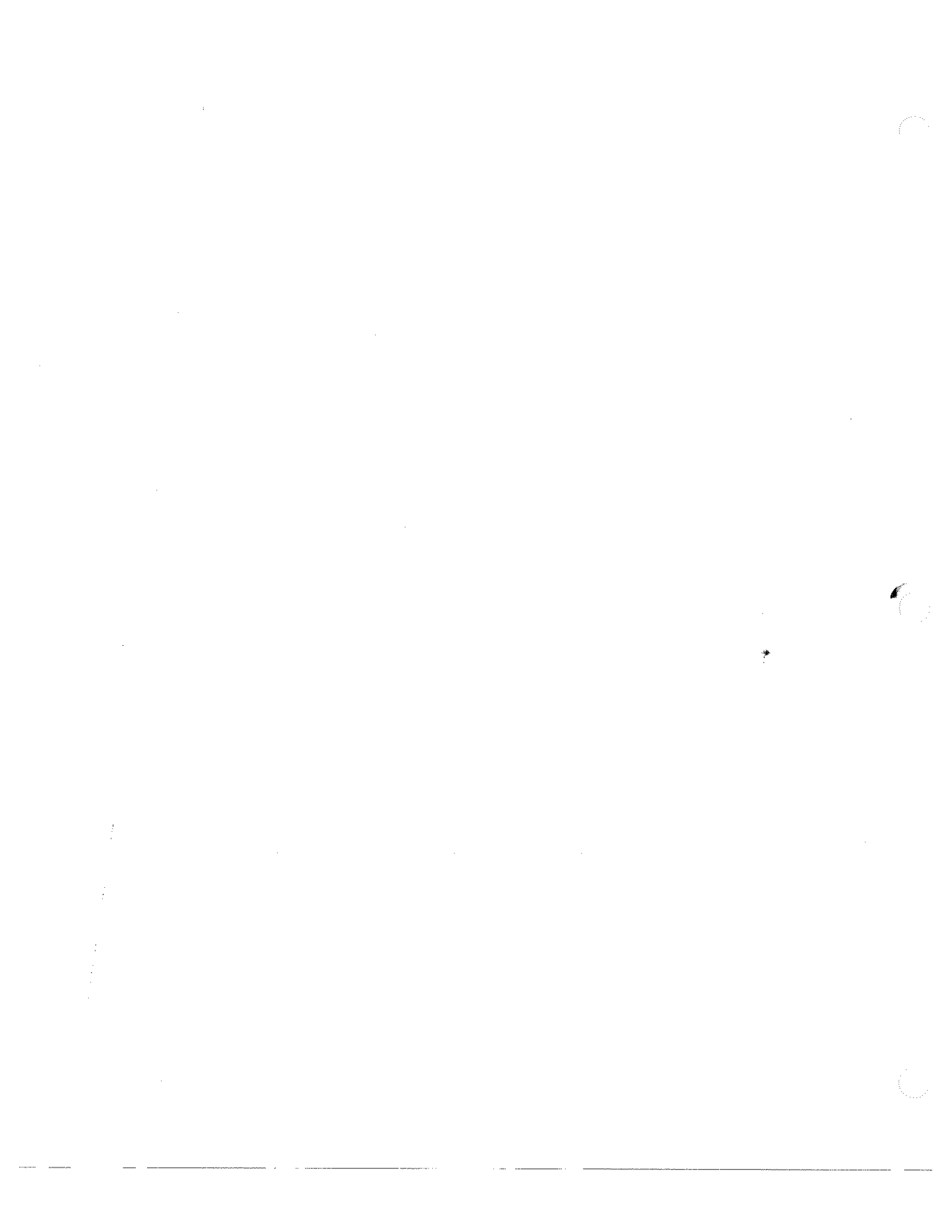

Instrument State Function Block

Introduction

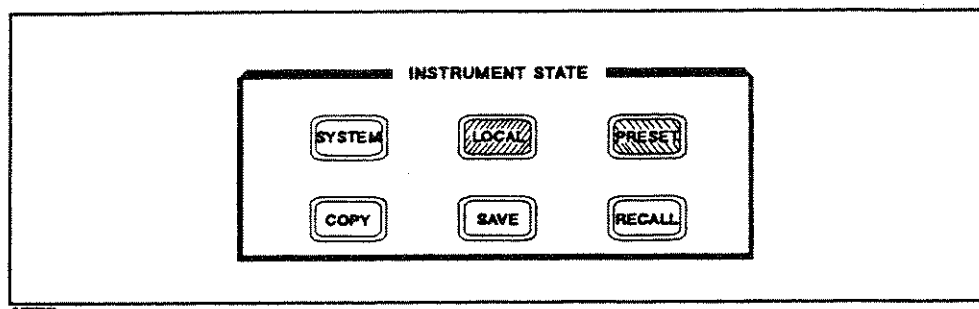

Figure 12-1. Instrument State Function Block

The instrument state function block keys and associated menus provide control of channel-independent system functions. These include controller modes, instrument addresses, real time clock, BIN sorting, limit lines, and limit testing, Instrument BASIC, plotting or printing, saving instrument states and trace data on a built-in disk and a RAM disk memory.

Instrument State Functions and Where They Are Described

Functions accessible in the instrument state function block are described in several different chapters of this Reference, and in other manuals.

Table 12-1 lists each function and where it is discussed. Unless otherwise noted, all references are in this Reference and are marked with the acronym "REF".

Table 12-1. Instrument State Function Descriptions

Instrument State Key	Function	Chapter or Manual
(SYSTEM)	Instrument BASIC Clock BIN Sorting Limit Lines and Limit Testing Service Menu	<i>HP Instrument BASIC Manual Set</i> Using HP Instrument BASIC with the HP 87510A This Chapter This Chapter This Chapter <i>Maintenance Manual</i>
(COPY)	All Features - including printing and plotting	Chapter 10, REF
(SAVE)	All Features - including saving instrument states and saving to built-in disk and RAM disk memory.	Chapter 14, REF
(RECALL)	All Features - including recall of instrument state and data from built-in disk drive and RAM disk memory.	Chapter 14, REF
(LOCAL)	All features - including HP-IB and address menus.	This Chapter
(PRESET)	Preset State	Appendix B, REF

(LOCAL) Key

(LOCAL) key leads to the following menus:

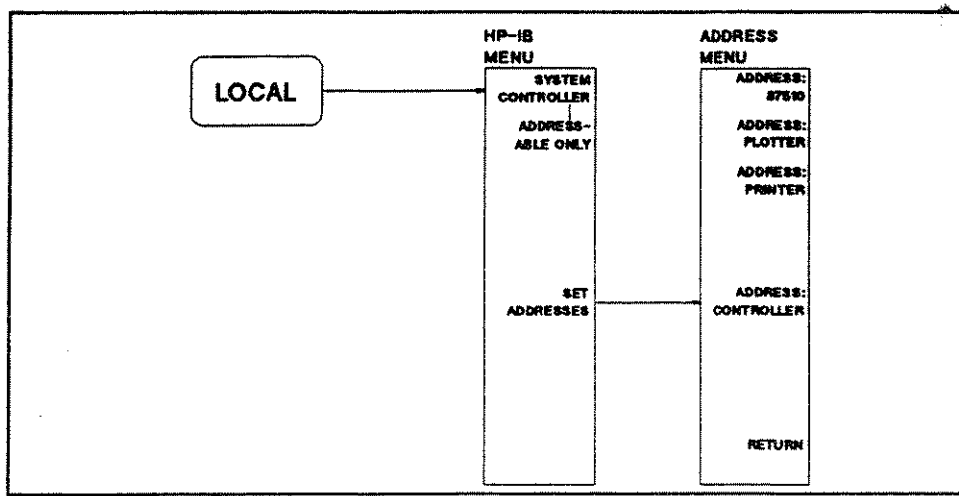

Figure 12-2. Softkey Menus Accessed from the (LOCAL) Key

This key performs the following functions:

- Returns front panel control to the user. The instrument ignores all front panel keys (except the local key) when under the control of an external computer. The instrument is in “local mode” when the user has front panel control. The instrument is in the “remote mode” when an external computer controls the instrument.

- Gives access to the HP-IB menu, which sets the controller mode, and to the address menu, where the HP-IB addresses of peripheral devices are entered. The controller mode determines which device controls the HP-IB bus, the instrument or computer. Only one of them can control the bus at a time.

Local Lockout

Local lockout is a remote (computer generated) command that disables the **LOCAL** key, making it impossible to interfere with the instrument (except for the Power Switch) while it is under computer control.

HP-IB Menu

The analyzer is factory-equipped with a remote programming interface using the Hewlett-Packard Interface Bus (HP-IB). This enables communication between the analyzer and a controlling computer as well as other peripheral devices. This menu indicates the present HP-IB controller mode of the analyzer. Two HP-IB modes are possible: system controller and addressable only.

Preset and cycling the power does not affect the selected controller mode.

Information on usable peripherals is provided in Chapter 2.

System Controller Mode

In the system controller mode, the analyzer itself can use HP-IB to control peripherals usable with the HP 87510A, without the use of an external computer. For example, the analyzer can output measurement results directly to a printer or plotter.

Addressable Mode

This is the mode of operation most often used. In this mode, a computer can take control of and communicate with the analyzer and other peripherals on the bus. The computer can send commands or instructions to and receive data from the analyzer. All of the capabilities available from the analyzer front panel can be used in this operation mode. Exceptions are some special functions such as internal tests.

Information on HP-IB operation is provided in Chapter 15 and in the *HP-IB Programming Manual*.

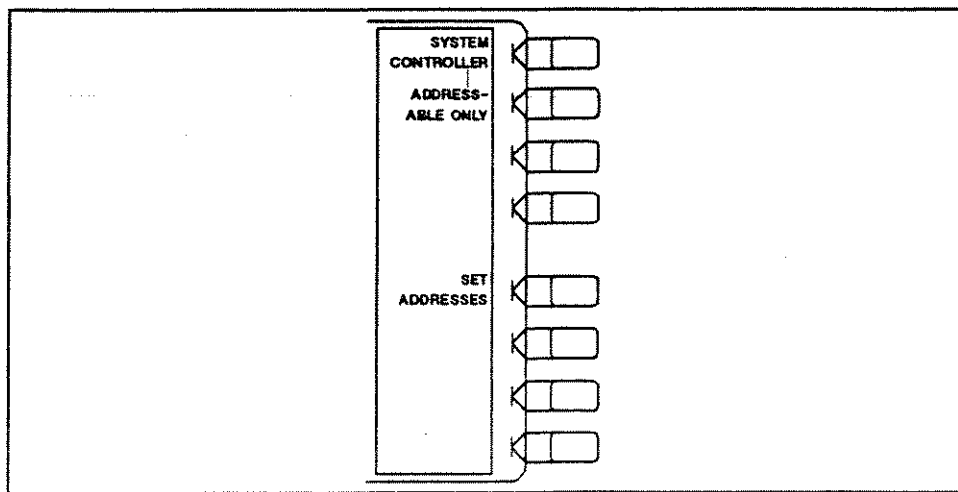

Figure 12-3. HP-IB Menu

SYSTEM CONTROLLER is the mode used when peripheral devices are to be used and there is no external controller. See the description above.

The system controller mode can be used without knowledge of HP-IB programming. However, the HP-IB address must be entered for each peripheral device.

This mode can only be selected manually from the analyzer's front panel, and can be used only if no active system controller is connected to the system through HP-IB. If you try to set system controller mode when another system controller is present, the message "CAUTION: CAN'T CHANGE - ANOTHER CONTROLLER ON BUS" is displayed.

ADDRESSABLE ONLY is the mode used when an external controller controls peripheral devices or the analyzer. This mode is also used when the external computer passes control of the bus to the analyzer.

SET ADDRESSES goes to the address menu, which sets the HP-IB address of the analyzer, and to display and modify the addresses of peripheral devices in the system.

Address Menu

In communications through the Hewlett-Packard Interface Bus (HP-IB), each instrument on the bus is identified by an HP-IB address. This decimal-based address code must be different for each instrument on the bus.

This menu sets the HP-IB address of the analyzer. It also sets the HP-IB addresses the analyzer will use when talking to each peripheral.

Most of the HP-IB addresses are set at the factory and need not be modified for normal system operation. The standard factory-set addresses for instruments that may be part of the system are as follows:

Table 12-2. Default HP-IB Addresses

Instrument	HP-IB Address (decimal)
Analyzer	17
Plotter	05
Printer	01
Controller	21

The address displayed in this menu for each peripheral device must match the address set on the device itself. If the addresses do not match, they can be matched in one of two ways. Either the address set in the analyzer can be changed using the entry controls; or the address of the device can be changed using instructions provided in its manual. The analyzer's HP-IB address is changed through the keyboard controls, there is no physical HP-IB switch.

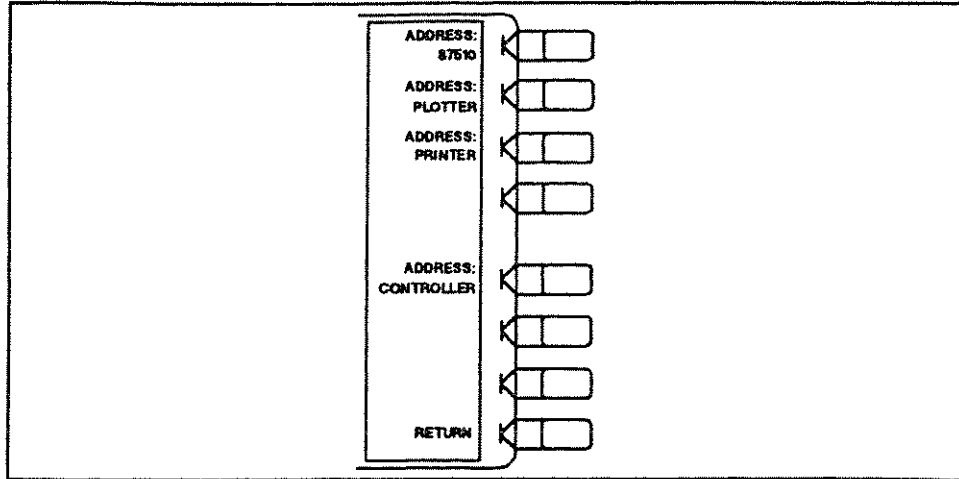

Figure 12-4. Address Menu

ADDRESS: 87510 sets the HP-IB address of the analyzer, using the entry controls. There is no physical address switch to set in the analyzer.

ADDRESS: PLOTTER (ADDRPLOT) sets the HP-IB address the analyzer will use to communicate with the plotter.

ADDRESS: PRINTER (ADDRPRIN) sets the HP-IB address the analyzer will use to communicate with the printer.

ADDRESS: CONTROLLER (ADDRCONT) sets the HP-IB address the analyzer will use to communicate with the external controller.

RETURN goes back to the HP-IB menu. *

SYSTEM Key

The HP-IB programming command is shown in parenthesis following the key or softkey. This key presents the system menu.

System Menu

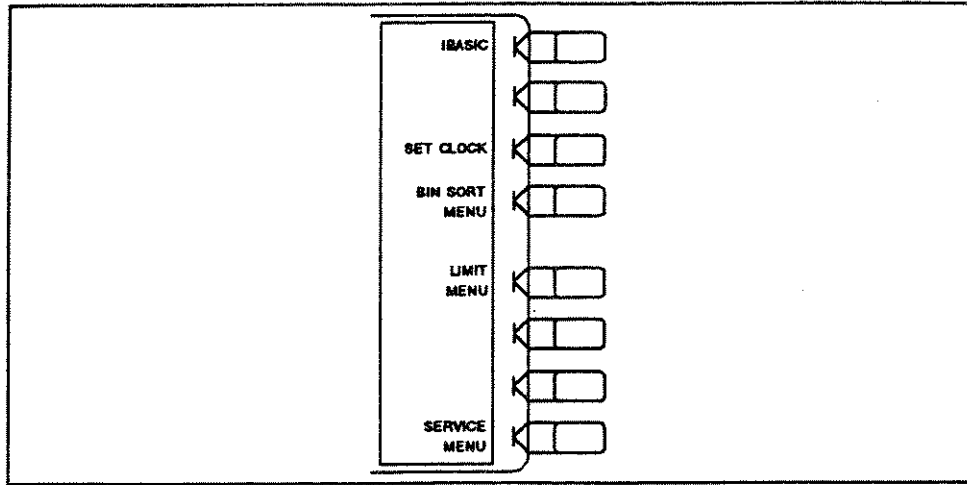

Figure 12-5. System Menu

IBASIC leads to a series of menus used to operate Instrument BASIC. See "Instrument BASIC" in this chapter.

SET CLOCK leads to a series of menus as shown in Figure 12-7, which sets an internal clock. See "Real Time Clock" in this chapter.

BIN SORT MENU leads to a series of menus as shown in Figure 12-23, which defines BINs and specifications with which to compare a test device. See "BIN Sort Function".

LIMIT MENU leads to a series of menus as shown in Figure 12-15, which defines limits or specifications with which to compare a test device. See "Limit Line and Limit Testing".

SERVICE MENU leads to a series of service menus described in detail in the *Maintenance Manual*.

Instrument BASIC

HP Instrument BASIC gives the analyzer programmability without using an external controller. The softkeys shown in the Figure 12-6 allows performing basic operations of HP Instrument BASIC. When you are developing more complex programs, the HP-HIL key board (Option 002) must be used. HP Instrument BASIC is subset of HP BASIC and allows all of the analyzer's measurement capabilities and any other HP-IB compatible instrument to be programmed. For more information about Instrument BASIC, see *Using HP Instrument BASIC with the HP 87510A* in this manual, and the *HP Instrument BASIC Users Handbook* furnished with Option 002.

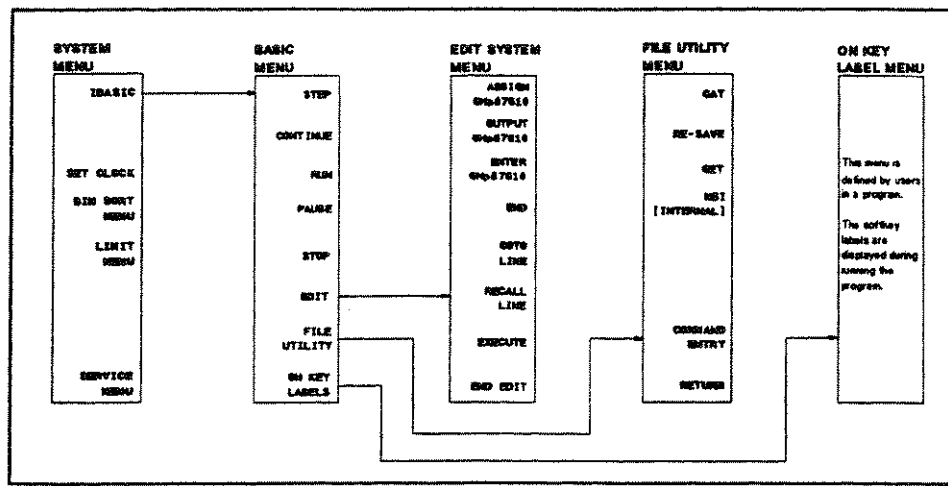

Figure 12-6. Softkey Menus Accessed from the **IBASIC** Softkey

BASIC Menu

Step allows you to execute one program line at a time. This is particularly useful for debugging.

Continue resumes program execution from the point where it was paused.

Run starts a program from its beginning.

Pause pauses program execution after the current program line has executed.

Stop stops program execution after the current line. To restart the program, press **Run**.

Edit enters into the EDIT mode.

FILE UTILITY leads to File Utility menu.

ON KEY LABEL leads to a softkey menu defined during program execution, if the softkey menu has been defined.

Edit System Menu

In the edit mode, the key sequence pressing **SYSTEM** and **IBASIC** leads to the softkey menu to produce the character which are the BASIC commands and editor control commands most often used in developing and running BASIC programs.

ASSIGN @Hp87510 produces the command "ASSIGN @Hp87510 TO 800" at the cursor's current position.

OUTPUT @Hp87510 produces the command "OUTPUT @Hp87510;"" at the cursor's current position.

ENTER @Hp87510 produces the command "ENTER @Hp87510;" at the cursor's current position.

END produces the command "END".

GOTO LINE allows you to move the cursor to any line number or label, after pressing **GOTO LINE**, type a line number or a label and then press **Return**, the cursor moves to the specified line or label.

COMMAND ENTRY leads to the Command Entry menu. (See "Command Entry Menu".)

END EDIT exits the edit mode.

ON KEY LABEL Menu

Softkeys in this menu are defined in a program, and the softkeys are labeled during program execution. For more information on using this feature, see "ON KEY" in Chapter 2 of the *HP Instrument BASIC Language Reference* furnished with Option 002.

File Utility Menu

CAT produces the command "CAT". CAT lists the contents of a mass storage directory.

RE-SAVE produces the command "RE-SAVE"". RE-SAVE creates a specified ASCII file if it does not exist; otherwise, it re-writes a specified ASCII file by copying program lines as strings into that file.

GET produces the command "GET"". GET reads the specified ASCII file and attempts to store the strings into memory as program lines.

MSI [DISK] selects between the flexible disk drive and the RAM disk memory as the storage device used from Instrument BASIC programs. This setting is independent of the setting of the **STOR DEV** under the **SAVE** key.

COMMAND ENTRY leads to the Command entry menu, which allows you to execute Instrument BASIC commands from the front panel keys.

RETURN goes back to the BASIC menu.

Command Entry Menu

HP 87510A Instrument BASIC allows you to enter and execute statements from the front panel keys, if the external HP-HIL keyboard is not connected.

The Command Entry menu is displayed on the softkey menu area, and the active entry area displays the letters, the digits 0 through 9, and some special characters including mathematical symbols. Three sets of letters can be scrolled using the step keys, \uparrow and \downarrow . To enter a statement, press the step keys for the desired letter set, rotate the knob until the arrow "↑" points at the first letter, then press **SELECT LETTER**. Repeat this until the complete statement is entered, then press **DONE** to execute the statement.

SELECT LETTER selects the character pointed to by "↑".

SPACE inserts a space.

BACK SPACE deletes the last character entered.

ERASE TITLE deletes all characters entered.

DONE terminates command entry, and executes the command you entered.

CANCEL cancels command entry and returns to the BASIC menu.

Real Time Clock

This analyzer provides a real time clock to print time and date on the hard copy by Copy function.

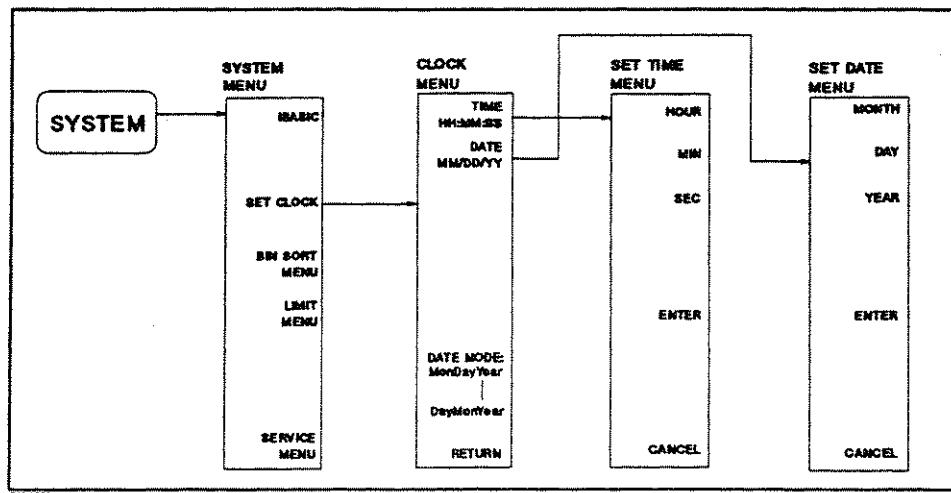

Figure 12-7. Softkey Menus Accessed from the **SET CLOCK** Softkey

Clock Menu

This menu is used to print the current time and date. When the analyzer prints or plots the data, the current time and date is printed or plotted before the information on the screen, if **COPY TIME** under the **(COPY)** key is turned on.

TIME HH:MM:SS (SETCTIME) displays the current time when pressed. To adjust the time, see "Set Time Menu".

DATE MM/DD/YY (SETCDATE) displays the current date when pressed. To adjust the date, see "Set Date Menu".

DATE MODE: MonDayYear (MONDYEAR) changes the displayed date to the "month:day:year" format.

DayMonYear (DAYMYEAR) changes the displayed date to the "day:month:year" format.

RETURN returns to the system menu.

Set Time Menu

This menu is used to set the internal clock.

HOOR enables changing the hour setting using the knob or the numeric entry keys. After you change the hour setting, press **ENTER** to restart the clock.

MIN enables changing the minute setting using the knob or the numeric entry keys. After you change the minute setting, press **ENTER** to restart the clock.

SEC enables changing the second setting using the knob or the numeric entry keys. After you change the second setting, press **ENTER** to restart the clock.

ENTER restarts the internal clock.

CANCEL returns to the clock menu. Pressing this key will not affect the internal clock setting.

Set Date Menu

MONTH enables changing the month setting using the knob or the numeric entry keys. After you change the month setting, press **ENTER** to restart the clock.

DAY enables changing the day setting using the knob or the numeric entry keys. After you change the day setting, press **ENTER** to restart the clock.

YEAR enables changing the year setting using the knob or the numeric entry keys. After you change the year setting, press **ENTER** to restart the clock.

ENTER restarts the internal clock.

CANCEL returns to the clock menu. Pressing this key will not affect the internal clock setting.

BIN Sort Function

The BIN sort function specifies multiple ranges (BINs), which define both upper and lower limits for various characteristics of a sample for comparison checks between the BIN limits and measurements (BIN sort testing). BIN sort testing is implemented for each measurement point.

Up to 16 BINs may be assigned to each channel (a total of 32 BINs may be specified for both channels). If different BINs cover the same range, the range of the BIN having the lowest number is given priority.

The upper and lower limits of a specified BIN can be displayed as BIN lines overlaying the measurement trace on the screen.

The result of BIN sort testing for each measurement point is output to the I/O port. The bit pattern output to the I/O port can be defined for each BIN. If a measurement is not within all of the BIN limits, it is considered to be in the out-of-BIN range and the bit pattern defined for the out-of-BIN range is output to the I/O port.

A bit of the HP-IB Event Status register B (ESB) can be set when measurement result is within the BIN specified. Setting bit of ESB causes an interrupt during execution of a BASIC program and the program can detect when a measurement result is within the BIN specified.

Either port A or B can be selected as a bit pattern output I/O port. For more information on I/O ports, see Appendix C "I/O Ports."

Note

Option 005, Parallel I/O Mode A (8 bit I/O port) can not be used for an output port.



All BIN sort functions can be specified for each channel.

Example of Using the BIN Sort Function

An example of using the BIN sort function is given here. Figure Figure 12-8 shows an example of sorting ranges by deviation from a reference point. In this example, the upper and lower limits of BIN1 are set to +10 dB and -10 dB, those of BIN2 are set to +20 dB and -20 dB, and those of BIN3 are set to +30 dB and -30 dB respectively. When different BINs cover the same range, the range of the BIN having the lowest number is given priority. Therefore, actual ranges of BIN2 and BIN3 can be sorted by deviation from the central value as shown in Figure 12-8. Setting the span to 0, specifying different measurement conditions for each measurement point, or exchanging samples allows you to sort measurements or multiple samples.

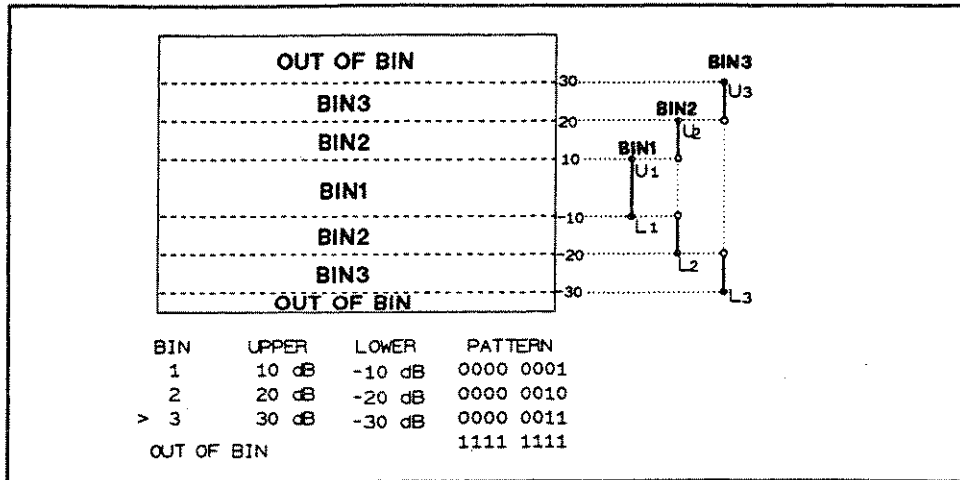

Figure 12-8. Example of Sorting by Deviation

Figure 12-9 shows an example of specifying slightly complicated BINs. Since BIN1 does not overlap any of the other BIN ranges, the ranges between BIN1 and other BINs become out-of-BIN ranges. On the other hand, BIN2 and BIN3 do overlap. Since the range of the BIN having the lowest number is given priority, BIN3 actually ranges from -30 dB to -50 dB.

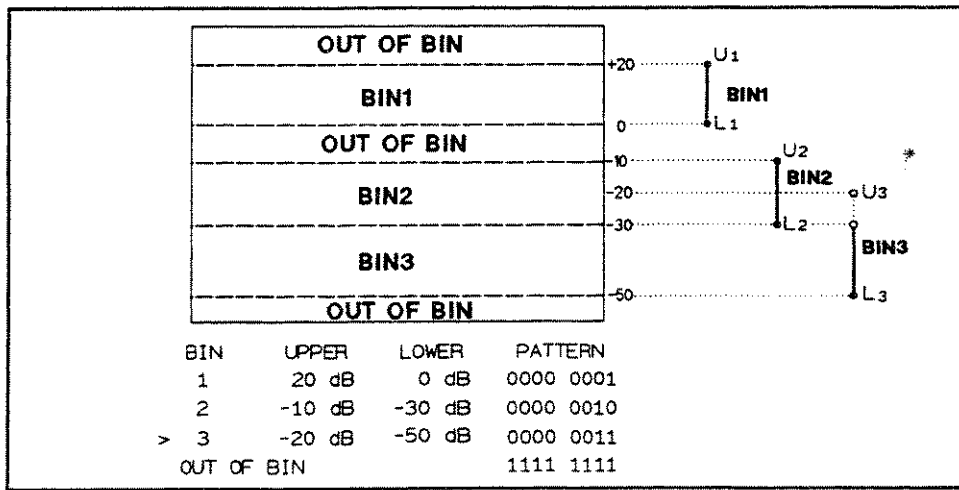

Figure 12-9. A Complex Example

BIN Sort Softkey Menu

The **SYSTEM** softkey provides access to the BIN sort function menu. Figure 12-10 shows this menu.

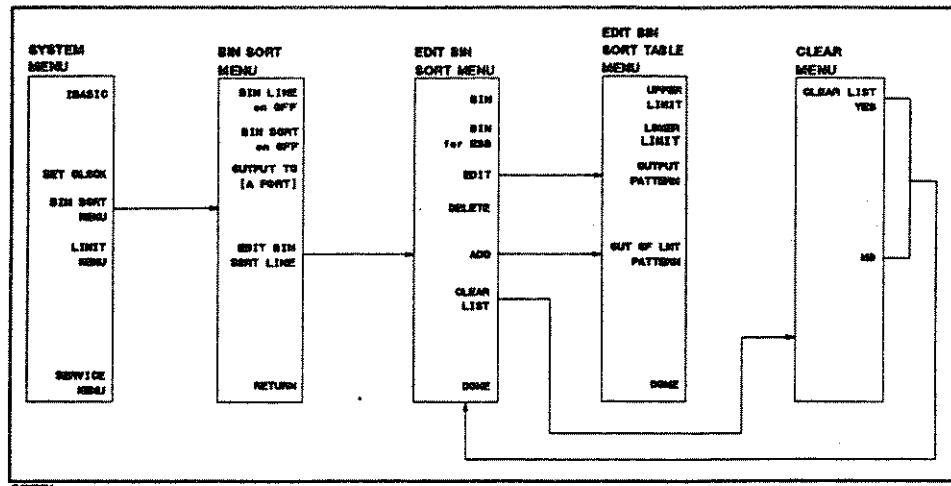

Figure 12-10. Softkey Menu Accessed from the **BIN SORT MENU** Softkey

BIN Sort Menu

This menu is used to turn BIN lines ON or OFF, turn BIN sort testing ON or OFF, or select an output port. It also leads to the BIN sort edit menu.

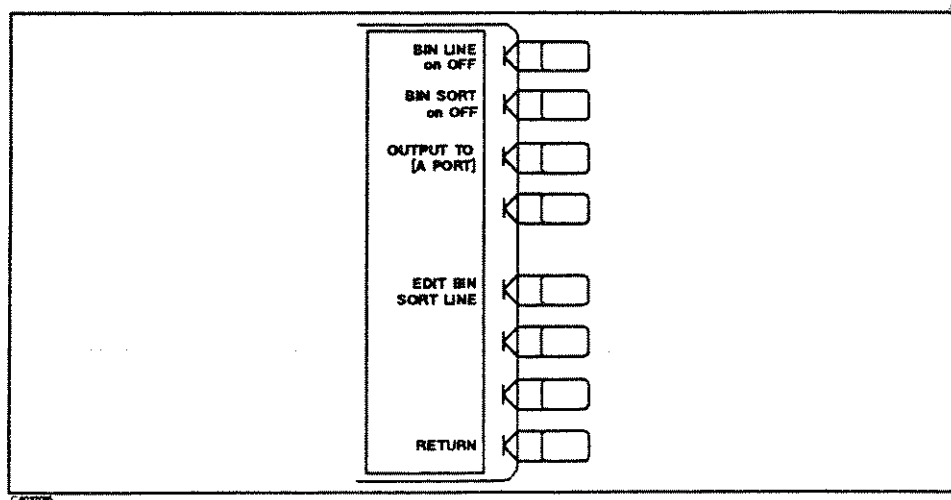

Figure 12-11. BIN Sort Menu

BIN LINE on OFF (BINSLINE) turns BIN lines ON or OFF.

BIN SORT on OFF (BINS) turns BIN sort testing ON or OFF. To define upper and lower limits of a BIN or an I/O pattern, use the **EDIT BIN SORT LINE** softkey described below.

OUTPUT TO B (BINOA for **A PORT**, BINOB for **B PORT**) selects an I/O port to which the BIN sort testing result is to be output. Either I/O port A or B may be selected. The length of the bit pattern that can be output to the I/O port is 8 bits.

EDIT BIN SORT LINE (EDITBINL) displays the BIN setting (BIN sort table) on the lower half of the display. It leads to the BIN sort edit menu, used to specify or modify BINs.

RETURN returns to the system menu.

Edit BIN Sort Menu

This menu is used to add a new BIN or select the BIN to be modified. Use the **ADD** or **EDIT** softkey in this menu to call the BIN sort table edit menu, which specifies BIN's upper and lower limits and the output bit pattern.

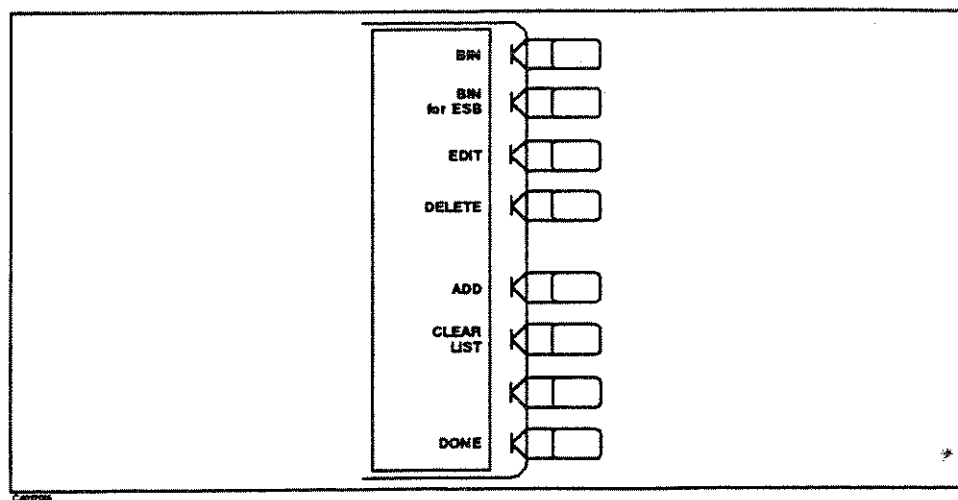

Figure 12-12. Edit BIN Sort Menu

BIN (BINSEDI) selects the BIN to be edited. Generally, up to seven BINs may be displayed. Using the entry block controls, move the pointer ">" next to the BIN to be edited. The indicated BIN can then be modified or deleted. If "EMPTY" is displayed, specify a new BIN using the **ADD** or **EDIT** softkey.

BIN for ESB (BINESB) selects the BIN number to set a bit of the event status register B (ESB) when a result of testing is in the BIN selected by this key. When "0" is set as the BIN number, ESB is set when a result is OUT OF BIN. When "17" is set, ESB is not set.

EDIT displays the BIN sort table edit menu, which defines or changes the upper and lower limits of the specified BIN and the output pattern. When the BIN table is empty, a default BIN is displayed.

DELETE (BINSDEL) deletes the BIN indicated by the pointer ">".

ADD (BINSADD) displays the BIN sort table edit menu to add a new BIN. The initial value of the added BIN is the same as that of the BIN indicated by the pointer. If the BIN table is empty, a default BIN is displayed.

CLEAR LIST leads to the clear menu, which clears all BINs in the BIN sort table.

DONE (BINSDON) returns to the BIN sort menu.

Edit BIN Sort Table Menu

This menu is used to set the upper and lower limits and output bit pattern of each BIN and the bit pattern output for measurements in the out-of-BIN range. The BIN to be edited is selected in the BIN sort edit menu.

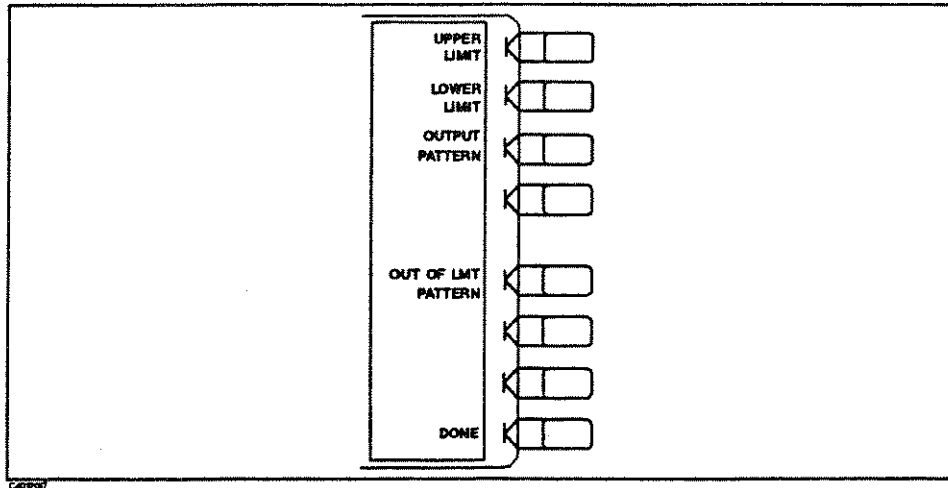

Figure 12-13. Edit BIN Sort Table Menu

UPPER LIMIT (BINU) sets the upper limit of the BIN. If the upper limit is specified, the lower limit must also be specified. If the upper limit is not required, set an extremely large value; for example, 500 dB.

LOWER LIMIT (BINL) sets the lower limit of the BIN. If the lower limit is specified, the upper limit must also be specified. If the lower limit is not required, set an extremely small value; for example, -500 dB.

OUTPUT PATTERN (BINP) sets the bit pattern to be output from the I/O port when the measurement obtained through BIN sort testing is included in this BIN. The bit pattern is displayed in binary numbers on the edit screen.

OUT OF LMT PATTERN (BIN0) sets the bit pattern to be output from the I/O port when the measurement obtained through BIN sort testing is outside all BINs.

DONE returns to the BIN sort edit menu.

Clear Menu

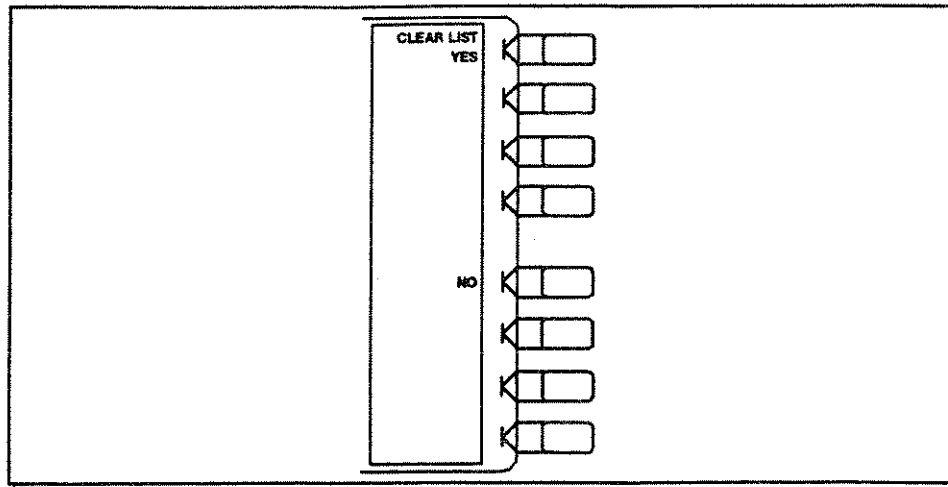

Figure 12-14. Clear Menu

CLEAR LIST YES (BINCEL) clears all BIN settings and returns to the BIN edit menu.

NO returns to the BIN edit menu without clearing BIN settings.

Limit Line and Limit Testing

These are lines drawn on the display to represent upper and lower limits or device specifications with which to compare the device under test. Limits are defined by specifying several segments, where each segment is a portion of the stimulus span. Each limit segment has an upper and a lower starting limit value.

Limits can be defined independently for the two channels, up to 18 segments for each channel (a total of 36 for both channels). These can be in any combination of the two limit types.

Limit testing compares the measured data with the defined limits, and provides pass or fail information for each measurement point. The results are indicated when sweep ends or each data point is measured. An out-of-limit test condition is indicated in the following ways:

- Displaying a FAIL message on the screen
- Emitting a beep
- Displaying an asterisk in tabular listings of data
- Writing a bit into HP-IB event status register B
- Writing LOW-status of PASS/FAIL signal line of the I/O port on the analyzer rear panel. See Appendix C and D.

Limits are entered in tabular form. Limit lines and limit testing can be either ON or OFF while limits are defined. As new limits are entered, the tabular columns on the display are updated, and the limit lines (if on) are modified to the new definitions. The complete limit set can be offset in either stimulus or amplitude value.

An example of a measurement using limit lines and limit testing is provided at the end of this section (See "Using Limit Line Testing").

The series of menus for defining limits are accessed using the **SYSTEM** key. These menus are illustrated in Figure 12-15.

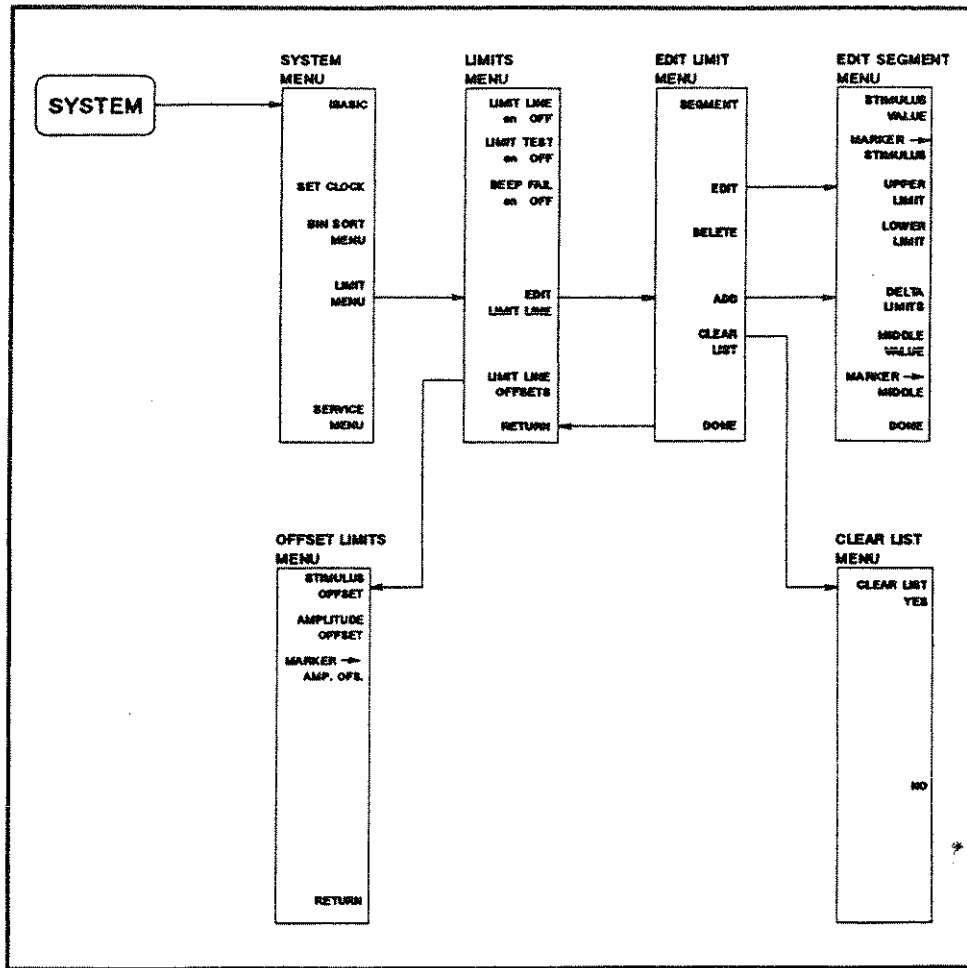

Figure 12-15. Softkey Menus Access from the **LIMIT MENU** softkey.

How Limit Lines are Entered

Before limit lines can be explained, the concept of “segments” must be understood. A segment is the node of two limit lines. See Figure 12-16.

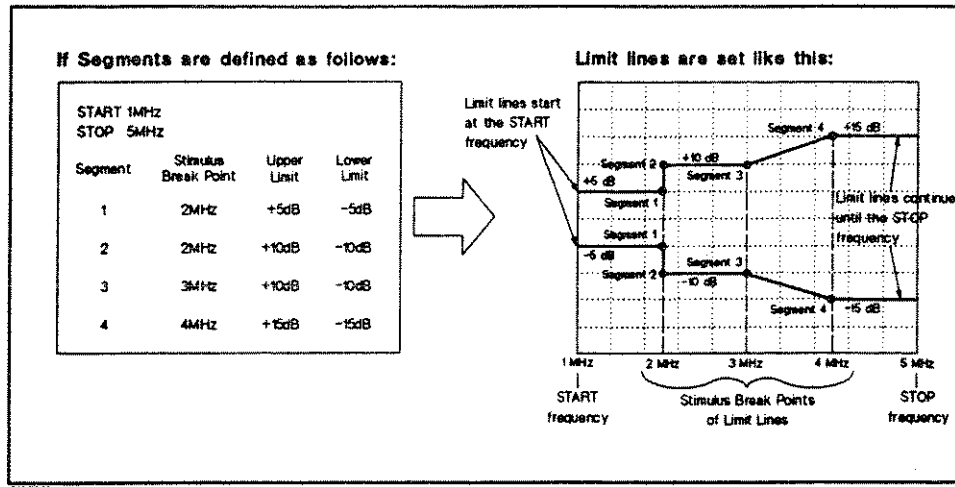

Figure 12-16. The Concept of Segments as a Point between Two Sets of Limit Lines

As you can see in Figure 12-16, segments are distinct points that define where limit lines begin or end. Limit lines span the distance between segments and represent the upper and lower test limits. Figure 12-16 shows another important aspect of limit lines: The most left hand side of set of limit lines will continue from the minimum stimulus value (START), and the most right hand side of set of limit lines will continue until the maximum stimulus value (STOP).

A segment is placed at a specific stimulus value (a single frequency for example). The first segment defines the limit line value from the start frequency to the frequency entered for the first segment. Once its stimulus value is entered, the upper and lower test limit, +5 dB and -5 dB for example, needs to be supplied. The limit line will start at the start frequency and the upper and lower limits set for the first segment and will extend to the frequency and limits values set for the first segment.

Defining a second segment defines where the first set of limit lines ends. This process is repeated to create different sets of limit lines, each having new upper and lower limits. Up to 18 segments can be entered.

Limits can be defined independently for the two channels.

The example in Figure 12-16 shows a combination of limit lines which change instantly and gradually.

Segment 1 is at 2 MHz has upper and lower limits of +5 and -5 dB, respectively. Notice that the upper and lower limit lines start at the START frequency (1 MHz) and end at segment 1.

Segment 2 is also set to at 2 MHz with different upper and lower limits of +10 dB and -10 dB, the limit line value's change is discontinuous from segment 1 to segment 2, creating a step in the limit line.

Segment 3 is at 3 MHz with the same limit value as segment 2 to obtain flat limit lines.

Segment 4 is at 4 MHz with the upper and lower limit values of +15 dB and -15 dB, the limit values change gradually from segment 3 to segment 4. Notice that the upper and lower limit lines then extend from segment 4 to the STOP frequency (5 MHz) while maintaining the same upper and lower limits set for segment 4.

Note

Limit lines cannot be broken along the stimulus axis, so when limit lines are needed partially along the stimulus axis, the non-limit-testing portion must be entered also. Set the non-limit-testing portion by forcing the upper and lower limit values out of range, +500 dB and -500 dB for example.

Both an upper limit and a lower limit (or delta limits) must be defined: if only one limit is required for a particular measurement, force the other limit out of range, +500 dB or -500 dB for example.

Turning Limit Lines Limit Testing On and Off

Limit lines and limit testing features are **OFF** unless explicitly turned **ON** by the user. After entering the limit line data, you may turn **ON** the limit line feature and optionally the limit testing features. Turning these features **OFF** has no effect on the entered limit line data.

Segments Entering Order Needs Notice

Generally, the segments do not have to be entered in any particular order: the analyzer automatically sorts them and lists them on the display in increasing order of stimulus value.

One exception is when two segments have the same stimulus value as described in Figure 12-16. If the same stimulus values exist, the analyzer draws the limit lines according to entered segment order. For example in Figure 12-16, segment 1 should be entered in advance of segment 2.

Saving the Limit Line Table

Limit line data is lost if **PRESET** is pressed or if the line switch is turned **OFF**. However, the **SAVE** and **RECALL** keys can save limit line data along with all other current analyzer settings. Limit line table information can be saved in a disk file.

Offsetting the Stimulus or Amplitude of the Limit Lines

All limit line entries can be offset in either stimulus or amplitude values. An offset will affect all segments simultaneously.

Supported Display Formats

Limit *lines* are displayed only in Cartesian format. In polar format, limit testing at a single value *is* available: the value tested depends on the marker mode and is the magnitude or the first value in a complex pair. The message "NO LIMIT LINES DISPLAYED" is shown on the display using the polar format.

Use a Sufficient Number of Points or Errors May Occur

Limits are checked only at the actual measured data points. If you do not select a sufficient number of points, it is possible for a device to be out of specification without a limit test failure indication.

To avoid this, be sure to specify enough limit points. In addition, if specific stimulus points must be checked, use the list sweep features described in Chapter 8 so that the actual measured data points are checked, exactly.

Displaying, Printing, or Plotting Limit Test Data

The "list values" feature in the copy menu prints or displays a table of each measured stimulus value. The table includes limit line and/or limit test information (if these functions are turned ON). If limit testing is ON, an asterisk "*" is listed next to any measured value that is out of limits.

If the limit lines are ON, and other listed data allows sufficient space, the following will also be displayed:

- Upper limit and lower limit
- The margin by which the device passes or fails the nearest limit

For more information about the list values feature, see "Copy More Menu" in Chapter 13.

Results of Plotting or Printing the Display with Limit Lines ON

If the limit lines are ON, they are included when you print or plot the display. If limit testing is ON, the PASS or FAIL message is included as well.

Limit Menu

This menu independently toggles the limit lines, limit testing, and limit fail beeper. It also leads to the menus that define and modify the limits.

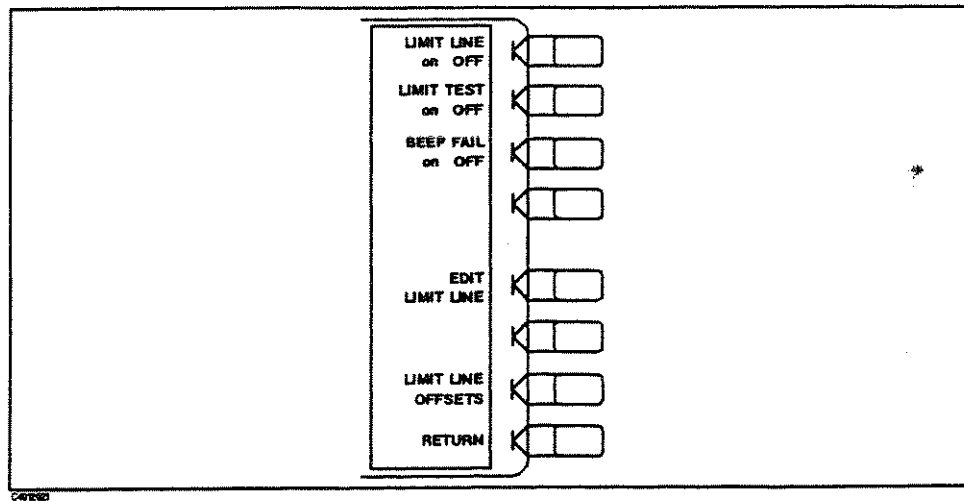

Figure 12-17. Limits Menu

LIMIT LINE on OFF (LIMILINEON, LIMILINEOFF) turns limit lines ON or OFF. To define limits, use the **EDIT LIMIT LINE** softkey described below. If limits have been defined and limit lines are turned ON, the limit lines are shown on the display for visual comparison of the measured data in all Cartesian formats.

If limit lines are ON, they can be saved on the disk with an instrument state. In a listing of values from the copy more menu with limit lines ON and limit test ON, the upper and lower limits are listed together with the pass or fail margins, as long as other listed data allows sufficient space.

LIMIT TEST on OFF (LIMITESTON, LIMITESTOFF) turns limit testing ON or OFF. When limit testing is ON, the data is compared with the defined limits at each measurement point. Limit

tests occur at the end of each sweep, whenever the data is updated and when limit testing is first turned ON.

Limit testing is available for both magnitude and phase values in Cartesian formats. In polar format, the value tested depends on the marker mode and is the magnitude or the first value in a complex pair. The message "NO LIMIT LINES DISPLAYED" is displayed in polar format if limit lines are turned ON.

Five different ways of indications of pass or fail status are provided when limit testing is ON.

- A PASS or FAIL message is displayed at the right of the display.
- The limit fail beeper sounds if it is turned ON.
- In a listing of values using the copy menu, an asterisk * is shown next to any measured point that is out of limits.
- A bit is set in the HP-IB status byte.
- The PASS/FAIL line in the I/O port on the analyzer rear panel goes to a TTL LOW logic level.

BEEP FAIL on OFF (BEEPFAILON, BEEPFAILOFF) turns the limit fail beeper ON or OFF.

When limit testing is ON and the fail beeper is ON, a beep is emitted each time a limit test is performed and a failure is detected. The limit fail beeper is independent of the warning beeper and the operation complete beeper, both of which are described in "Display More Menu" in Chapter 9.

LMT TST ON [] (LIMIOSEND, LIMIOPOIN) toggles when the pass or fail status is indicated, either the end of sweep or the end of measurement at each measurement point. When **[SWP END]** is displayed, the status is indicated when sweep ends. When **[POINT]** is displayed, the status is indicated when the measurement at each point ends.

EDIT LIMIT LINE (EDITLIML) displays a table of limit segments on the lower half of the display. The edit limits menu is presented so that limits can be defined or changed.

LIMIT LINE OFFSETS leads to the offset limits menu, which offsets the complete limit set in either stimulus or amplitude value.

RETURN goes back to the system menu.

Edit Limits Menu

This menu is used to add new segments or select existing segments to be edited. The **ADD** and **EDIT** softkeys in this menu provides the edit segment menu (described later), which lets you select stimulus and limit values.

Note



Before editing the limit lines, it is convenient to turn the limit lines ON using the **LIMIT LINE on OFF** softkey. This displays the limit lines while you are editing.

A table of limit values appears on the display when this menu is provided. A thorough description of how segments work is described at the beginning of this section. Read that information before continuing.

For each segment, the table lists the segment number, stimulus value, upper limit, and lower limit. Limit values can be entered as upper and lower limits or as delta limits with a midpoint values.

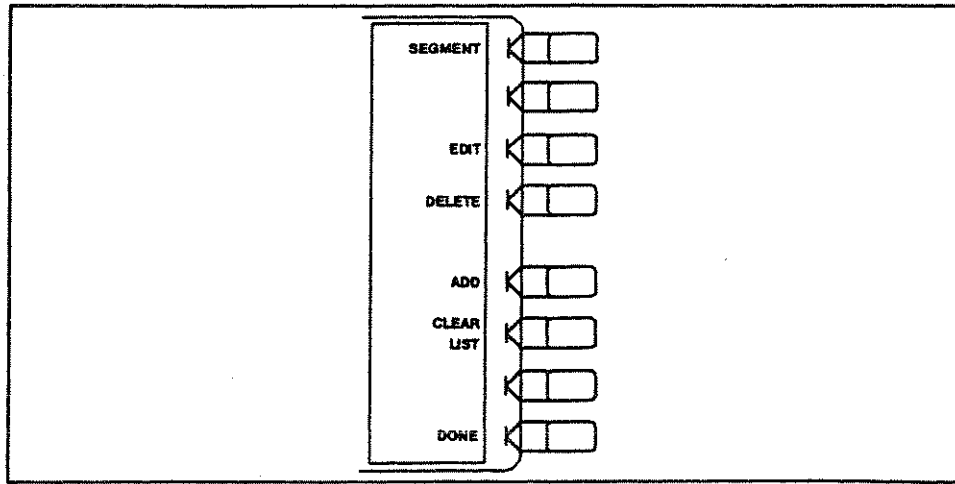

Figure 12-18. Edit Limits Menu

SEGMENT specifies which limit segment in the table is to be edited. A maximum of eight sets of segment values are displayed at one time, and the list can be scrolled up or down to show other segment entries. Use the entry block controls to move the pointer ">" next to the required segment number. The indicated segment can then be edited or deleted. If the table of limits is designated "EMPTY", new segments can be added using the **ADD** or **EDIT** softkey.

EDIT (LIMSEDI) displays the edit segment menu, which defines or modifies the stimulus value and limit values of a specified segment. If the table was empty, a default segment is displayed.

DELETE (LIMSDEL) deletes the segment indicated by the pointer ">".

ADD (LIMSADD) displays the edit segment menu and adds a new segment to the end of the list. The new segment is initially a duplicate of the segment indicated by the pointer ">" and selected with the **SEGMENT** softkey. If the table was empty, a default segment is displayed.

CLEAR LIST leads to the clear list menu, which clears all of the segments in the limit test.

DONE (LIMEDONE) sorts the limit segments and displays them on the display in increasing order of stimulus values. The limits menu is returned to the screen.

Edit Segment Menu

This menu is used to set the value of the individual limit segments. The segment to be modified, or a default segment, is selected in the edit limits menu.

The stimulus value can be set with the controls in the entry block or with a marker (the marker is turned ON automatically when this menu is presented). The limit values can be defined as upper and lower limits, or as delta limits and midpoint values.

As new values are entered, the tabular listing of limit values is updated.

As described in the beginning of this section, generally segments do not have to be listed in any particular order: the analyzer sorts them automatically in increasing order of start stimulus value when the **DONE** key in the edit limits menu is pressed. However, the easiest way to enter a set of limits is to start with the lowest stimulus value and define the segments from left to right of the display, with limit lines turned ON as a visual check.

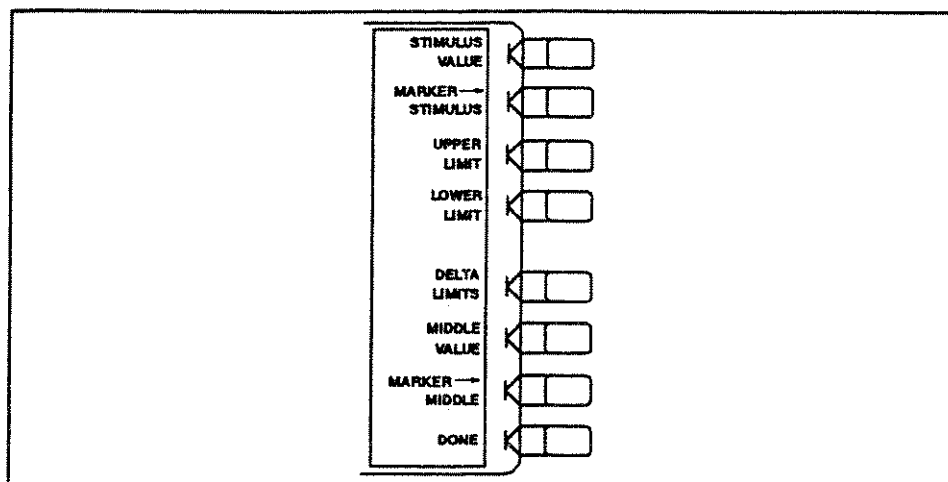

Figure 12-19. Edit Segment Menu

STIMULUS VALUE (LIMS) sets the starting stimulus value of a segment, using entry block controls.

MARKER → STIMULUS (MARKSTIM) sets the stimulus value of a segment using the active marker. Move the marker to the desired starting stimulus value before pressing this key, and the marker stimulus value is entered as the segment stimulus value.

UPPER LIMIT (LIMU) sets the upper limit value for the segment. If a lower limit is specified, an upper limit must also be defined. If no upper limit is required for a particular measurement, force the upper limit value out of range (for example +500 dB)

When **UPPER LIMIT** or **LOWER LIMIT** is pressed, all the segments in the table are displayed in terms of upper and lower limits, even if they were defined as delta limits and midpoint values.

If you attempt to set an upper limit that is lower than the lower limit, or vice versa, both limits will be automatically set to the same value.

LOWER LIMIT (LIML) sets the lower limit value for the segment. If an upper limit is specified, a lower limit must also be defined. If no lower limit is required for a particular measurement, force the lower limit value out of range (for example -500 dB).

DELTA LIMITS (LIMD) sets the limits an equal amount above and below a specified middle value, instead of setting upper and lower limits separately. This is used in conjunction with **MIDDLE VALUE** or **MARKER → MIDDLE**, to set the limits for testing a device that is specified at a particular value plus or minus an equal tolerance.

For example, a device may be specified at -5 dB ±3 dB. Enter the midpoint value as -5 dB and the delta limits as 3 dB.

When **DELTA LIMITS** or **MIDDLE VALUE** is pressed, all the segments in the table are displayed in these terms, even if they were defined as upper and lower limits.

MIDDLE VALUE (LIMM) sets the midpoint for **DELTA LIMITS**. It uses the entry controls to set a specified amplitude value vertically centered between the limits.

MARKER → MIDDLE (MARKMIDD) sets the midpoint for **DELTA LIMITS** using the active marker to set the middle amplitude value of a limit segment. Move the marker to the desired value or device specification, and press this key to make that value the midpoint of the delta limits. The limits are automatically set an equal amount above and below the marker.

DONE (LIMSDON) terminates a limit segment definition, and returns to the edit limits menu.

Clear List Menu

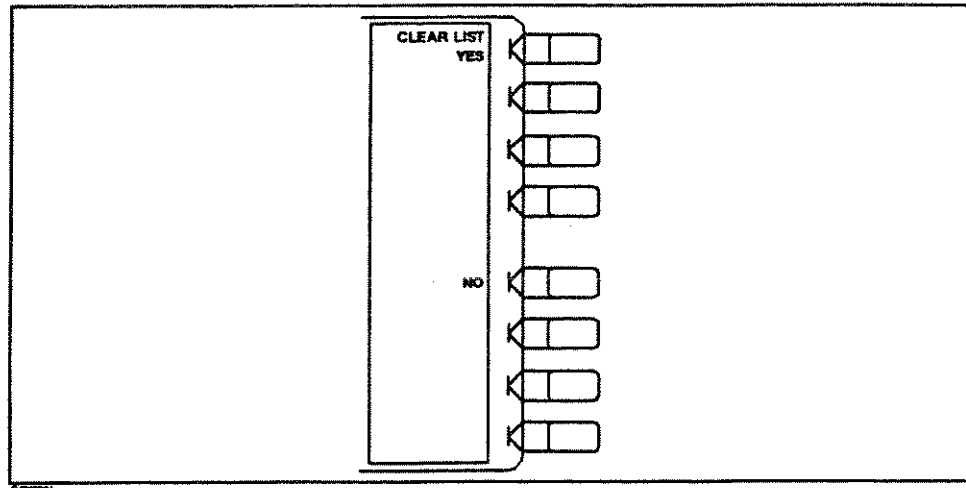

Figure 12-20. Clear List Menu

CLEAR LIST YES (LINCLEL) clears all of the segments in the limit line and returns to the edit limit menu.

NO cancels clearing the segment and returns to the edit limit menu.

Offset Limit Menu

This allows all segments to be offset in either stimulus value or amplitude value. This is useful for changing the limits to correspond with a change in the test setup, or for device specifications that differ in stimulus or amplitude.

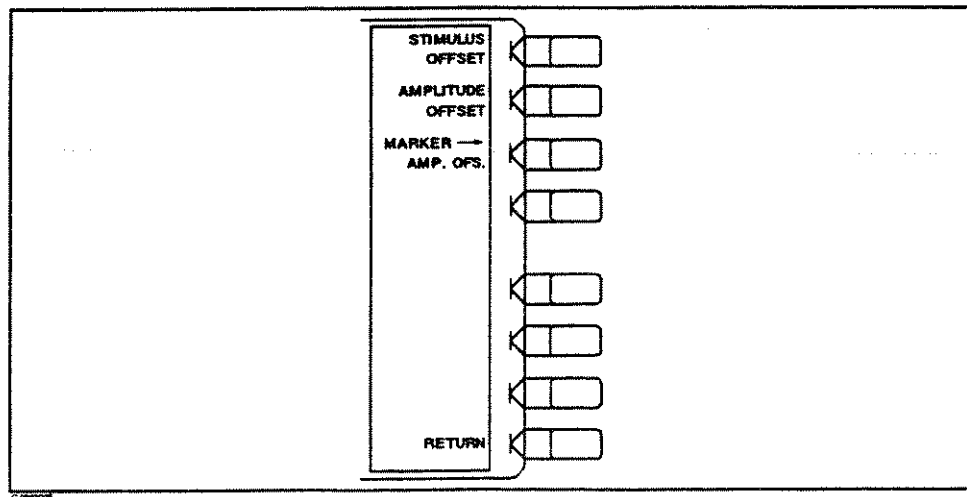

Figure 12-21. Offset Limit Menu

STIMULUS OFFSET (LIMISTIO) adds to or subtracts an offset from the stimulus value. This allows limits already defined to be used for testing in a different stimulus range. Use the entry block controls to specify the offset required.

AMPLITUDE OFFSET (LIMIAMP0) adds or subtracts an offset in amplitude value. This allows previously defined limits to be used at a different power level. For example, if attenuation is added to or removed from a test setup, the limits can be offset an equal amount.

MARKER → AMP. OFS. (LIMIMAOF) uses the active marker to set the amplitude offset. Move the marker to the desired middle value of the limits and press this softkey. The limits are then moved so that they are centered an equal amount above and below the marker at that stimulus value.

RETURN goes back to the limit line menu.

Using Limit Line Testing

The analyzer has limit line/testing functions for go/no-go testing. The limit lines define upper and lower limits, and the limit testing function compares the measured data to the limit lines and indicates the result. The following is a practical example of setting up limit lines for testing a bandpass filter.

Example of Limit Lines for Filter Testing

The following is an example of creating limit lines to test a 70 MHz crystal bandpass filter.

Instrument Setting

Press **PRESET** and then change these measurement settings:

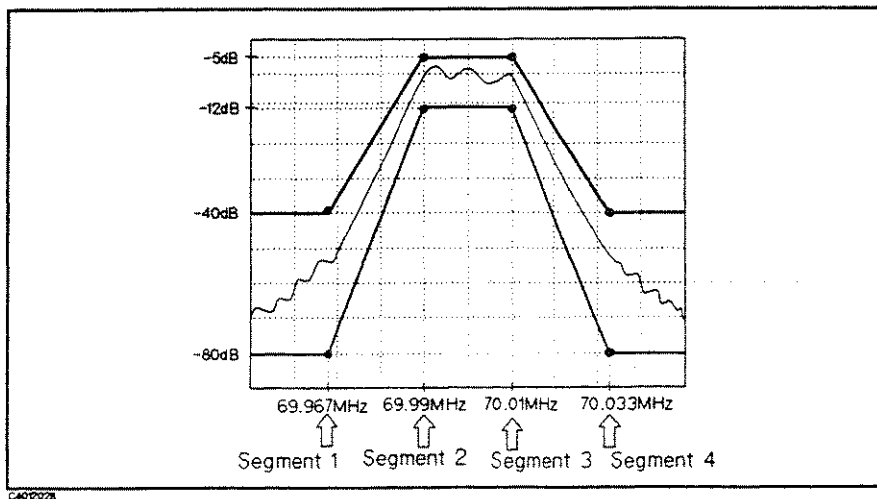

Figure 12-22. Limit Line Example

	Desired Setting	Key Strokes
Channel Block	Select channel 1	CH 1 (default)
Response Block	Select A/R measurement Select LOG MAG format	Press MEAS A/R FORMAT LOG MAG (default)
Stimulus Block	Center frequency 70 MHz Span frequency 100 kHz Number of points 401	Press CENTER 70 (M/μ) Press SPAN 100 (k/m) Press MENU NUMBER of POINTS 401 (x1)

Creating Limit Lines

Perform the following procedure, *see* Figure 12-23.

1. Press **(SYSTEM)** **LIMIT MENU** **LIMIT LINE** on **OFF** to **ON**
2. Press **EDIT LIMIT LINE** **EDIT**
3. For segment 1:
 - Press **STIMULUS VALUE** 69.967 **(M/μ)**
 - Press **UPPER LIMIT** -40 **(x1)**
 - Press **LOWER LIMIT** -80 **(x1)** **DONE**
4. For segment 2:
 - Press **ADD STIMULUS VALUE** 69.99 **(M/μ)**
 - Press **UPPER LIMIT** -5 **(x1)**
 - Press **LOWER LIMIT** -12 **(x1)** **DONE**
5. For segment 3:
 - Press **ADD STIMULUS VALUE** 70.01 **(M/μ)** **DONE**
6. For segment 4:
 - Press **ADD STIMULUS VALUE** 70.033 **(M/μ)**
 - Press **UPPER LIMIT** -40 **(x1)**
 - Press **LOWER LIMIT** -80 **(x1)** **DONE**
7. Press **DONE**

Note



The limit line segments do not have to be entered in any particular order: the analyzer automatically sorts them and lists them on the display in increasing order of stimulus value.

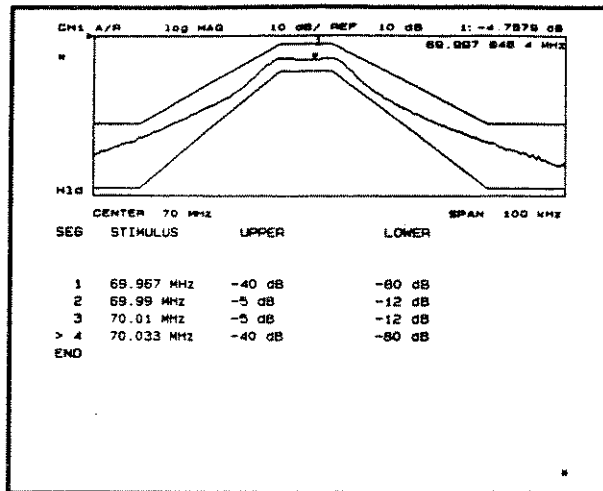

Figure 12-23. Editing the Limit Lines

Modifying Limit Lines Using The Rotary Knob and Marker

Any individual segment (and its associated limit lines) can be edited after creation. Using the marker and rotary knob is a very convenient way to modify limit lines. Use the following procedure:

1. To enter the actual measurement point for segments, press **(MKR) MARKER MODE MENU** **MARKER-DISCRETE** to place the marker on an actual measurement point only.
2. Press **(SYSTEM) LIMIT MENU EDIT LIMIT LINE**
3. Press **SEGMENT** (appropriate number) **(X1) EDIT**
4. To modify the upper/lower values:
Press **UPPER LIMIT** or **LOWER LIMIT** and rotate the knob.
5. To modify the stimulus point:
Press **(ENTRY OFF)** and move the marker to appropriate point, then press **MARKER-STIMULUS**.
Or press **STIMULUS VALUE** and rotate the knob.
6. Press **DONE**

Performing Limit Test

Press **LIMIT TEST** on **OFF** to **ON** to perform limit testing using the just edited limit lines. When the limit lines and testing are turned ON, an out-of-limit test result is normally indicated in six ways:

- With a FAIL message on the screen.
- With a beep (on/off selectable).
- With an asterisk in tabular listings of data (under **(COPY)**).
- With a bit in HP-IB event status register B.
- With a bit in the I/O port on the rear panel.
- With HP-IB commands OUTPLIMF?, OUTPLIMIL? and OUTPLIMM?.

Example 2. Separated Limit Lines

Figure 12-24 shows separated limit lines and its editing table example. This can be used for filter testing which only requires insertion loss limits. Dummy limit values (+500000 for upper and -500000 for lower, for example) should be entered for the no limit areas.

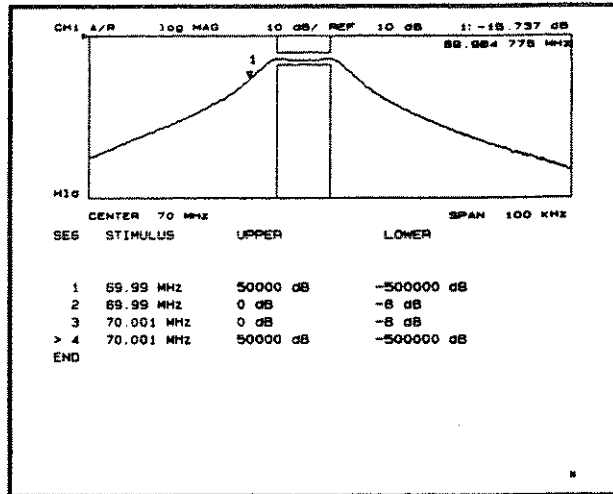

Figure 12-24. Limit Lines Example 2 (Separated Limit Lines)

Note



Limits are checked only at each of the actual measured data points. It is possible for a device to be out of specification without a limit test failure indication if you do not select sufficient stimulus points within a segment.

Note



Combining the limit test and the list sweep function, high throughput limit line/testing can be performed for go/no-go testing. For detail information on the list sweep, see Chapter 8.

Note



Limit line information is lost if you press **PRESET** or turn OFF the power. However, the **SAVE** keys can save the limit line information along with all other current instrument settings when the limit lines are on. See Chapter 14 for details.

Making Hard Copies

Introduction

About Making Hard Copies, Where Compatible Printers and Plotters are Mentioned

The analyzer can use HP-IB to output measurement results directly to a compatible printer or plotter, without the use of an external controller. The information shown on the display can be copied to a compatible Hewlett-Packard plotter or graphics printer. A plotter provides better resolution than a printer for data displays, while a printer provides higher speed for tabular listings. See Chapter 2 for information about compatible plotters and printers.

Where to Find Tutorial Information

Tutorial information on how to plot or print is supplied in "Using Printer and Plotter"

Printing/Plotting with or without a Controller on the Bus

To generate a plot or printout from the front panel when there is no other controller on the bus, the analyzer must be in the system controller HP-IB mode. If a controller is connected to the analyzer, the analyzer must take control from the controller to initiate a hard copy. To do this, the analyzer must be in the addressable mode by receiving a pass control command from the controller. The controller essentially gives the analyzer permission to control the bus.

See "Bus Mode" in Chapter 15 for HP-IB controller modes and "LOCAL Key" in Chapter 12 for setting addresses.

Note



The ASCII Save menu is provided under the **SAVE** key to save the graphics image on the screen in an HP-GL file on the disk. For more information, see Chapter 14.

Print/Plot Buffer

The analyzer can continue operation while a hard copy is in progress. To abort a hard copy before it is finished, press **COPY ABORT**. If a hard copy is in progress and a second hard copy is attempted, the message "PRINT/PLOT IN PROGRESS, ABORT WITH COPY ABORT" is displayed and the second attempt is ignored. An aborted hard copy cannot be continued: the process must be initiated again if a copy is still required.

COPY Key

The HP-IB programming command is shown in parenthesis following the key or softkey.

The **COPY** key provides access to the menus used for controlling external plotters and printers and defining the plot parameters.

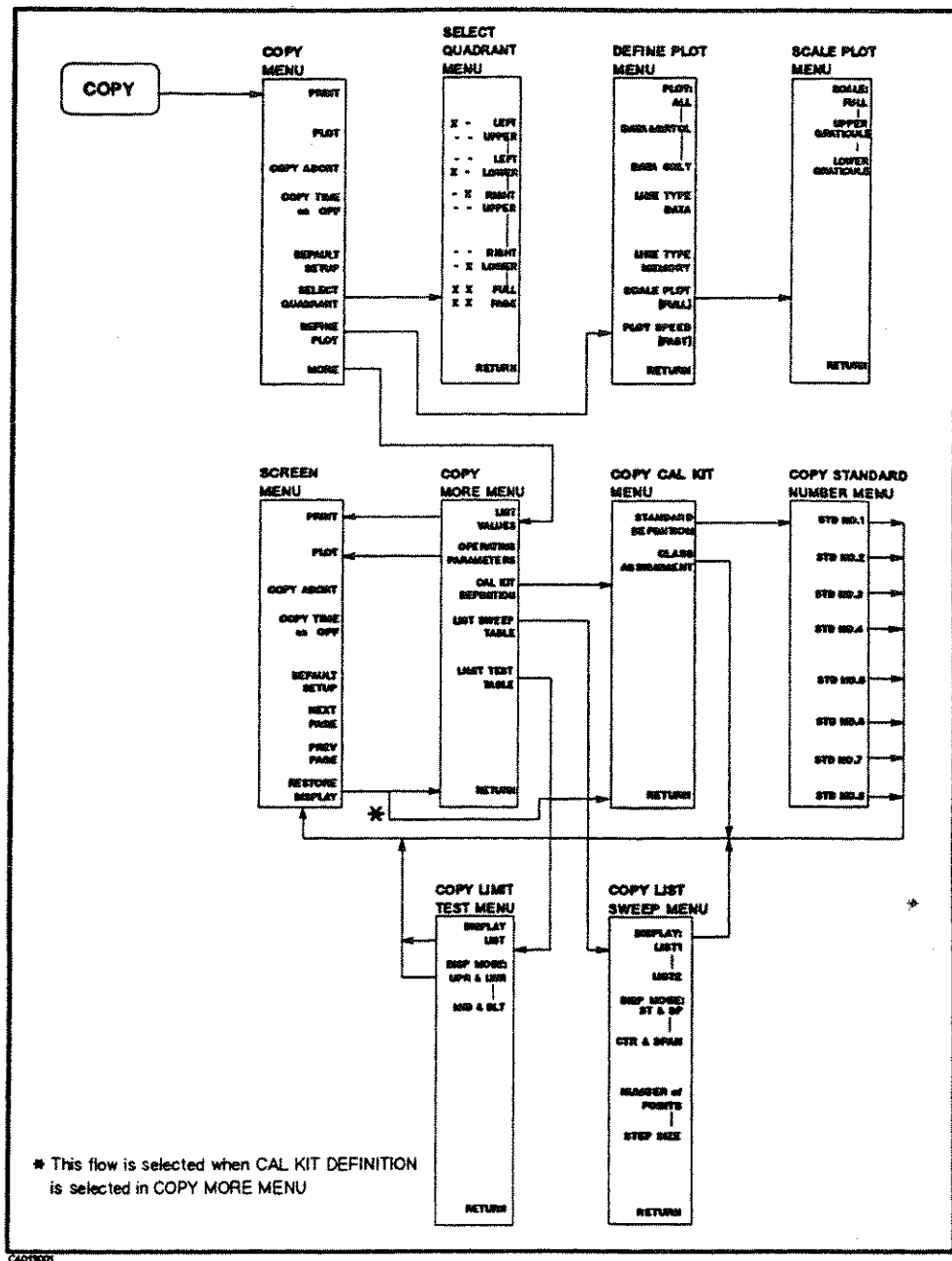

Figure 13-1. Softkey Menus Accessed from the **COPY** Key

Copy Menu

This copies the display to a printer or to a plotter using the default plot parameters, without the need to access other menus. For user-defined plot parameters, a series of additional menus is available.

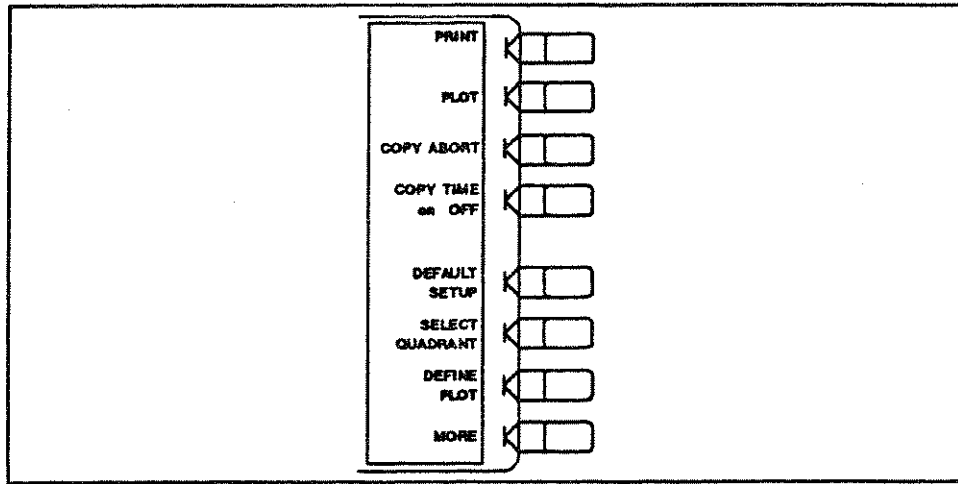

Figure 13-2. Copy Menu

When the print or plot function is engaged, the analyzer takes a “snapshot” of the display and sends it to the printer or plotter through a buffer. Once the data is transferred to the buffer, the analyzer is free to continue measurements while the data is being printed or plotted.

PRINT (PRINALL) causes an exact copy of the display to be printed.

PLOT (PLOT) plots the display to a compatible HP graphics plotter, using the currently defined plot parameters (or default parameters). Any or all displayed information can be plotted, except the softkey labels and the frequency list table in EDIT mode, or limit table in EDIT mode. (List values, operating parameters, or cal kit definition can be plotted using the screen menu explained later in this chapter. However, this is considerably slower than printing.)

Note Before pressing **PRINT** or **PLOT**, you must:



- set the analyzer to the system controller mode.
- make sure the analyzer's plotter HP-IB address and the plotter set HP-IB address match.

COPY ABORT (COPA) aborts a plot or print in progress.

COPY TIME on OFF (COPTON, COPTOFF) turns the “time stamp” ON or OFF for a print or plot. When you select print, the time and date are printed out first, followed by the information shown on the display. When you select plot, the time and date are plotted on the message area. See “(SYSTEM) Key” in Chapter 12 for setting the internal clock.

DEFAULT SETUP (DFLT) resets the plotting parameters to their default values. These defaults are as follows:

Table 13-1. Default Plotting Parameters

- Select quadrant: Full page
- Define plot: All plot elements ON
- Plot scale: Full
- Plot speed: Fast
- Line type: 7 (solid line) for both trace and memory

Default setups do not apply to printing.

SELECT QUADRANT leads to the select quadrant menu, which provides the capability of drawing quarter-page plots. This is not used for printing.

DEFINE PLOT leads to the define plot menu, which specifies which elements of the display are to be plotted. This is not used for printing.

MORE leads to the copy more menu, which prints or plots the measurement value list, operation parameter list, calibration kit definition list, list sweep table, or limit test table.

Select Quadrant Menu

This selects a full-page plot, or a quarter-page plot in any quadrant of the page.

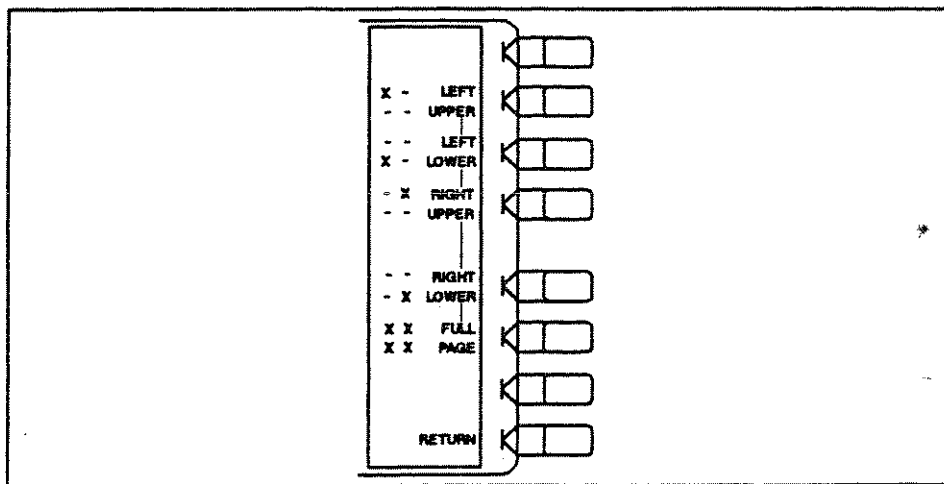

Figure 13-3. Select Quadrant Menu

LEFT UPPER (LEFU) draws a quarter-page plot in the upper left quadrant of the page.

LEFT LOWER (LEFL) draws a quarter-page plot in the lower left quadrant of the page.

RIGHT UPPER (RIGU) draws a quarter-page plot in the upper right quadrant of the page.

RIGHT LOWER (RIGL) draws a quarter-page plot in the lower right quadrant of the page.

FULL PAGE (FULP) draws a full-size plot according to the scale defined with **SCALE PLOT** in the define plot menu (described next).

RETURN returns to the copy menu.

Define Plot Menu

This menu allows selective plotting of portions of the measurement display. Different plot elements can be turned ON or OFF as required. In addition, different selections are available for plot speed and plot scale, to allow plotting on transparencies and preprinted forms.

The definition selected in this menu affects the save graphics function under the **SAVE** key, which saves a graphics screen image in an HP-GL file on the disk.

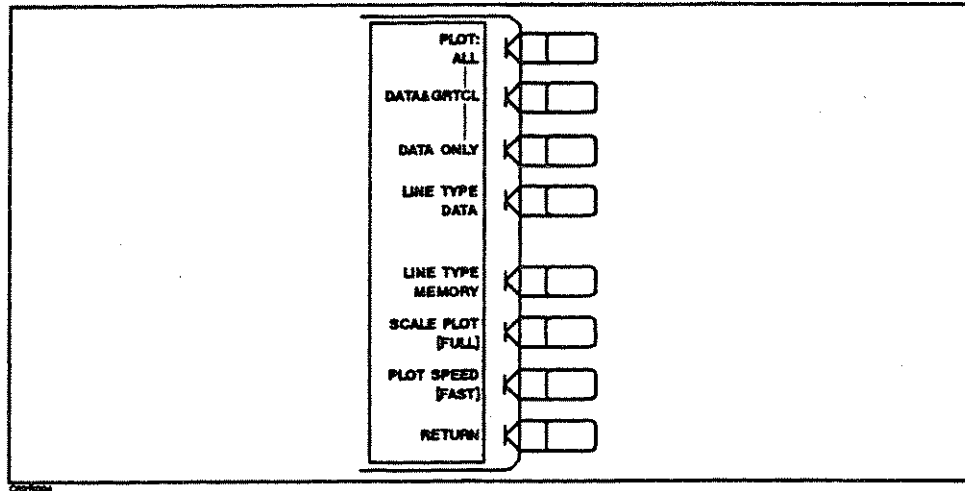

Figure 13-4. Define Plot Menu

Pen Numbers

Pen numbers for each display elements are fixed as follows:

Table 13-2. Pen Numbers

Display Element	Channel 1	Channel 2
Data	1	2
Memory	5	6
Graticule	3	3
Text	1 / 4 / 5	2 / 4 / 6
Marker	1 / 5	2 / 6

PLOT: ALL (PLOALL) selects to plot all the information displayed on the display except for the softkey labels.

DATA & GRATCL (PLODGRAT) selects to plot the measured data and memory data, and also the graticules.

DATA ONLY (PLODONLY) selects to plot only the measured data and memory data.

LINE TYPE DATA (LINTDATA) selects the line type of the trace data for plotting. The default line is a solid unbroken line. If line type is set to zero, the trace data on the screen is also specified dots only at measurement points.

LINE TYPE MEMORY (LINTMEMO) selects the line type of the trace memory for plotting. The default line type is a solid unbroken line. If line type is set to zero, the trace memory on the screen is also specified dots only at measurement points.

SCALE PLOT leads to the scale plot menu, which selects a plot scale.

PLOT SPEED (PLOSFAST, PLOSSLOW) provides two plot speeds, **FAST** and **SLOW**. Fast is the proper plot speed for normal plotting. Slow plot speed is used for plotting directly on transparencies: the slower speed provides a more consistent line width.

RETURN returns to the copy menu.

Scale Plot Menu

This menu selects a plot scale, **FULL**, **UPPER GRATICULE**, and **LOWER GRATICULE**.

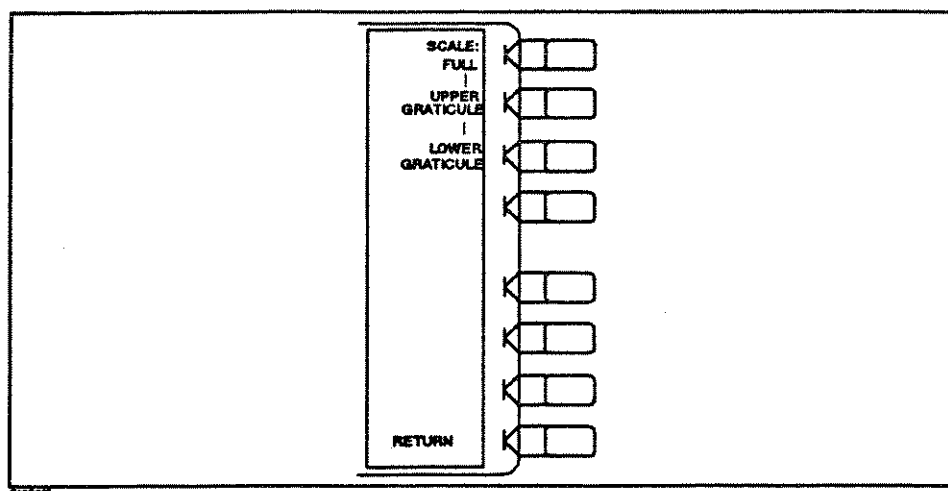

Figure 13-5. Scale Plot Menu

SCALE: FULL (SCAPFULL) selects the normal full size scale for plotting on blank paper, and includes space for all display annotations such as marker values, stimulus values, etc. The entire display fits within the user-defined boundaries of P1 and P2 on the plotter, while maintaining the exact same aspect ratio as the display.

UPPER GRATICULE, **LOWER GRATICULE** (SCAPGU, SCAPGL) expands or reduces the horizontal and vertical scale so that the graticule lower left and upper right corners exactly correspond to the user-defined P1 and P2 scaling points on the plotter. In the dual display mode, the applicable graticule is channel 1 for **UPPER GRATICULE**, or channel 2 for **LOWER GRATICULE**. This is convenient for plotting on preprinted rectangular or polar forms.

To plot on a rectangular preprinted graticule, set P1 of the plotter at the lower left corner of the preprinted graticule, and set P2 at the upper right corner.

To plot on a polar format as an accurate circle, set P1 and P2 so that a rectangle defined by P1 and P2 become a square because the outer circumference is identical to an inscribed circle in the rectangle.

When the display is split (for example, **SPLIT DISP ON**, **MKR LIST ON**), **UPPER** set the upper graticule to the plot area defined P1 and P2 and **LOWER** set the lower graticule to the plot area. When the display is not split, **UPPER** and **LOWER** are the same. (See Figure 13-6.)

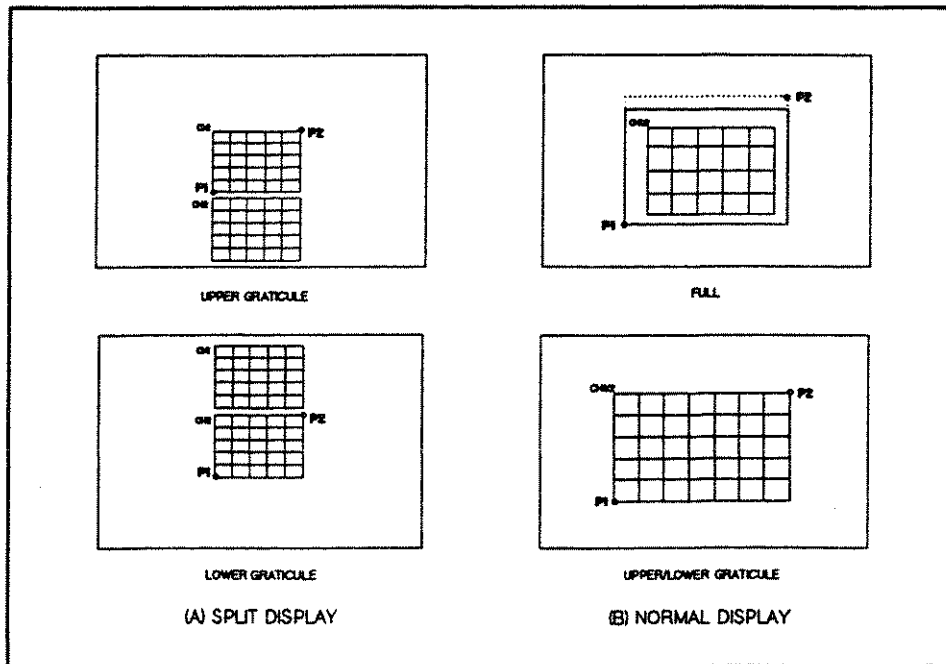

Figure 13-6. Full, Upper, and Lower Graticule

Copy More Menu

This menu provides tables of operating parameters, measured data values, and cal kit definitions, which can be copied from the screen to a printer or plotter.

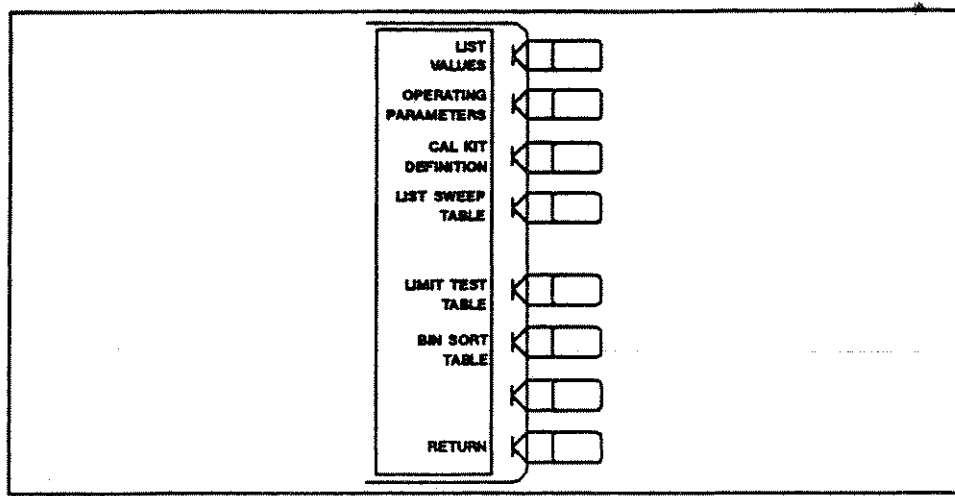

Figure 13-7. Copy More Menu

LIST VALUES (LISV) provides a tabular listing of all the measured data points and their current values, together with limit information if the limit test is ON. At the same time, the screen menu is presented to enable hard copy listings and access new pages of the table. Twenty one lines of data are listed on each page, and the number of pages is determined by the number of measurement points specified in the stimulus menu.

Table 13-3 shows data listed on the screen when **DUAL CHAN** is **OFF**. The margin listed is smaller difference value between measurement value and either upper limit or lower limit. When plus margin means the test is pass, and minus means fail.

LIST VALUES lists log magnitude values when the log magnitude format is selected as the display format, even if impedance (Z:trans) or admittance (Y:trans) is displayed using Conversion function (and markers show absolute values).

Table 13-3. List Value Format

Display Format	Column Number				
	1	2	3	4	5
LOG MAG PHASE DELAY LIN MAG REAL IMAGINARY EXPANDED PHASE	Stimulus	Measurement Data ¹	Margin ²	Upper Limit Value ²	Lower Limit Value ²
POLAR LOG MAG & PHASE LOG MAG & DELAY	Stimulus	Measurement Data ¹	Measurement Data	Upper Limit Value ²	Lower Limit Value ²

1 * is displayed at the left hand of measurement value when the it fails in the limit testing.

2 This is listed when the limit test is ON.

When **DUAL CHAN** is **ON**, stimulus values are listed in the first column, measurement data of the active channel are listed in the second and third columns, and the non-active channel data are listed in the fourth and fifth columns. The value listed for each channel are the same as data listed in the second and third columns in Table 13-3.

If **DUAL CHAN** is **ON** and **COUPLED CH IS OFF**, only active channel measurement data is listed.

OPERATING PARAMETERS (OPEP) provides a tabular listing on the display of the key parameters for both channels. The screen menu is presented to allow hard copy listings and access new pages of the table. Four pages of information are supplied. These pages list operating parameters, marker parameters, lists, and system parameters that relate to control of peripheral devices rather than selection of measurement parameters. The listed parameters are as follows:

- Number of points
- Sweep time
- Source power
- IF bandwidth
- Averaging factor
- Averaging switch
- Smoothing aperture
- Smoothing switch
- Group delay aperture
- Calibration kit
- Z₀
- Calibration type
- Stimulus conditions when the calibration was performed
- Phase offset
- Input R and A extension

■ Velocity factor

CAL KIT DEFINITION provides the copy cal kit menu which prints/plots the calibration kit definitions.

LIST SWEEP TABLE provides a tabular listing on the display of the list sweep table.

LIMIT TEST TABLE provides a tabular listing on the display of the limit value for limit testing.

BIN SORT TABLE provides a tabular listing on the display of the BIN definition value for the BIN sorting.

RETURN returns to the copy menu.

Copy Cal Kit Menu

This provides a tabular listing of the calibration kit definitions. The lists can be hard copied using the copy function. The elements are all the standard and class assignments.

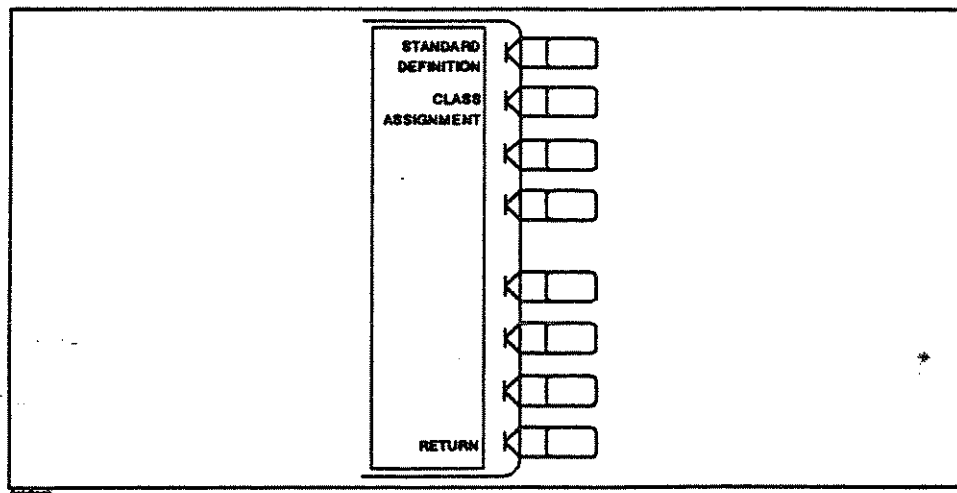

Figure 13-8. Copy Cal Kit Menu

STANDARD DEFINITION provides the copy standard number menu which selects which standard settings are to be hard copied.

CLASS ASSIGNMENT (CALCASSI) shows the tabular listing of the calibration kit class assignment, and provides the screen menu to prepare for hard copy.

RETURN returns to the copy more menu.

Copy Standard Number Menu

This selects which standard is to be hard copied.

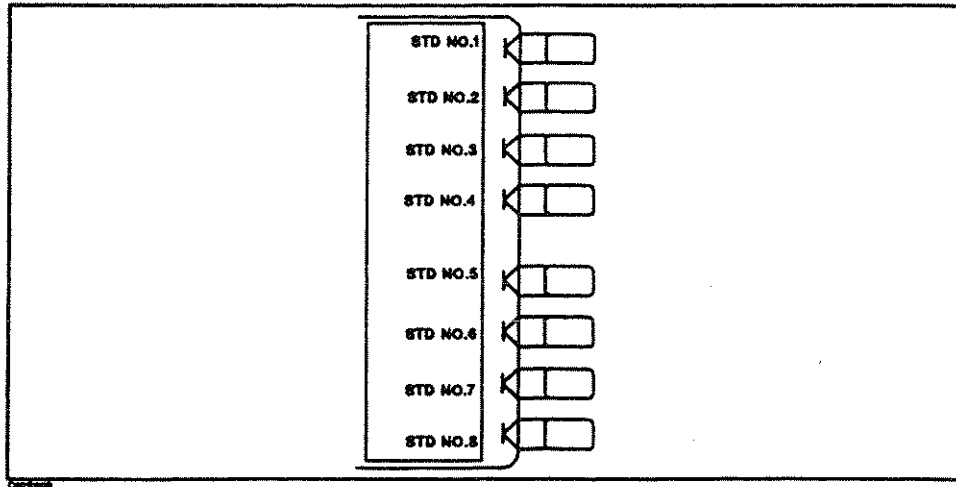

Figure 13-9. Copy Standard Number Menu

STD NO. n (CAL) provides the tabular listing of the standard definitions of the standard number *n*, and provides the screen menu to prepare for hard copy.

Copy List Sweep Menu

This selects one applicable list sweep table, and defines in what format the list sweep table is to be displayed and hard copied.

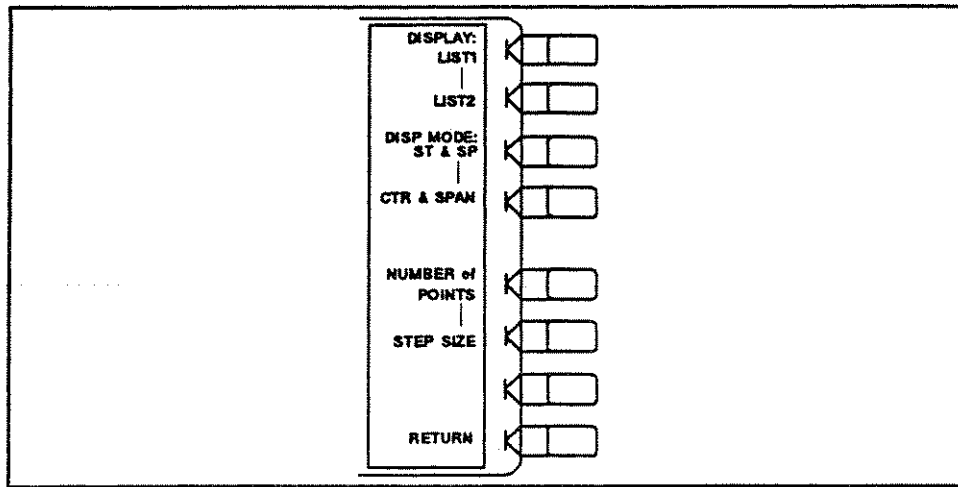

Figure 13-10. Copy List Sweep Menu

DISPLAY: LIST1 (DISL1) selects list sweep Table 1 to be displayed and hard copied.

LIST2 (DISL2) selects list sweep Table 2 to be displayed and hard copied.

DISP MODE: ST & SP (DISMSTSP) displays the list sweep stimulus range in terms of Start and Stop.

CTR & SPAN (DISMCTSP) displays the list sweep stimulus range in terms of Center and Span.

NUMBER of POINTS (DISMNUM) displays the list sweep stimulus resolution in terms of Number of Points.

STEP SIZE (DISMSTEP) displays the list sweep stimulus resolution in terms of Step Size.

Copy Limit Test Menu

This defines in what format the limit testing table is to be displayed and hard copied.

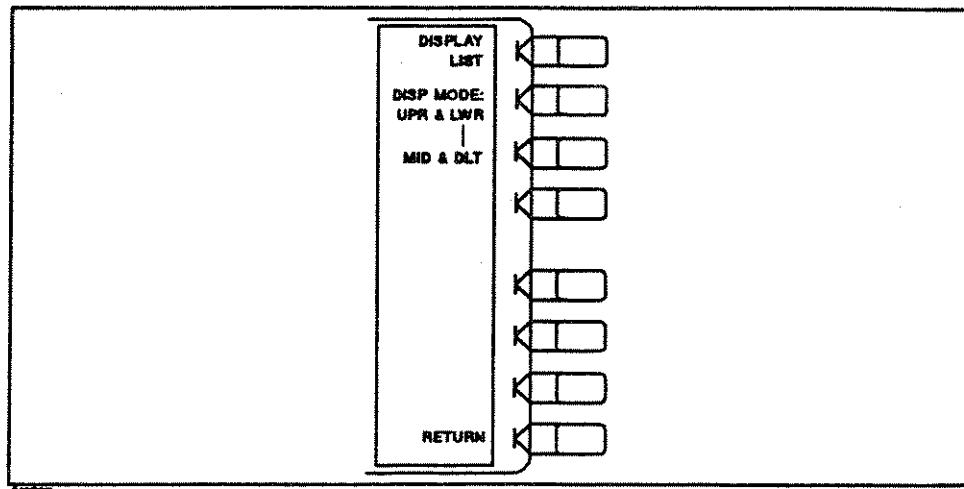

Figure 13-11. Copy Limit Test Menu

DISPLAY LIST (DISLLIST) displays the limit testing table on the display, and provides the screen menu to prepare for hard copy.

DISP MODE: UPR & LWR (DISMUL) selects the upper and lower format, which displays the limit values by upper limit and lower limit.

MID & DLT (DISMMD) selects the middle and delta format, which displays the limit values by middle value and maximum deviation (limit value) from the midpoint value.

Screen Menu

This menu is used in conjunction with the **LIST VALUES**, **OPERATING PARAMETERS**, **CAL KIT DEFINITION**, **LIST SWEEP TABLE**, and **LIMIT TEST TABLE** features, to make hard copy listings of the tables displayed on the screen. To make copies from the front panel, make sure that the analyzer is the system controller (see Chapter 12).

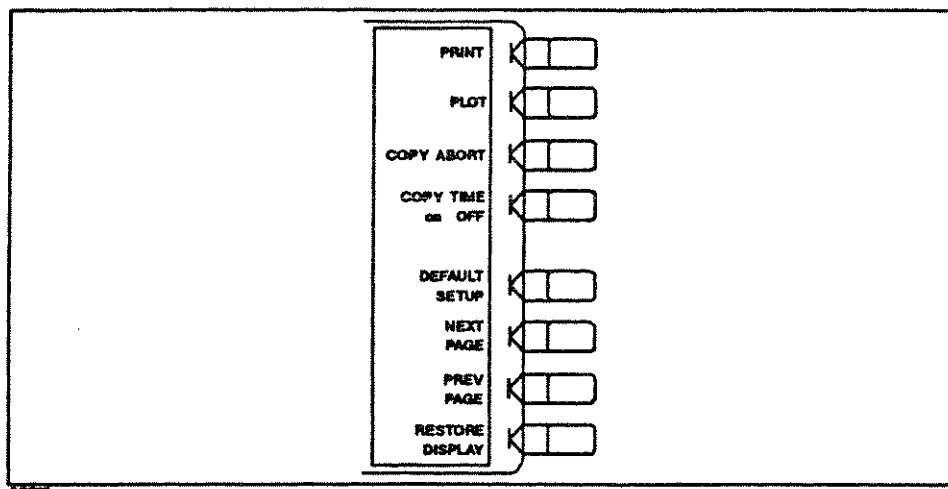

Figure 13-12. Screen Menu

PRINT (PRINALL) copies one page of the tabular listings to a compatible HP graphics printer.

PLOT (PLOT) plots one page of the tabular listing on the display using the current setup (defined in **SELECT QUADRANT** and **DEFINE PLOT**). Plot size and speed can be change in **DEFINE PLOT MENU** if you want.

Note Before pressing **PRINT** and **PLOT**, you must:



- set the analyzer to the system controller mode.
- make sure the analyzer's printer HP-IB address and the printer set HP-IB address match.

COPY ABORT (COPA) aborts a plot or print in progress.

COPY TIME on OFF (COPTON, COPTOFF) turns printing or plotting time and date ON or OFF. When you select print, the time and date are printed first, then the information displayed on display. When you select plot, time and date are plotted just below the title area. See "**SYSTEM Key**" in Chapter 12 for setting the internal clock.

PRINT/PLOT SETUPS presents the print/plot setups menu. Graphics printer and plotter are set from this menu.

NEXT PAGE (NEXP) displays the next page of information in a tabular listing onto the display.

PREV PAGE (PREP) displays the previous page of information in a tabular listing onto the display.

RESTORE DISPLAY (RESD) turns OFF the tabular listing and returns the measurement display to the screen.

Using Printer and Plotter

This section describes key features and the basic procedure of using the printing/plotting functions.

Preparing Printers/Plotters

The HP graphics printers and plotters that have an HP-IB interface can be used (See Chapter 2). Connect a printer or plotter to the HP 87510A with an HP-IB cable. The HP-IB address should be set as follows:

- Printer : set to address 1
- Plotter : set to address 5

Available Displays To Print/Plot

- The display on any of the display formats
- List values (tabular format) All the measured data points and limit information (if it is turned ON) are listed.
- Operating parameters (tabular format) The instrument states (key parameters for both channels) are listed.
- Calibration kit definition (tabular format)

The sweep list and limit lines editing display can be output only by using an external computer.

To display the tabular format, press **COPY** **MORE**, and **LIST VALUES**, **OPERATING PARAMETERS**, or **CAL KIT DEFINITION**.

Output with The Time/Date

The analyzer can print or plot the display with the time and date by pressing **COPY** **COPY TIME on OFF** to **ON**.

Adding a Title

To print or plot a display with a comment, you can enter a *title* on the display. Create a title using **TITLE** under the **DISPLAY**. (See Chapter 9.) The title will be printed or plotted with the data.

Printing Procedure

1. To set the analyzer to the system controller mode, press **LOCAL** **SYSTEM CONTROLLER**.
2. If needed, set the time and title (see "Output with The Time/Date" and "Adding a Title").
3. Press **COPY**.
4. Press **PRINT** to start printing.

If you need to abort printing, press **COPY ABORT**.

Plotting Procedure

1. To set the analyzer to the system controller mode, press **LOCAL** **SYSTEM CONTROLLER**.
 2. If needed, set the time and title (see "Output with The Time/Date" and "Adding a Title").
 3. Press **COPY**.
 4. If needed, press **DEFINE PLOT** to select the display elements to be plotted.
 - a. To plot all information on the display, press **PLOT: ALL**.
 - b. To plot traces and graticules only, press **DATA & GRATCL**.
 - c. To plot traces only, press **DATA ONLY**.
- Then press **RETURN**.
5. Press **PLOT** to start plotting.

Printing and Plotting Troubleshooting

1. Look for an error message on the CRT. (See *Error Messages*.)
2. Make sure the printer/plotter is plugged in, turned ON, connected to the analyzer, and loaded with paper.
3. Make sure the analyzer is in the system controller mode. Press **LOCAL** **SYSTEM CONTROLLER**.
4. Make sure the HP-IB address of the device and the address recognized by the analyzer match (see Chapter 1).
5. Replace the HP-IB cable.
6. If all of the above fails, contact Hewlett-Packard for assistance.

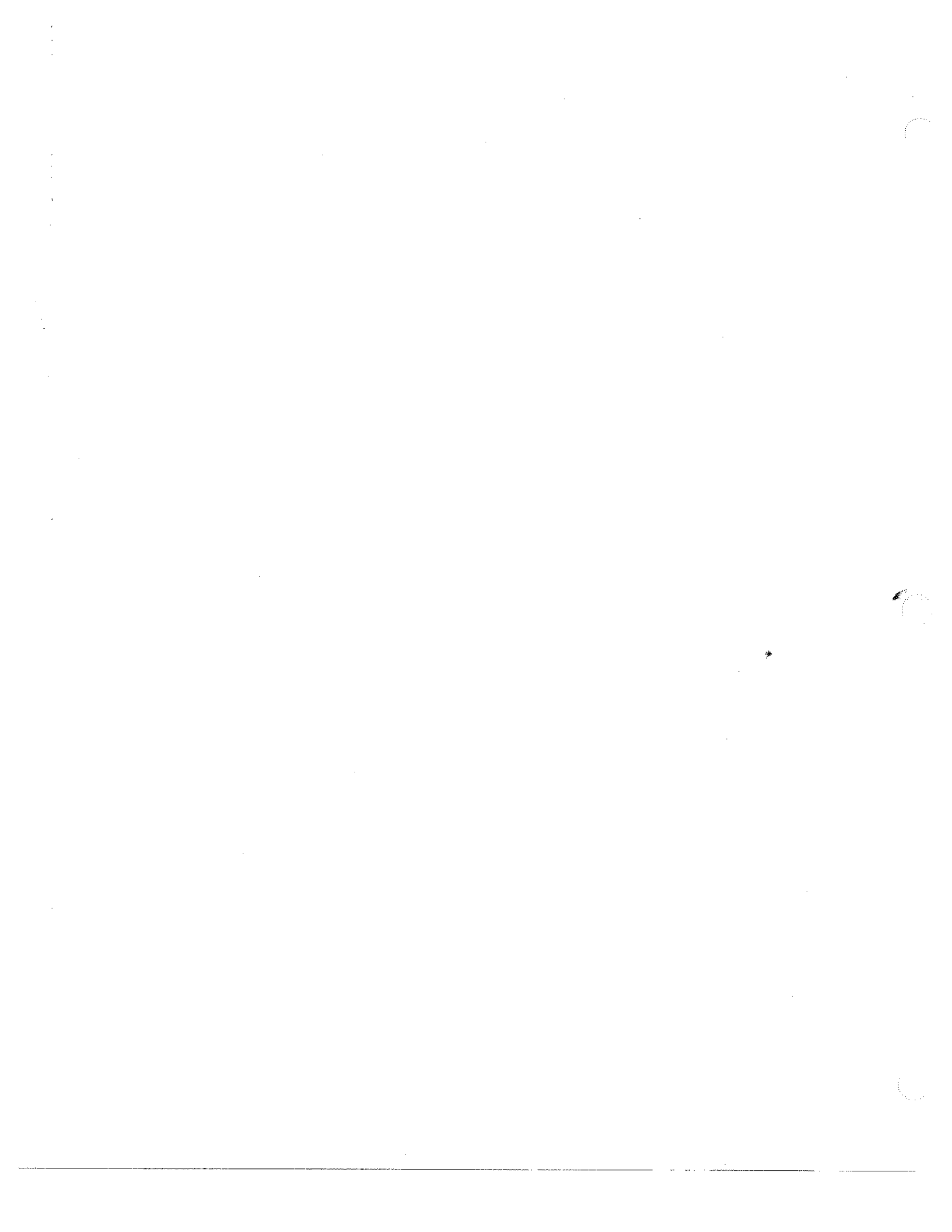

Saving and Recalling Instrument States and Data

Introduction

This chapter describes how to save and recall instrument states and data for later retrieval using the built-in disk drive and the RAM disk memory.

This chapter explains the following:

- What information is saved
- **SAVE**, **RECALL** key menu description

Note



The **SAVE** and **RECALL** keys do not access Instrument BASIC programs. Instrument BASIC has its own menus (under **SYSTEM** key) for accessing the built-in disk drive. See "Instrument BASIC" in Chapter 12 for detail.

Storage Devices

The analyzer supports two storage devices, a built-in flexible disk drive and a RAM disk memory. The flexible disk drive is suited to storing large numbers of files and long term data storage. RAM disk is suited to storing tentative data and instrument states and to store or get data quickly.

Note



Use the built-in flexible disk to store important data, because the RAM disk data is lost when the power to the RAM disk memory is lost for more than 72 hours. The operating time of the battery backup for RAM disk memory is approximately 72 hours after the analyzer is turned OFF.

File Types and Data Saved

Binary Files and ASCII Files

The analyzer supports two file formats, binary and ASCII, in which to save data on a disk and memory. Binary files are used to save measurement conditions and data using the SAVE function, and to retrieve binary data using the RECALL function. External controllers and Instrument BASIC can read measurement data from binary data files. ASCII measurement data or screen image files can be read by commonly available IBM PC based software for data analysis or other secondary functions. The RECALL function can NOT read ASCII files.

Note



ASCII data files can not be recalled on the HP 87510A. If you need to recall the data, save the file in binary format. This binary data can be recalled and saved as an ASCII file at any time.

Data Groups

You can select and save one of the following five combinations between two file types and four data groups to a disk.

- Binary File
 - Instrument states
 - Internal data arrays
 - Instrument states and internal data arrays
- ASCII File
 - Internal data arrays (ASCII format)
 - Graphics image

Note



DATA ONLY does not save the instrument settings such as Start and Stop frequencies. BE CAREFUL! When you first start a series of measurements Always make sure that you save ALL for your first measurement with a particular setting.

Instrument States

The instrument state group consists of all front panel settings and the calibration coefficient arrays. This data group can retrieve identical measurement conditions for later use.

Internal Data Arrays

The internal data arrays which are essentially stored in the analyzer's memory consists of the following three data arrays. See "Data Processing" in Chapter 4 for complete information on each data array and their relationships.

- *Calibration Coefficients arrays* hold the expanded calibration coefficients obtained by calibration.
- *Trace arrays* hold the formatted data. This is identical with the "Data trace arrays" described in "Data Processing" in Chapter 4.
- *Sub trace arrays* hold the formatted data of the "sub trace arrays".

These arrays can be saved selectively to suit the application. For example, when measuring a number of devices with the same measurement settings, you may need to save only the *trace arrays* for each device.

Saving only the necessary arrays reduces the disk space required and the disk access time.

In addition, saving internal data also allows the analysis of the measurement results using an external controller. See "File Structure of Internal Data Arrays File for Binary Files" for more information.

Instrument States and Internal Data Arrays

These consist of the instrument states which includes measurement data. However, saving and retrieving the complete states and data, occupies a lot of disk space.

Internal Data Arrays (ASCII file)

The internal data arrays saved in an ASCII file consists of the same three data arrays as saved in a binary file.

Graphics

Graphics consists of graphic images on the screen created using HP-GL (Hewlett-Packard Graphics Language). The HP-GL format is supported by most drawing software, and is the format used by most plotters.

Additional Information

RAM Disk Memory Capacity

The RAM disk memory capacity is 63 kbytes which includes the directory area. The capacity of data area depends on the disk format type. The following table shows the capacity of the data area by disk formats:

RAM Disk Memory Capacity

LIF Format	DOS format
58.75 kbyte	58 kbyte

Operating Time of the Battery Backup for RAM Disk Memory

The operating time of the battery backup for RAM disk memory is approximately 72 hours after the analyzer is turned OFF.

Disk Requirements

The analyzer disk drive uses a 720 k, or 1.44 Mbyte 3.5 inch micro-flexible disk. See the "System Accessories Available" section in Chapter 2 for disk part numbers.

Disk Formats

The analyzer's built in disk drive can access both LIF (logical interchange format) and DOS formatted disks. The disk drive can also initialize a new disk in either LIF or DOS format. The RAM disk memory can also use a format of either LIF or DOS.

The following list shows the applicable DOS formats for the HP 87510A.

- 720 kbyte, 80 tracks, double-sided, 9 sectors/track
- 1.44 Mbyte, 80 tracks, double-sided, 18 sectors/track

File Names

All data saved using the built in disk drive has an identifying file name. A file name consists of the lower and upper case alphabet, numbers, and valid symbol characters. Up to 8 characters can be used for a file name. The following table shows the valid characters for LIF and DOS file names.

Table 14-1. Valid Characters for File Names

Valid Characters		Description
LIF	DOS Format	
A - Z	A - Z	Upper case alphabet
a - z	a - z	Lower case alphabet
0 - 9	0 - 9	Numeric characters
-	\$ & # % ' ! () - _ @ ^ { } ~	Symbol characters

One of the following suffixes or extensions is automatically added to the file name depending on the data group type stored in the file.

Table 14-2. Suffixes and Extensions Added Automatically

Data Groups	Suffixes for LIF	Extensions for DOS
Instrument States (STATE ONLY)	_S	.STA
Internal Data Arrays (DATA ONLY (binary))	_D	.DTA
Instrument States And Internal Data Arrays (ALL)	_A	.ALL
Internal Data Arrays as an ASCII File (DATA ONLY (ASCII))	_I	.TXT
Graphics Image as an HP-GL File (GRAPHICS)	_G	.HPG

Copy Files Between the RAM Disk and the Flexible Disk

A copy function is provided to copy files between the RAM disk and the flexible disk.

FILE UTILITY in the SAVE menu leads the softkey to copy files. The HP-IB command "file" is also available to copy files.

Note



Use the same disk format type between the RAM disk and the flexible disk when you copy files using this function. This copy function can not copy files when the format type of the RAM disk is different from the format of the flexible disk.

Auto Recall Function

When the analyzer is turned on, it looks for a file named "AUTOREC" from the built-in flexible disk, and if found, the analyzer automatically reads the file to retrieve its data. If the analyzer does not find the file, the analyzer looks for the file from RAM disk.

File Size

The maximum number of files that can be saved on a disk depends on the disk capacity and the total size of the files to be saved. The file size depends on the analyzer settings, such as number of points, calibration type, etc.

Table 14-3 shows the approximate file sizes (in bytes) of binary files versus the number of points when the default settings are stored.

Table 14-3. File Size Versus Number of Points (binary files)

Number of Points	State only	Data only			All
		Cal	Data Trace	Sub Trace	
201	3.4 k	19 k	6.5 K	6.5 k	17 k
401	3.4 k	33.6 k	13 k	13 k	30 k
801	3.4 k	77 k	26 k	26 k	55 k

Table 14-4 shows the approximate file sizes (in bytes) of ASCII files versus the number of points when the default setting is stored.

Table 14-4. File Size Versus Number of Points (ASCII files) 1/2

Number of Points	Data only	
	Data Trace	Sub Trace
201	9 k	9 k
401	18.5 k	18.5 k
801	25.7 k	25.7 k

Table 14-5 lists the approximate file sizes (in bytes) versus the number of points when calibration data is saved in an ASCII file with each calibration type turn on.

Table 14-5. File Size Versus Number of Points (ASCII files) 2/2

Number of Points	Calibration Data only			
	Correction Off	Response	Response and Isolation	3-term
201	4 k	9 k	15 k	20 k
401	8 k	18 k	30 k	40 k
801	16 k	36 k	60 k	80 k

File Structure of Internal Data Arrays File for Binary Files

Note Binary and ASCII file structures are not compatible.



When internal data arrays are saved as a binary file, the arrays' file consists of a file header at the top of the file and the data groups following the file header.

See *HP-IB Programming Manual* for an example BASIC program you can use to access the data.

File Header

Every internal data array file begins with a file header. Figure 14-1 shows the header structure.

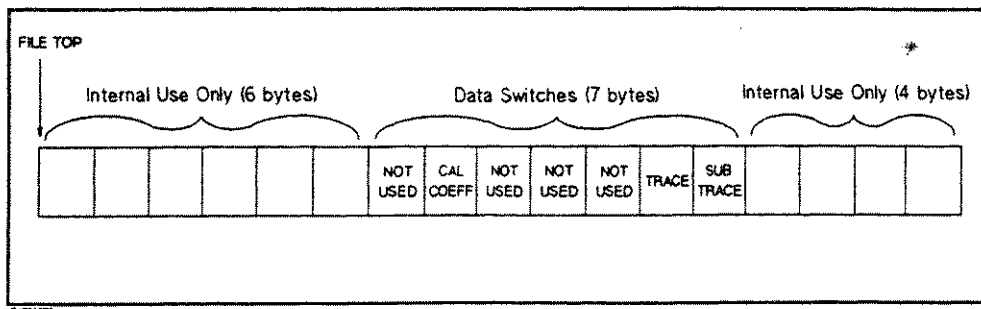

Figure 14-1. File Header Structure

Seven data switches define which data groups follow the file head. Each one-byte switch is either 1 or 0 (decimal value) if the applicable data group exists or not, respectively (if a bit is not used, it is always zero). The data group to be followed is in the same order of these switches. For example, when the data switch, TRACE is 1 (ON), while the others are OFF, only the TRACE (in this order) group will follow the header.

Data Group

Every data group consists of the same structured data segments. The number of data segments depends on the data group type as follows:

- **CAL** consists of six data segments as shown in Figure 14-2. The first half of the segments are for channel 1, and the second half of the segments are for channel 2. The contents of each segment depends on the type of calibration performed. (See Chapter 10.)

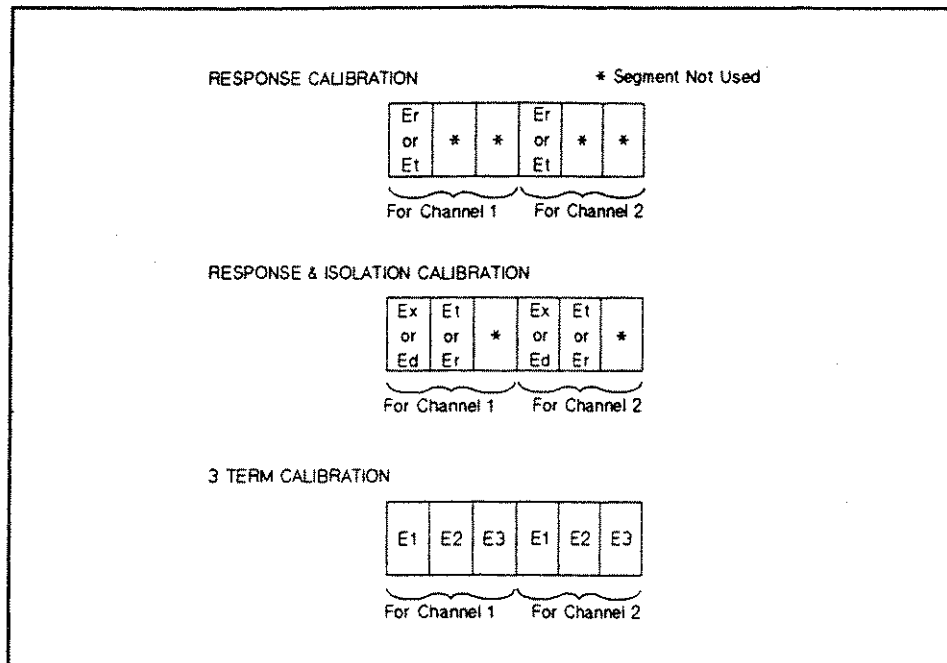

Figure 14-2. CAL Data Group Structure

- *DATA TRACE* consists of two data segments.
- *SUB TRACE* consists of two data segments.

Data Segment

The data segment structure is as shown in Figure 14-3.

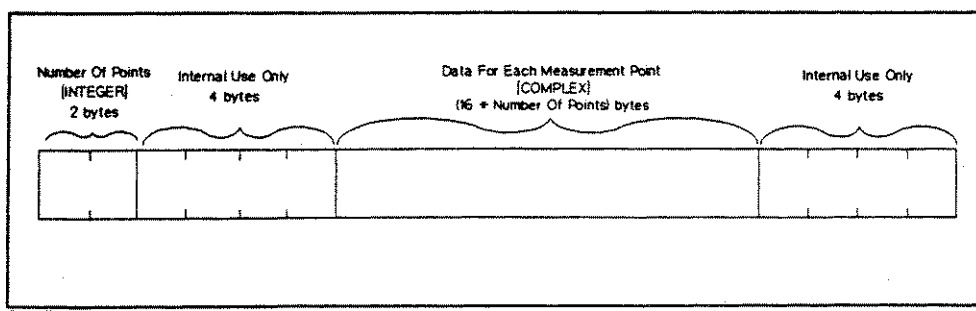

Figure 14-3. Data Segment

- *Number Of Points (NOP)* is a two-byte INTEGER value. This number is equal to the number of complex data which follows.
- *DATA* is a set of the values for each measurement point. The values are two IEEE 754 double precision floating numbers (first value as real part, second value as imaginary part). The data size in bytes can be determined by $16 \times \text{NOP}$.

File Structure of Internal Data Arrays File for ASCII File

Numerical data and strings in an ASCII data file are separated by a tab, and a string is bound by double quotation marks.

Status Block and Data Block

An ASCII data file consists of a status block and data blocks. The status block consists of two lines, the revision number and the date code. The Data block consists of three parts, the state part, the title line, and the data part.

■ State

The state part consists of the following instrument states:

- Channel number
- Title on the screen
- Measurement type
- Format type
- Number of points
- Sweep time
- Sweep type
- Source power
- IF bandwidth

■ Title

The title part consists of the data array names saved. Data array names are described in the next section.

■ Data

The data part consists of stimulus and measurement numerical data.

Table 14-6 shows an example of an ASCII data file.

Table 14-6. Contents of ASCII Files

Block Names		Contents
Status Block		"87510A REV1.00" "DATE: Apr 21 1992" ¹
Data Block	State	"CHANNEL: 1" "TITLE: This is a title." ² "MEAS TYPE: A/R" "FORMAT TYPE: LOG MAG" "NUMBER of POINTS: 201" "SWEEP TIME: 12.2 ms" "SWEEP TYPE: LIST FREQ" "SOURCE POWER: 0 dBm" "IF BANDWIDTH: 4 kHz"
	Title	"Frequency"→"Raw [S11] Real"→"Raw [S11] Imag"→... ^{3,4}
	Data ⁵	3.00000E+5→8.20007E-1→4.09729E-1→... ³ 1.52238E+7→9.32143E-1→-4.1914E-2→... : :

1 This is the date when the file is saved.

2 This line is listed when the title is defined (displayed).

3 "→" means tab code. Data is separated by the tab code.

4 This line lists the names of the data array saved in this file. Titles used in the ASCII files are shown in Table 14-5 through Table 14-8.

5 Each line lists the measurement data at each measurement point. The number of Lines in the data block is the same as the number of points.

Recalling

File Structure for Single Channel and Dual Channel

If you save an ASCII file when DUAL CHANNEL is turned OFF, the ASCII data file consists of the active channel's data. If DUAL CHANNEL is turned ON, the ASCII data file consists of the data of both channels 1 and 2. The channel 2 data follows the channel 1 data as follows:

File Structures for Single and Dual Channels

Dual Channel OFF	Dual Channel ON
Status Block	Status Block
Data Block of Active Channel	Data Block of Channel 1
(end of file)	Data Block of Channel 2

Data Array Names

Data array names are used in the title line of the data block. Each real and imaginary part of the internal data array has one name, Table 14-7 lists all names.

Table 14-7. Data Groups and Data Array Names

Data Groups	Data Array Names		Descriptions
	Real Part	Imaginary Part	
Calibration Data	Cal[1] Real	Cal[1] Imag	Et, ¹ Ex, ² E ₁ ³
	Cal[2] Real	Cal[2] Imag	Et, ² E ₂ ³
	Cal[3] Real	Cal[3] Imag	E ₃ ³
Trace	Trace Real	Trace Imag	Trace (format) arrays
Sub Trace	Sub Trace Real	Sub Trace Imag	Sub Trace (format) arrays

1 When response calibration are used.

2 When response and isolation calibration are used.

3 When 3-term calibration is used.

Data Groups

Every data group consists of data arrays. The number of data arrays depend on the data group types. The saved data array CAL depend on the instrument state.

- CAL DATA consists of twenty data arrays. The data arrays saved depend on the calibration type used. Table 14-8 lists the CAL data arrays, which are saved for each calibration type selected.

Table 14-8. Calibration Type Versus CAL Data Saved

Calibration Type	CAL Data Saved	Error Terms ¹
Response	"Cal[1] Real", "Cal[1] Imag"	Et
Response and Isolation	"Cal[1] Real", "Cal[1] Imag"	Ex
	"Cal[2] Real", "Cal[2] Imag"	Et
1 port Calibration	"Cal[1] Real", "Cal[1] Imag"	E ₁
	"Cal[2] Real", "Cal[2] Imag"	E ₂
	"Cal[3] Real", "Cal[3] Imag"	E ₃

¹ For more information on error terms, see "Appendix to Chapter 7"

SAVE and **RECALL** Keys

The HP-IB programming command is shown in parenthesis following the key or softkey.

The **SAVE** key provides access to all the menus used for saving instrument states and data on the disk. This includes the menus used to define titles for disk files, to define the content of disk files, to initialize disks for storage, and to purge files from a disk.

The **RECALL** key leads to the menus that recall the contents of disk files back into* the analyzer.

Caution



NEVER remove a disk from the disk drive, when the drive is accessing the disk. During disk access, the yellow LED on the drive lights.

Save Menu

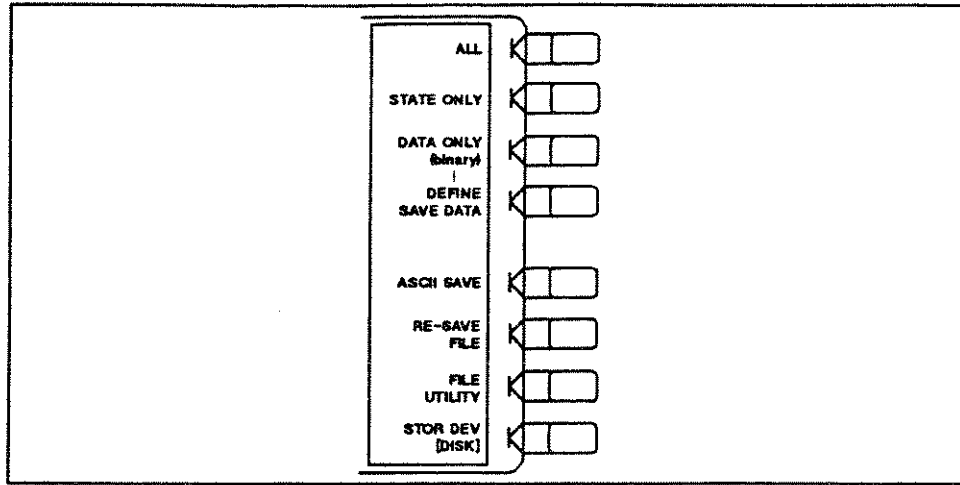

Figure 14-5. Save Menu

ALL (SAVDAL) specifies saving the instrument states, calibration coefficients, and data trace, and sub trace.

STATE ONLY (SAVDSTA) specifies saving only the instrument states and the calibration coefficients.

DATA ONLY (binary) (SAVDDAT) specifies saving the internal data arrays which are defined using the **DEFINE SAVE DATA** key.

DEFINE SAVE DATA provides the define save data menu, which selects the applicable data arrays to be saved.

ASCII SAVE leads to the ASCII Save Menu, from which to save data or graphic screen images to an ASCII file.

RE-SAVE FILE (RESAVD) leads to the Re-save File menu, to update a file which is already saved.

FILE UTILITIES provides the disk menu, which initializes a new disk, and purges a file from a disk.

STOR DEV (STODDISK STODMEM0) selects between the flexible disk drive and the RAM disk memory as the storage device. **[DISK]** shows the built-in flexible disk is selected and **[MEMORY]** shows the RAM disk memory is selected. This setting does not change even when the line power is cycled or the **PRESET** key is pressed.

Title Menu

This menu defines the file name to be saved.

The file name can be up to eight characters long, alphabetic (upper and lower case), numeric, special characters, see Table of Valid Characters in the file names section. If more than eight characters are entered, the last character is over written each time you type in a character.

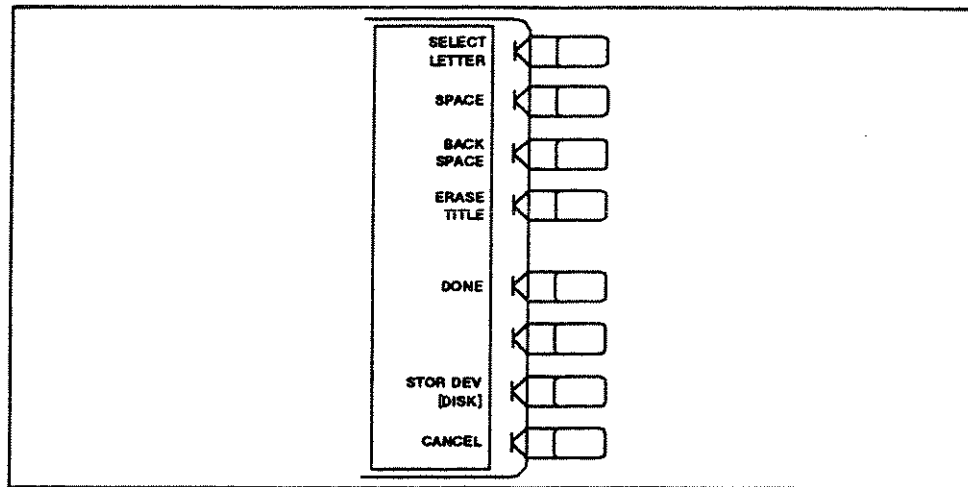

Figure 14-6. Title Menu

SELECT LETTER The active entry area displays the letters of the alphabet, numerals, etc. To define a title, rotate the knob until the arrow \uparrow points to the desired letter, then press **SELECT LETTER**. Repeat this procedure until the file name is defined, for a maximum of eight characters.

SPACE Don't use this key because LIF and DOS file formats don't allow spaces in file names.

BACK SPACE deletes the last character entered.

ERASE TITLE deletes the entire file name.

DONE saves the data specified in the define save menu and returns to the Save menu.

STOR DEV (STODDISK STODMEMO) selects between the flexible disk drive and the RAM disk memory as the storage device. **[DISK]** shows the built-in flexible disk is selected and **[MEMORY]** shows the RAM disk memory is selected. This setting does not change even when the line power is cycled or the **PRESET** key is pressed.

CANCEL quits this menu without saving the file, and returns to the Save menu.

ASCII Save Menu

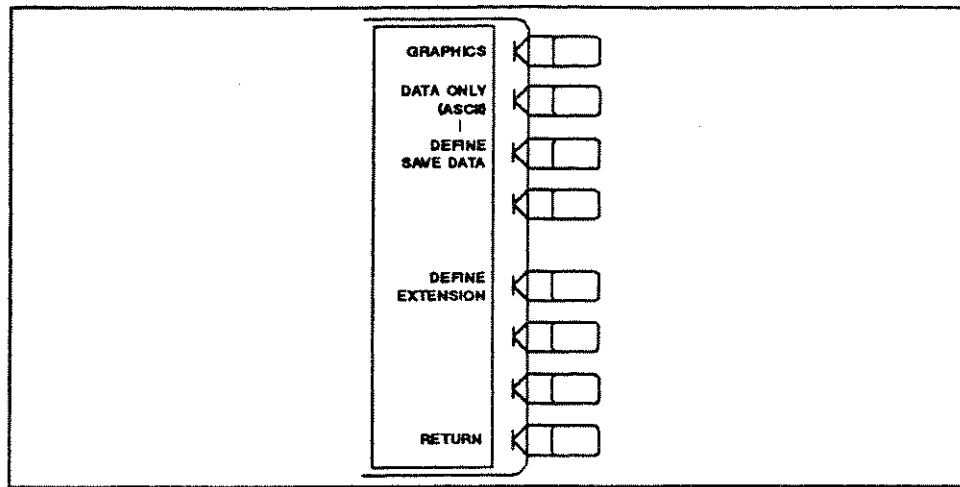

Figure 14-7. ASCII Save Menu

GRAPHICS (SAVDGRA) specifies saving the graphics image on the screen as an HP-GL file. The graphics portion saved is selected in the define plot menu under the **COPY** key. (See Chapter 10.)

DATA ONLY (ASCII) (SAVDASC) specifies saving the internal data arrays as an ASCII file. The arrays saved are defined by the **DEFINE SAVE DATA** key.

DEFINE SAVE DATA provides the define save data menu, which selects the applicable data arrays to be saved.

DEFINE EXTENSION provides the define extension menu, which changes the file extensions of ASCII files.

RETURN returns to the Save menu.

Define Extension Menu

DOS format ASCII default file extensions are changed from this menu. The analyzer stores the changed extensions in its battery backed memory, the changed extensions are saved even when the instrument is turned off.

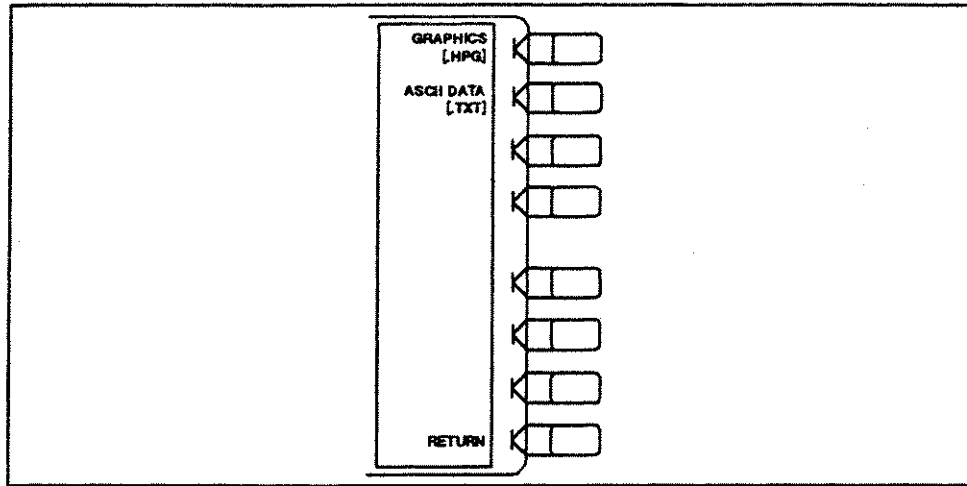

Figure 14-8. Define Extension Menu

GRAPHICS [] (ASCE) changes the extension of HP-GL files for DOS format. The extension is automatically attached to the file name when an HP-GL file is saved. The factory setting is ".HPG".

ASCII DATA [] (GRAE) changes the extension of an ASCII data file for DOS format. The extension is automatically attached to the file name when an ASCII data file is saved. The factory setting is ".TXT".

RETURN returns to the ASCII Save menu.

Define Save Data Menu

This menu defines which data arrays are saved on the disk using the **SAVE DATA ONLY** softkey. See "Internal Data Arrays" for description of each data arrays.

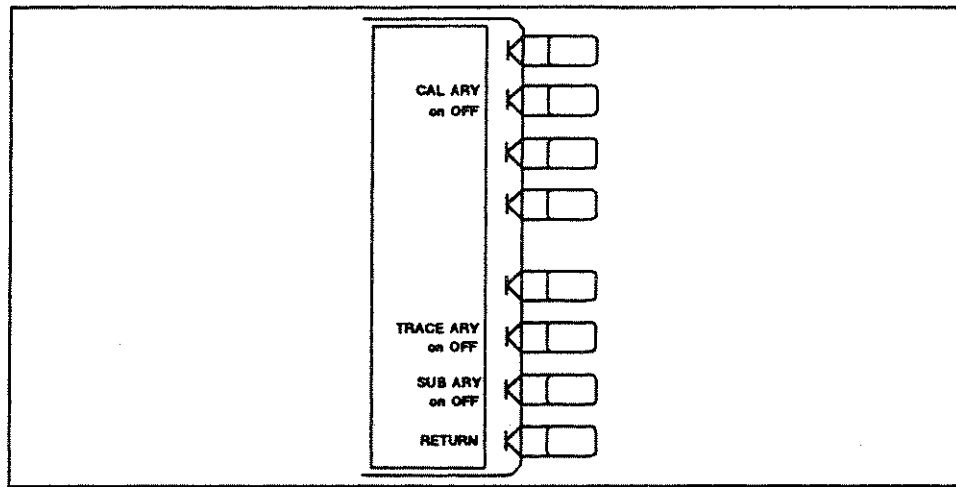

Figure 14-9. Define Save Data Menu

CAL ARY on OFF (SAVCAON, SAVCAOFF) toggles saving or not saving the calibration coefficients arrays.

TRACE ARY on OFF (SAVTAON, SAVTAOFF) toggles saving or not saving the trace arrays.

SUB ARY on OFF (SAVTMAON, SAVTMAOFF) toggles saving or not saving the memory trace arrays.

RETURN returns to the save file menu.

Re-save File Menu

This menu lists the sorted file names, which were previously saved, on the softkey label area and allows updating the file with the current instrument states or data.

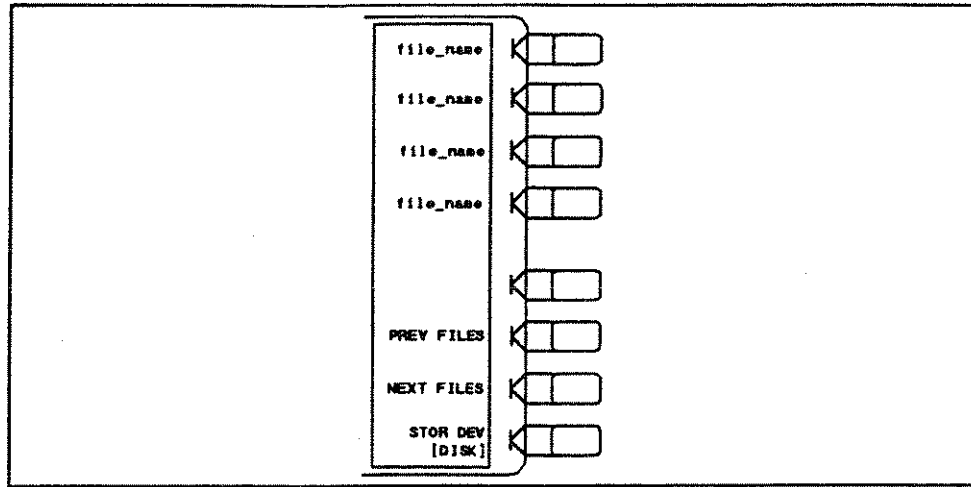

Figure 14-10. Re-save File Menu

file_name updates the file previously saved with the current instrument states or data. The data group to be saved is determined by the file name's extension. See "File Names" for more details about file name extensions.

PREV FILES displays the previous file names in the softkey label to re-save data.

NEXT FILES displays the next file names in the softkey label to re-save data.

STOR DEV (STODDISK STODMEMO) selects between the flexible disk drive and the RAM disk memory as the storage device. **[DISK]** shows the built-in flexible disk is selected and **[MEMORY]** shows the RAM disk memory is selected. This setting does not change even when the line power is cycled or the **PRESET** key is pressed.

Note



For DOS formatted disks, all available files and directories under the current directory are listed. A "\ " is attached at the end of the label if the softkey label shows a directory name.

Pressing a softkey directory listing label changes the current directory to the directory selected, and the files and directories under the new directory are listed.

Disk Menu

This menu provides the Purge File and Initialize menus from which to purge a file and initialize a disk, respectively.

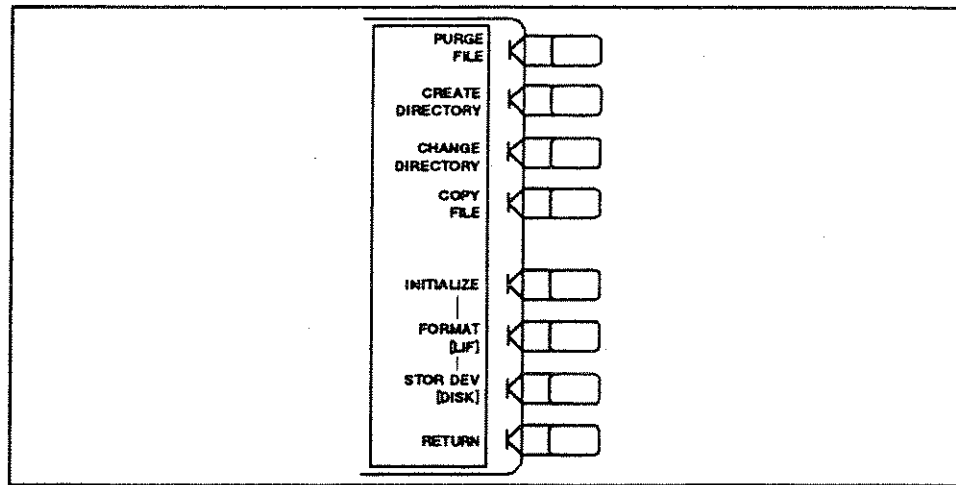

Figure 14-11. Disk Menu

PURGE FILE (PURG) leads to the Purge File menu, from which to remove a file saved on the disk.

CREATE DIRECTORY (CRED) specifies creating a new directory in a DOS format disk. This function is not available for LIF files.

CHANGE DIRECTORY (CHAD) specifies changing the current directory of a DOS format disk. This function is not available for LIF files.

COPY FILE (FILC) leads to the Copy File menu which copies files in the built-in disk drive and the RAM disk memory.

INITIALIZE (INID) leads to the Initialize menu. A new disk must be initialized before data is stored on it. The RAM disk memory also must be initialized at the first time to use or after the power of the backup battery to the RAM disk memory is lost. The disk can be formatted in either LIF or DOS format.

FORMAT [] (INDLIF, INDDOS) selects the disk format to be used when initializing a new disk and the RAM disk memory.

STOR DEV [] (STODDISK STODMEMO) selects between the flexible disk drive and the RAM disk memory as the storage device. **[DISK]** shows the built-in flexible disk is selected and **[MEMORY]** shows the RAM disk memory is selected. This setting does not change even when the line power is cycled or the **[PRESET]** key is pressed.

RETURN returns to the Save menu.

Purge File Menu

This menu lists the sorted file names, which were previously saved, on the softkey label area and allows selecting a file to be removed from the disk.

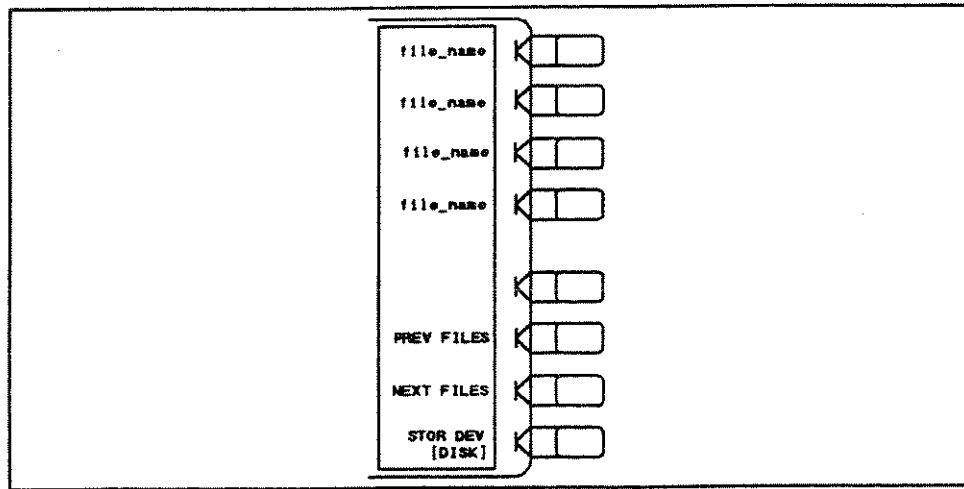

Figure 14-12. Purge File Menu

file_name selects the file name to be removed and provides the purge menu to remove the selected file.

PREV FILES displays set of previous file names in the softkey label area.

NEXT FILES displays next file names in the softkey labels area.

STOR DEV (STODDISK STODMEMO) selects between the flexible disk drive and the RAM disk memory as the storage device. **[DISK]** shows the built-in flexible disk is selected and **[MEMORY]** shows the RAM disk memory is selected. This setting does not change even when the line power is cycled or the **(PRESET)** key is pressed.

Note



All available files and directories under the current directory are listed for DOS format disk. A "\ " is attached at end of the label if the softkey label represents a directory name.

Pressing a softkey listing directory changes the current directory to the directory pressed, the files and directories under the new directory are then listed.

Note



Before recalling a binary data file, set the trigger (under **(MENU)**) to hold to avoid only momentary recall of data.

Purge Menu

This menu confirms the purge operation and removes the selected file.

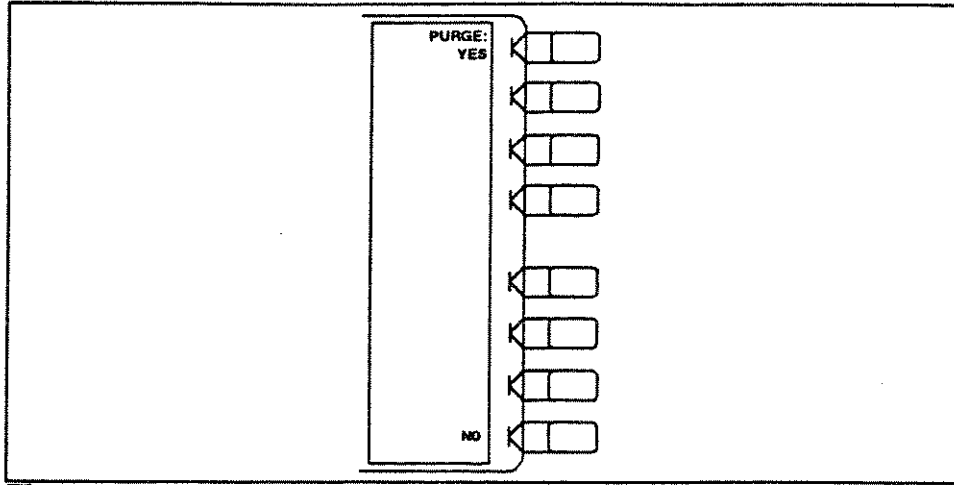

Figure 14-13. Purge Menu

PURGE: YES remove the file and return to the purge file menu.

NO returns to the purge file menu without purging the file.

Initialize Menu

A new disk must be initialized in either the LIF or DOS format before it is used. The initialization format is selected from the Define Format menu.

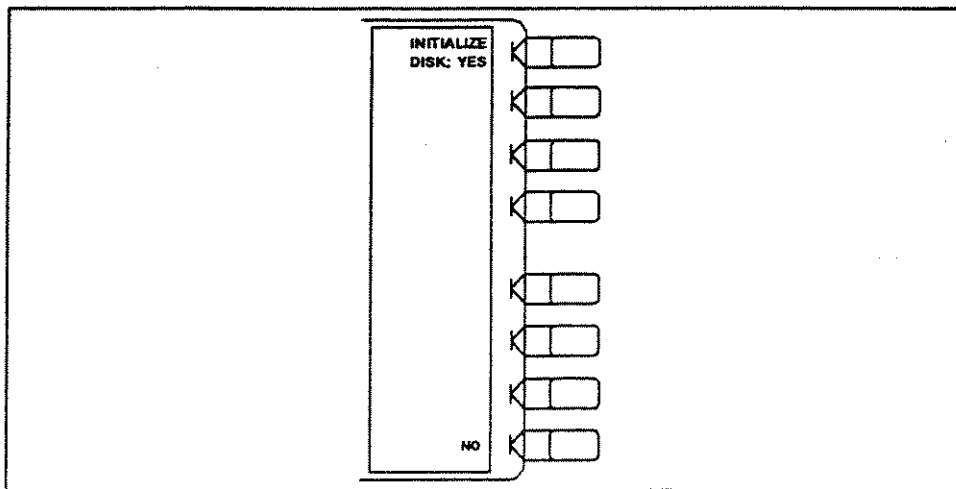

Figure 14-14. Initialize Menu

Caution



If a disk is initialized, all data on the disk is cleared. Be sure no needed data is saved on the disk before initialize a disk.

INITIALIZE YES initializes the disk, then returns to the disk menu.

NO returns to the disk menu without initializing the disk.

Recall File Menu

This menu lists sorted file names, which were previously saved, on the softkey label for selection, and recalls the selected file. The data group to be recalled depends on the file name extension or suffix. See "File Names" for more detail.

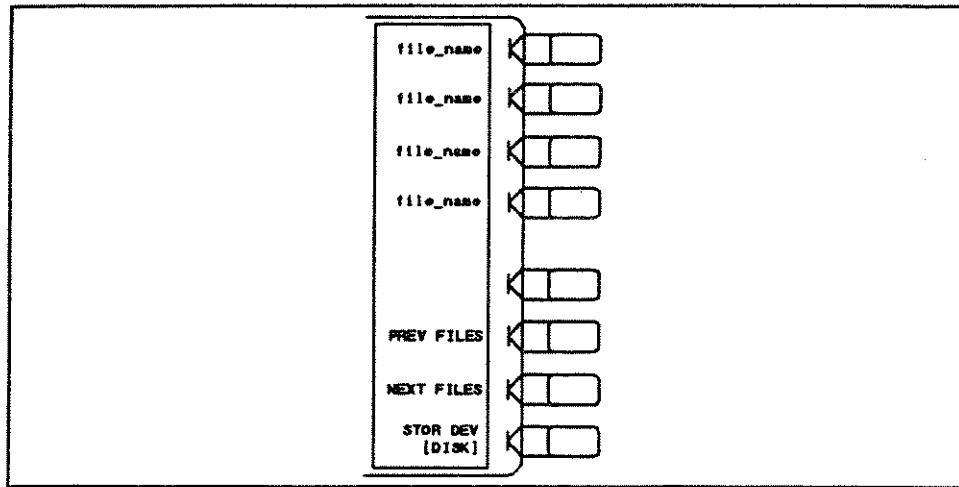

Figure 14-15. Recall File Menu

file_name selects a file to be loaded and loads the instrument state or data.

PREV FILES displays the previous set of file names on the softkey label to load data.

NEXT FILES displays the next set of file names on the softkey label to load data.

STOR DEV (STODDISK for **DISK**, STODMEMO for **MEMORY**) selects between the flexible disk drive and the RAM disk memory as the storage device. **[DISK]** shows the built-in flexible disk is selected and **[MEMORY]** shows the RAM disk memory is selected. This setting does not change even when the line power is cycled or the **[PRESET]** key is pressed.

Note



All available files and directories under the current directory are listed for a DOS formatted disk. A "\ " is attached at end of the label if the softkey label shows a directory name.

Pressing a softkey listing directory changes the current directory to the directory name selected, the files and directories under new directory are then listed.

Copy Menu

This menu lists sorted source file names to copy in the softkey label for selection. When you select a file as the source file, the Destination menu will be displayed. The storage device of the destination file is automatically selected to the other type of storage device for the source file, or you can select a same type of storage device using **STOR DEV**.

The disk formats must be the same between the flexible disk and RAM disk memory, when this copy function copies a file from one device to the other.

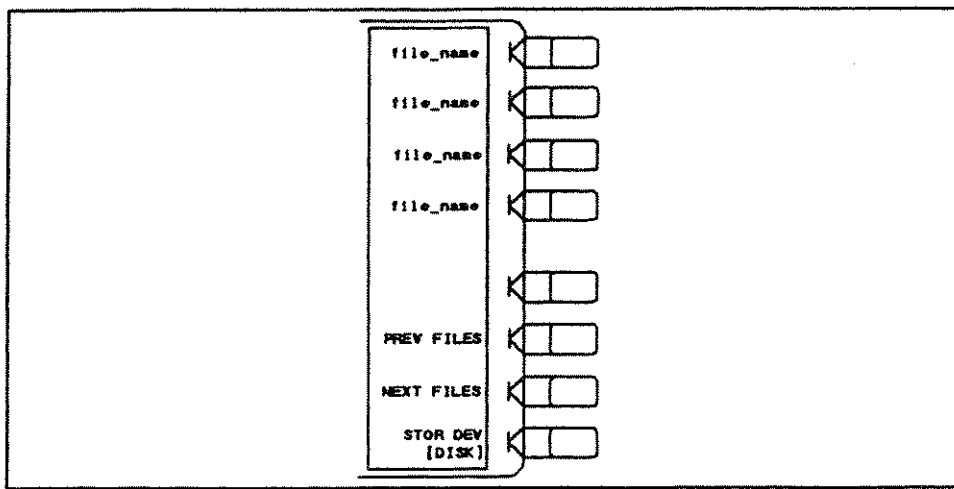

Figure 14-16. Copy Menu

file_name selects a file as the source file to be copied.

PREV FILES displays the previous set of file names on the softkey label to copy files.

NEXT FILES displays the next set of file names on the softkey label to copy files.

STOR DEV[] (STODDISK for **DISK**, STODMEMO for **MEMORY**) selects between the flexible disk drive and the RAM disk memory as the storage device on which the source file is to be stored.

[DISK] shows the built-in flexible disk is selected and **[MEMORY]** shows the RAM disk memory is selected.

Destination Menu

This menu defines destination file names.

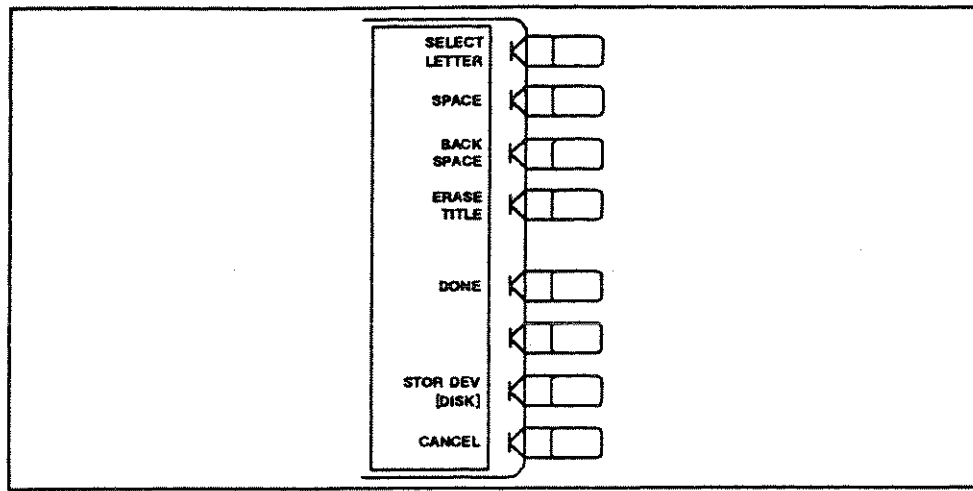

Figure 14-17. Destination Menu

SELECT LETTER The active entry area displays the letters of the alphabet, numerals, etc. To define a destination file name, rotate the knob until the arrow ↑ points to the desired letter, then press **SELECT LETTER**. Repeat this procedure until the file name is defined, for a maximum of eight characters.

SPACE Don't use this key because LIF and DOS file formats don't allow spaces in file names.

BACK SPACE deletes the last character entered.

DONE copies the file specified in the Copy menu to the file specified in the Destination menu.

STOR DEV[] (STODDISK for **DISK**, STODMEMO for **MEMORY**) selects between the flexible disk drive and the RAM disk memory as the storage device a destination file will be stored. **[DISK]** shows the built-in flexible disk is selected and **[MEMORY]** shows the RAM disk memory is selected.

HP-IB Remote Programming

Introduction

The analyzer is factory-equipped with a remote programming digital interface using the Hewlett-Packard Interface Bus (HP-IB). (HP-IB is Hewlett-Packard's hardware, software, documentation, and support for IEEE 488.1, IEC-625, IEEE 488.2, and JIS-C1901 worldwide standards for interfacing instruments.) This allows the analyzer to be controlled by an external computer to send commands or instructions to, and receive data from the HP-IB controlled instrument. In this way, a remote operator has the same control of the instrument available to a local operator using the front panel controls, except for the line power switch.

In addition, the analyzer itself can use HP-IB to directly control compatible peripherals, without the use of an external controller or Instrument BASIC. It can output measurement results directly to a compatible printer or plotter.

This chapter provides an overview of HP-IB operation. Chapter 9 provides information on different controller modes, and on setting up the analyzer as a controller of peripherals. It also explains how to use the analyzer as a controller to print and plot. HP-IB equivalent commands for front panel functions are provided in parentheses throughout this manual.

More complete information on programming the analyzer remotely over HP-IB is provided in *HP-IB Programming Manual*. The *HP-IB Programming Manual* includes examples of remote measurements using an HP 9000 series 200 or 300 computer using the BASIC programming language. The *HP-IB Programming Manual* assumes familiarity with front panel operation of the instrument.

A complete general description of the HP-IB is available in *Tutorial Description of the Hewlett-Packard Interface Bus*, HP publication 5952-0156. For more information on the IEEE 488.1 standard, see *IEEE Standard Digital Interface for Programmable Instrumentation*, published by the Institute of Electrical and Electronics Engineers, Inc., 345 East 47th Street, New York 10017, USA.

How HP-IB Works

The HP-IB uses a party-line bus structure in which up to 15 separately addressable devices can be connected on one contiguous bus. The interface consists of 16 signal lines and 6 grounded lines in a shielded cable. With this cabling system, many different types of devices including instruments, computers, plotters, and printers can be connected in parallel.

Every HP-IB device must be capable of performing one or more of the following interface functions:

Talker

A talker is a device capable of sending device-dependent data when addressed to talk. There can be only one active talker at any given time. Examples of this type of device are voltmeters, counters, and tape readers. The analyzer is a talker when it sends trace data or marker information over the bus.

Listener

A listener is a device capable of receiving device-dependent data when addressed to listen. There can be any number of active listeners at any given time. Examples of this type of device are printers, power supplies, and signal generators. The analyzer is a listener when it is controlled over the bus by a computer.

Controller

A controller is a device capable of managing the operation of the bus and addressing talkers and listeners. There can be only one active controller at any time. Examples of controllers include desktop computers and minicomputers. In a multiple-controller system, active control can be passed between controllers, but there can only be one *system controller*, which acts as the master, and can regain active control at any time. The analyzer is an active controller when it plots or prints in the addressable mode. The analyzer is a system controller when it is in the system controller mode. These modes are discussed in more detail in "HP-IB Menu" in Chapter 12.

HP-IB Requirements

Number of Interconnected Devices:	15 maximum.
Interconnection Path/ Maximum Cable Length:	20 meters maximum or 2 meters per device, whichever is less.
Message Transfer Scheme:	Byte serial/bit parallel asynchronous data transfer using a 3-line handshake system.
Data Rate:	Maximum of 1 megabyte per second over limited distances with tri-state drivers. Actual data rate depends on the transfer rate of the slowest device involved.
Address Capability:	Primary addresses: 31 talk, 31 listen. A maximum of 1 active talker and 14 active listener at one time.
Multiple Controller Capability:	In systems with more than one controller (like the analyzer system), only one can be active at any given time. The active controller can pass control to another controller, but only one system controller is allowed.

Analyzer HP-IB Capabilities

As defined by the IEEE 488.1 standard, the analyzer has the following capabilities:

SH1	Full source handshake.
AH1	Full acceptor handshake.
T6	Basic talker, answers serial poll, unaddresses if MLA is issued. No talk-only mode.
L4	Basic listener, unaddresses if MTA is issued. No listen-only mode.
SR1	Complete service request (SRQ) capabilities.
RL1	Complete remote/local capability including local lockout.
PP0	Does not respond to parallel poll.
DC1	Complete device clear.
DT1	Responds to a group execute trigger.
C1, C2, C3	System controller capabilities in system controller mode.
C11	Pass control capabilities in addressable mode.
E2	Tri-state drivers.

Bus Mode

The analyzer uses a single-bus architecture. The single bus allows both the analyzer and the host controller to have complete access to the peripherals in the system.

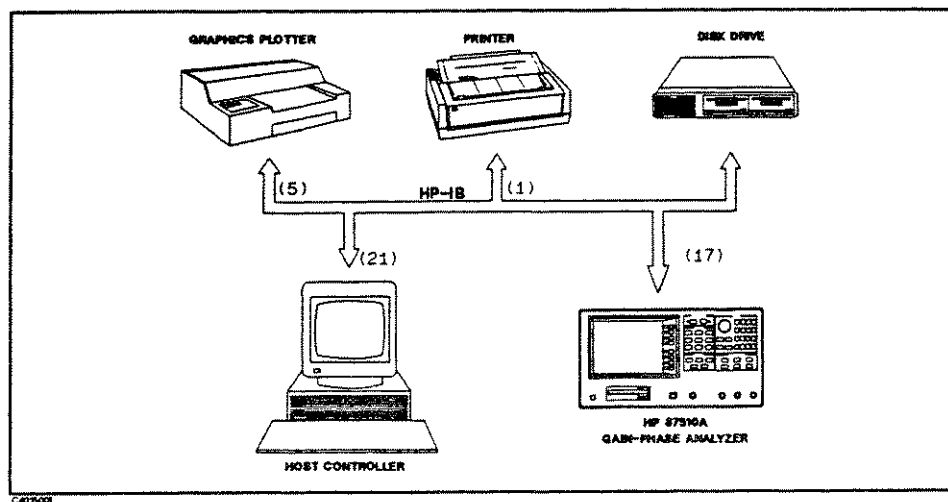

Figure 15-1. Analyzer Single Bus Concept

Two different modes are possible, system controller, and addressable.

System Controller	This mode allows the analyzer to control peripherals directly in a stand-alone environment (without an external controller). This mode can only be selected manually from the analyzer front panel. Use this mode for operation when no computer is connected to the analyzer. Printing and plotting use this mode.
-------------------	---

Addressable This is the traditional programming mode, in which the computer is involved in all peripheral access operations. When the external controller is connect the analyzer through HP-IB (as shown in Figure 15-1), this mode allows you to control the analyzer over HP-IB in the talker mode in order to send data, and in the listener mode to receive commands, and also allows the analyzer to take or pass control in order to plot and print.

Chapter 9 explains the two different bus modes in detail, and provides information on setting the correct bus mode. Programming information for the addressable mode is provided in the *HP-IB Programming Manual*.

Setting Addresses

In communications though HP-IB, each instrument on the bus is identified by an HP-IB address. This address code must be different for each instrument on the bus. See "Address Menu" in Chapter 12 for information on default addresses, and on setting and changing addresses. These addresses are not affected when you press **PRESET** or cycle the power.

Manual Changes

Introduction

This appendix contains the information required to adapt this manual to earlier versions or configurations of the HP 87510A than the current printing date of this manual. The information in this manual applies directly to the HP 87510A Gain-Phase Analyzer serial number prefix listed on the title page of this manual.

Manual Changes

To adapt this manual to your HP 87510A, *see* Table A-1 and Table A-2, and make all of the manual changes listed opposite your instrument's serial number and firmware version.

Instruments manufactured after the printing of this manual may be different than those documented in this manual. Later instrument versions will be documented in a manual changes supplement that will accompany the manual shipped with that instrument. If your instrument's serial number is not listed on the title page of this manual or in Table A-1, it may be documented in a *yellow MANUAL CHANGES* supplement.

Turn on the instrument or execute the "*IDN?" HP-IB command to confirm the firmware version. *See* the HP-IB Programming Manual for information on the "*IDN?" command. For additional information on serial number coverage, *see* Chapter 2. *

Table A-1. Manual Changes by Serial Number

Serial Prefix or Number	Make Manual Changes
	There are no earlier configurations than the printing date of this manual

Table A-2. Manual Changes by Firmware Version

Version	Make Manual Changes
	There are no earlier versions than the printing date of this manual.



Default

Preset State

When the **PRESET** key is pressed, or the analyzer is turned on, the analyzer reverts to a known state. There are subtle differences between the preset state and the power-up state, and these states are defined in Table B-1 to Table B-5.

Some power-up states are recalled from non-volatile memory (battery backup memory). If power to the non-volatile memory is lost, the analyzer will have certain parameters set to factory settings. Table B-7 lists the factory settings. The operating time of the battery backup memory is approximately 72 hours. The battery is automatically recharged while the instrument is ON. The recharge time (time required to fully recharge the battery) is approximately 10 minutes.

When line power is cycled the analyzer performs a self-test routine. Upon successful completion of the self-test routine, the instrument state is set to the following preset conditions. The same conditions are true following a "PRES" or "*RST" command over the HP-IB bus.

Table B-1. Preset Conditions

Operating Parameter	Initialization Method	
	Power-On	PRESET key
Stimulus Conditions		
Sweep Type	Linear frequency	Linear Frequency
Display Mode	Start/Stop	Start/Stop
Trigger Type	Continuous	Continuous
External Trigger	OFF	OFF
Sweep Time	50.25 ms	50.25 ms
Start Frequency	100 kHz	100 kHz
Frequency Span	299.9 MHz	299.9 MHz
Source Power	0 dBm	0 dBm
Power trip	Clear	Clear
Coupled Channels	ON	ON
Frequency List		
Frequency List	Empty	Empty
Edit Mode	Start/Stop, Number of Points	Start/Stop, Number of Points

Table B-2. Preset conditions

Operating Parameter	Initialization Method	
	Power-On	(PRESET) key
Response Conditions		
Parameter		
Channel 1	A/R	A/R
Channel 2	A/R	A/R
Conversion	OFF	OFF
Format	Log magnitude (all inputs)	Log magnitude (all inputs)
Display	Data	Data
Dual Channel	OFF	OFF
Active Channel	Channel 1	Channel 1
Frequency Blank	Disabled	Disabled
Split Display	ON	ON
Intensity	83 %	No effect (same as before preset)
Background Intensity	0 %	No effect (same as before preset)
Color Selections		
Channel 1 Data	Yellow	No effect (same as before preset)
Channel 1 Sub	Green	No effect (same as before preset)
Channel 2 Data	Blue	No effect (same as before preset)
Channel 2 Sub	Pink	No effect (same as before preset)
Graticule	Gray	No effect (same as before preset)
Warning	Red	No effect (same as before preset)
Text	White	No effect (same as before preset)
Beeper:Done	ON	ON
Beeper:Warning	OFF	OFF
Title	Empty	Empty
Number of Points	201	201
IF Bandwidth	8 kHz	8 kHz
IF Averaging Factor	16; OFF	16; OFF
Smoothing Aperture	1% Span; OFF	1% Span; OFF
Group Delay Aperture	1% Span	1% Span
Phase Offset	0°	0°
Electrical Delay	0 s	0 s
Conjugate Matching	OFF	OFF

Table B-3. Preset conditions

Operating Parameter	Initialization Method	
	Power-On	PRESET key
Calibration		
Correction	OFF	OFF
Calibration Type	None	None
Calibration Kit	7 millimeter	7 millimeter
System Impedance	50 Ω	50 Ω
Velocity Factor	1	1
Extensions	OFF	OFF
Input R	0 s	0 s
Input A	0 s	0 s
Scale		
Log Magnitude	10 dB	10 dB
Phase	90°	90°
Group Delay	10 nsec	10 nsec
Polar Chart	1	1
Linear Magnitude	0.1	0.1
Real	0.2	0.2
Imaginary	0.2	0.2
Reference Line Position		
Log Magnitude	5 dB	5 dB
Phase	5°	5°
Group Delay	5 nsec	5 nsec
Polar Chart	-	-
Linear Magnitude	0	0
Real	5	5
Imaginary	5	5
Reference Value		
Log Magnitude	0 dB	0 dB
Phase	0°	0°
Group Delay	0 nsec	0 nsec
Polar Chart	1	1
Linear Magnitude	0	0
Real	0	0
Imaginary	0	0

Table B-4. Preset conditions

Operating Parameter	Initialization Method	
	Power-On	(PRESET) key
Markers		
Markers 1,2,3,4,5,6,7,8	100 kHz all markers off	100 kHz all markers off
Markers ON	Data	Data
Active Marker	1	1
Reference Marker	None	None
Marker Mode	Continuous	Continuous
Delta Marker Mode	OFF	OFF
Coupling	ON	ON
Marker List	OFF	OFF
Marker Time	OFF	OFF
Marker Search	OFF	OFF
Marker Target Value	-3 dB	-3 dB
Marker Width Value	-3 dB; OFF	-3 dB; OFF
Marker Tracking	OFF	OFF
Marker Stimulus Offset	0 Hz	0 Hz
Marker Value Offset	0 dB	0 dB
Marker Aux Offset (Phase)	0°	0°
Marker Statistics	OFF	OFF
Polar Marker	LIN MKR	LIN MKR
Limit Lines		
Limit Lines	OFF	OFF
Limit Testing	OFF	OFF
Limit Line Table	Clear	No effect (Same as before preset)
Edit Mode	Upper/Lower Limits	Upper/Lower Limits
Stimulus Offset	0 Hz	0 Hz
Amplitude Offset	0 dB	0 dB
Beep Fail	OFF	OFF
BIN Sort		
BIN Sort Line	OFF	OFF
BIN Sort Test	OFF	OFF
Output I/O Port	Port A	Port A
BIN Sort Table	Empty	Empty

Table B-5. Preset conditions

Operating Parameter	Initialization Method	
	Power-On	PRESET key
System Parameters		
HP-IB Addresses	Battery backup memory	No effect (same as before preset)
HP-IB Mode	Battery backup memory	No effect (same as before preset)
Plot		
Copy Time	OFF	OFF
Define Plot	All	All
Plot Quadrant	Full page	Full page
Scale Plot	Full	Full
Plot Speed	Fast	Fast
Line Type for Data	7 (solid)	7 (solid)
Line Type for Memory	7 (solid)	7 (solid)
Print	Standard	Standard

Table B-6. Preset Conditions

Operating Parameter	Initialization Method	
	Power-On	PRESET key
Waveform Analysis		
Analysis range	Full	Full
Analysis data	CH1	CH1
Disk Format		
Format	LIF	LIF
Parallel I/O		
Direction of Port C and D	Input	No effect (Same as before preset)
Positive and Negative Logic Setting	Negative	No effect (Same as before preset)
OUTPUT1 and 2 output level	High	No effect (Same as before preset)

Table B-7.
Results of Power Loss to Battery Backup Memory (Factory Setting)

Parameter	Factory Setting
HP-IB Address, HP 8751A	17
HP-IB Address, Plotter	5
HP-IB Address, Printer	1
HP-IB Address, Controller	21
DC Detect or Calibration Coefficients	Reset
Calibration Kit Definitions	Factory set default (See Table B-8 to Table B-13.)
Real Time Clock	1991.1.1
Extension name, ASCII data file	.TXT
Extension name, HP-GL file	.HPG

Predefined Calibration Kit

Predefined Standards

Table B-8. 7 mm Standard Cal Kit

NO.	STANDARD TYPE	C0 $\times 10^{-15}F$	C1 $\times 10^{-27}F/Hz$	C2 $\times 10^{-36}F/Hz^2$	OFFSET DELAY ps	OFFSET LOSS M Ω /s	OFFSET Z ₀ Ω	STANDARD LABEL
1	SHORT				0	700	50	SHORT
2	OPEN	92.85	0	7.2	0	700	50	OPEN
3	LOAD				0	700	50	BROADBAND
4	DELAY/THRU				0	700	50	THRU
5	LOAD				0	700	50	SLIDING
6	LOAD				0	700	50	LOWBAND
7	SHORT				0	700	50	
8	OPEN	79.4	0	40	0	700	50	OPEN

Table B-9. 50 Ω Type-N Standard Cal Kit

NO.	STANDARD TYPE	C0 $\times 10^{-15}\text{F}$	C1 $\times 10^{-27}\text{F/Hz}$	C2 $\times 10^{-36}\text{F/Hz}^2$	OFFSET DELAY ps	OFFSET LOSS MΩ/s	OFFSET Z_0 Ω	STANDARD LABEL
1	SHORT				0	700	50	SHORT[M]
2	OPEN	108	55	130	0	700	50	OPEN[M]
3	LOAD				0	700	50	BROADBAND
4	DELAY/THRU				0	700	50	THRU
5	LOAD				0	700	50	SLIDING
6	LOAD				0	700	50	LOWBAND
7	SHORT				17.544	700	50	SHORT[F]
8	OPEN	62	17	28	17.544	700	50	OPEN[F]

Table B-10. 75 Ω Type-N Standard Cal Kit

NO.	STANDARD TYPE	C0 $\times 10^{-15}\text{F}$	C1 $\times 10^{-27}\text{F/Hz}$	C2 $\times 10^{-36}\text{F/Hz}^2$	OFFSET DELAY ps	OFFSET LOSS MΩ/s	OFFSET Z_0 Ω	STANDARD LABEL
1	SHORT				0	1.13×10^3	75	SHORT[M]
2	OPEN	63.5	84	56	0	1.13×10^3	75	OPEN[M]
3	LOAD				0	1.13×10^3	75	BROADBAND
4	DELAY/THRU				0	1.13×10^3	75	THRU
5	LOAD				0	1.13×10^3	75	SLIDING
6	LOAD				0	1.13×10^3	75	LOWBAND
7	SHORT				17.544	1.13×10^3	75	SHORT[F]
8	OPEN	41	40	5	17.544	1.13×10^3	75	OPEN[F]

Predefined Standard Class Assignments

Table B-11. Standard Class Assignments Table (7 mm)

CLASS	A	B	C	D	E	F	G	STANDARD CLASS LABEL
S _{11A}	2							OPEN
S _{11B}	1							SHORT
S _{11C}	3							LOAD
S _{22A}	2							OPEN
S _{22B}	1							SHORT
S _{22C}	3							LOAD
Forward Transmission	4							THRU
Reverse Transmission	4							THRU
Forward Match	4							THRU
Reverse Match	4							THRU
Response	1	2	4					RESPONSE
Response & Isolation	1	2	4					RESPONSE

Table B-12. Standard Class Assignments Table (50 Ω Type-N)

CLASS	A	B	C	D	E	F	G	STANDARD CLASS LABEL
S _{11A}	2	8						OPENS
S _{11B}	1	7						SHORTS
S _{11C}	3							LOAD
S _{22A}	2	8						OPENS
S _{22B}	1	7						SHORTS
S _{22C}	3							LOAD
Forward Transmission	4							THRU
Reverse Transmission	4							THRU
Forward Match	4							THRU
Reverse Match	4							THRU
Response	1	7	2	8	4			RESPONSE
Response & Isolation	1	7	2	8	4			RESPONSE

Table B-13. Standard Class Assignments Table (75 Ω Type-N)

CLASS	A	B	C	D	E	F	G	STANDARD CLASS LABEL
S _{11A}	2	8						OPENS
S _{11B}	1	7						SHORTS
S _{11C}	3							LOAD
S _{22A}	2	8						OPENS
S _{22B}	1	7						SHORTS
S _{22C}	3							LOAD
Forward Transmission	4							THRU
Reverse Transmission	4							THRU
Forward Match	4							THRU
Reverse Match	4							THRU
Response	1	7	2	8	4			RESPONSE
Response & Isolation	1	7	2	8	4			RESPONSE

6

6

6

Parallel I/O (STANDARD and OPTION 006)

Using a parallel I/O port on the rear panel of HP 87510A enables information communication with external devices such as a handler on a production line.

Note



There are three types of parallel I/O ports: a standard parallel I/O port and two optional parallel I/O ports (Options 005 and 006). Two or more parallel I/O ports cannot be used at the same time. Appendix C explains the standard parallel I/O port and Option 006 Parallel I/O Mode B. For optional parallel I/O port (Option 005 Parallel I/O Mode A), *see* Appendix D.

The parallel I/O port consists of four independent parallel input/output ports, some control signal lines, and a power supply line. Since all signals are TTL-compatible, data input/output ports consist of two 8-bit output ports and two 4-bit bidirectional ports. Using these ports simultaneously provides a 24-bit maximum bandwidth output port or an 8-bit maximum bandwidth input port. Input/output signals are factory-set to negative logic. They can be reset to positive logic using an HP-IB command. The control signal lines consist of sweep end output, limit testing result (PASS/FAIL) output, and hand-shaking control signal input/output lines.

HP-IB commands are used to control the parallel I/O ports. These HP-IB commands are summarized at the end of this Appendix.

This Appendix describes the following:

- Input/Output Ports
- Control Signal Lines
- Parallel I/O Port Pin Definition
- HP-IB Commands for Controlling Parallel I/O Ports

I/O Ports

The HP 87510A has two output ports and two bidirectional ports.

- Output-Only Port
 - Port A: 8 bits wide
 - Port B: 8 bits wide

Signals are output from latches at the TTL level. When BIN sort testing is turned ON, the BIN sort testing result is output. (Related HP-IB commands: OUTAIO, OUTBIO, BINOA, and BINOB)

- Bidirectional ports
 - Port C: 4 bits wide
 - Port D: 4 bits wide

Output signals (latch output signals) are TTL-compatible. Use an HP-IB command to switch between input/output directions. When the HP 87510A is turned ON, both ports C and D are defined as input ports. (Related HP-IB commands: OUTCIO, OUTDIO, OUTPINPCIO?, and OUTPINPDIO?)

Combining the above ports using HP-IB commands provides the following four different ports:

- Bidirectional Port
 - Port E: 8 bits wide (Port C + Port D)
- Output Ports
 - Port F: 16 bits wide (Port A + Port B)
 - Port G: 20 bits wide (Port A + Port B + Port C)
 - Port H: 24 bits wide (Port A + Port B + Port C + Port D)

Control Signal Lines

I/O ports include nine types (10 types for Option 006) of output signal lines and one input signal line. Control signals are TTL-compatible (excluding the power supply line). These signals are described below.

Port C Status Output Signal or Port D Status Output Signal

This signal is set at the low level when port C or D is defined as an input port. It is set at the high level when port C or D is defined as an output port. This signal is used to report the direction (input or output) of port C or D to external devices. (Related HP-IB commands: CIN, COUNT, DIN, and DOUT)

WRITE STROBE Output Signal for Output Port

When data is output to any output port, a negative pulse is output to WRITE STROBE OUTPUT. This negative output pulse notifies external devices of output to the parallel I/O port. Figure C-1 shows the write strobe output signal and data output timing.

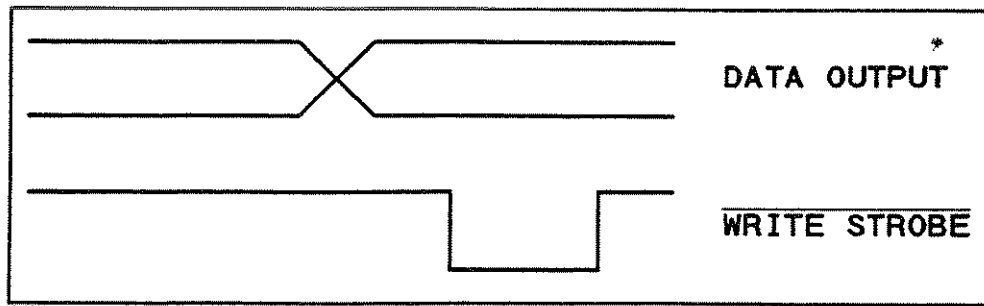

Figure C-1. Write strobe signal timing chart

INPUT1 Input Signal

When a negative pulse is input to INPUT1, OUTPUT1, and OUTPUT2 are set at the low or high level. An HP-IB signal is used to determine whether the high or low level is to be set. The width of the signal input to INPUT1 must be 1 μ s or more. (Related HP-IB commands: OUT1ENVH, OUT1ENVL, OUT2ENVH, and OUT2ENVL)

OUTPUT1 Output Signal or OUTPUT2 Output Signal

This signal (latch output signal) can be set at the low or high level by inputting a negative pulse to INPUT1 or using an HP-IB command. (Related HP-IB commands: OUT1H, OUT1L, OUT2H and OUT2L)

PASS/FAIL Output Signal

This signal is set at the high level when the limit testing result is OK (PASS). It is set at the low level when the test result is NG (FAIL). This signal is effective only when the limit test function is ON.

WRITE STROBE Output Signal for PASS/FAIL Output

When the limit testing result is output to the PASS/FAIL output line, a negative pulse is output to WRITE STROBE OUTPUT. This output signal notifies external devices of the limit testing result output to the PASS/FAIL OUTPUT.

SWEEP END Output Signal

When the HP 87510A completes a sweep, a negative pulse is output. The pulse width is 10 μ s.

A +5 V output pin is provided for an external device. A maximum of 100 mA current may be supplied. This line has no phase. However, if an excess current flows, a protective circuit functions to cut off the main power of the HP 87510A. When the overcurrent subsides, the main power is turned ON again. In this case, all device settings are initialized.

Figure C-2 shows the schematic drawing of input/output ports and control signal lines.

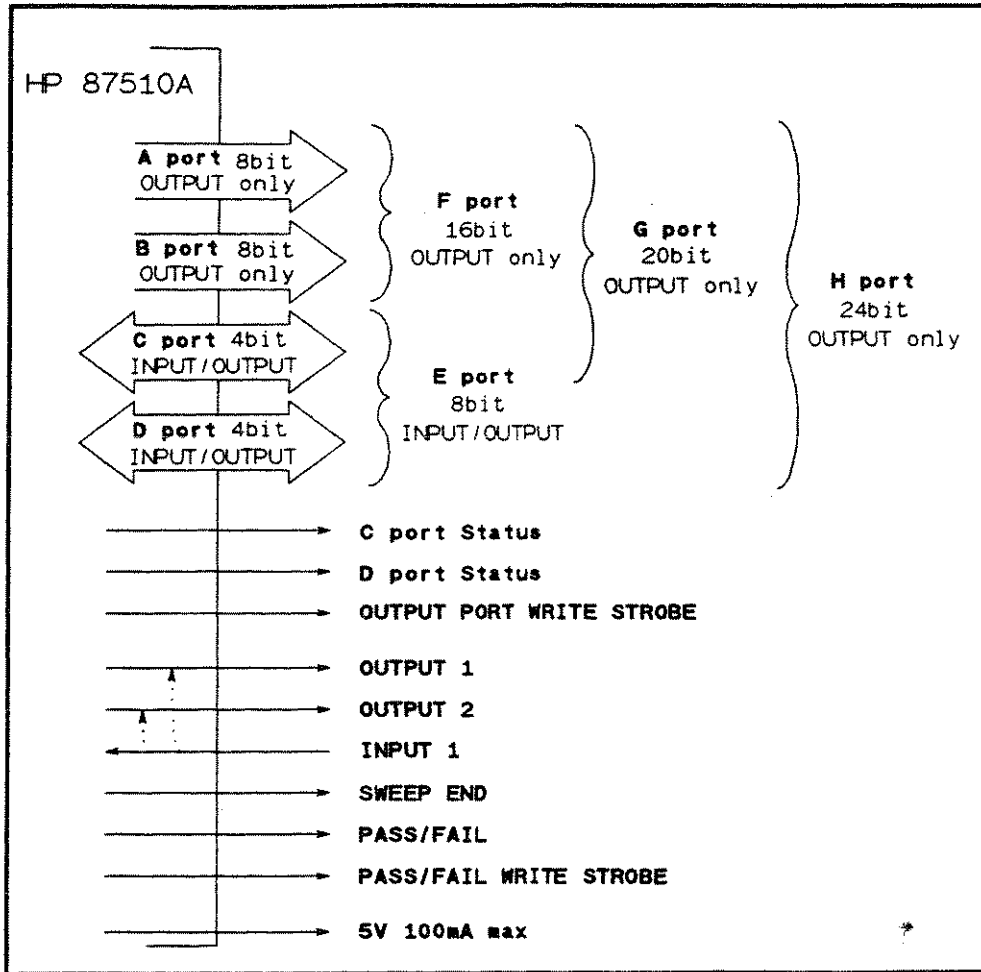

Figure C-2. Schematic Drawing of Parallel I/O Ports

Pin Assignment

Figure C-2 shows pin numbers. Table C-1 shows assignment of signals to pins.

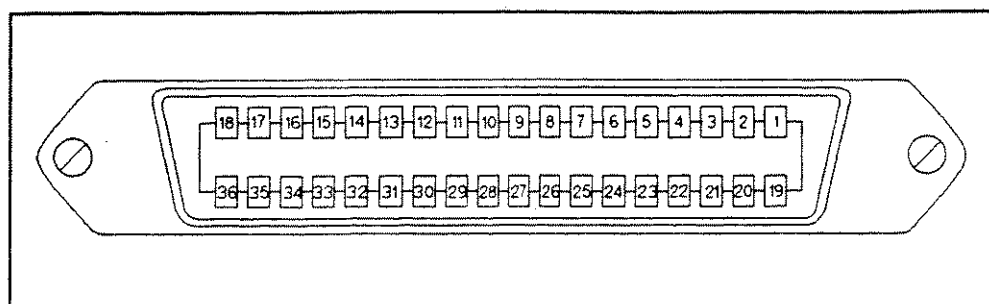

Figure C-3. Parallel I/O Port Connector Pin Numbers

Table C-1. Assignment of Signals to Pins (Standard)

Pin No.	Signal Name	Signal Standard
1	GND	0 V
2	INPUT1	TTL level, Pulse input, Pulse width of 1 μ s or more
3	OUTPUT1	TTL level, Latch output
4	OUTPUT2	TTL level, Latch output
5	Output port A0	TTL level, Latch output
6	Output port A1	TTL level, Latch output
7	Output port A2	TTL level, Latch output
8	Output port A3	TTL level, Latch output
9	Output port A4	TTL level, Latch output
10	Output port A5	TTL level, Latch output
11	Output port A6	TTL level, Latch output
12	Output port A7	TTL level, Latch output
13	Output port B0	TTL level, Latch output
14	Output port B1	TTL level, Latch output
15	Output port B2	TTL level, Latch output
16	Output port B3	TTL level, Latch output
17	Output port B4	TTL level, Latch output
18	Output port B5	TTL level, Latch output
19	Output port B6	TTL level, Latch output
20	Output port B7	TTL level, Latch output
21	Input/output port C0	TTL level, Latch output
22	Input/output port C1	TTL level, Latch output
23	Input/output port C2	TTL level, Latch output
24	Input/output port C3	TTL level, Latch output
25	Input/output port D0	TTL level, Latch output
26	Input/output port D1	TTL level, Latch output
27	Input/output port D2	TTL level, Latch output
28	Input/output port D3	TTL level, Latch output
29	Port C status	TTL level, Input mode: Low, Output mode: High
30	Port D status	TTL level, Input mode: Low, Output mode: High
31	Write strobe signal	TTL level, Negative logic, Pulse output
32	+5 V pull-up	
33	PASS/FAIL signal	TTL level, PASS: High, FAIL: Low, Latch output
34	+5 V	+5 V, 100 mA max.
35	SWEEP END signal	TTL level, Negative logic, Pulse output (Width: 10 μ s or more)
36	Write strobe signal	TTL level, Negative logic, Pulse (for PASS/FAIL) output

Table C-2. Assignment of Signals to Pins (Option 006)

Pin No.	Signal Name	Signal Standard
1	GND	0 V
2	INPUT1	TTL level, Pulse input, Pulse width of 1 μ s or more
3	OUTPUT1	TTL level, Latch output
4	OUTPUT2	TTL level, Latch output
5	Output port A0	TTL level, Latch output
6	Output port A1	TTL level, Latch output
7	Output port A2	TTL level, Latch output
8	Output port A3	TTL level, Latch output
9	Output port A4	TTL level, Latch output
10	Output port A5	TTL level, Latch output
11	Output port A6	TTL level, Latch output
12	Output port A7	TTL level, Latch output
13	Output port B0	TTL level, Latch output
14	Output port B1	TTL level, Latch output
15	Output port B2	TTL level, Latch output
16	Output port B3	TTL level, Latch output
17	Output port B4	TTL level, Latch output
18	Not used	
19	Output port B5	TTL level, Latch output
20	Output port B6	TTL level, Latch output
21	Output port B7	TTL level, Latch output
22	Input/output port C0	TTL level, Latch output
23	Input/output port C1	TTL level, Latch output
24	Input/output port C2	TTL level, Latch output
25	Input/output port C3	TTL level, Latch output
26	Input/output port D0	TTL level, Latch output
27	Input/output port D1	TTL level, Latch output
28	Input/output port D2	TTL level, Latch output
29	Input/output port D3	TTL level, Latch output
30	Port C status	TTL level, Input mode:Low, Output mode:High
31	Port D status	TTL level, Input mode:Low, Output mode:High
32	Write strobe signal	TTL level, Negative logic, Pulse output
33	PASS/FAIL signal	TTL level, PASS:High, FAIL: Low, Latch output
34	SWEEP END signal	TTL level, Negative logic, Pulse output (Width:10 μ s or more)
35	+5 V	+5 V, 100 mA max.
36	Write strobe signal	TTL level, Negative logic, Pulse output

HP-IB Commands for Parallel I/O Port Control

The HP-IB commands related to parallel I/O ports are summarized below. For more information on HP-IB commands, see the *HP-IB Programming Manual*.

Note



The HP-IB commands summarized below are used to control the standard Parallel I/O and Option 006. For the HP-IB commands related to Option 005 (8-bit I/O), see Appendix D.

Data Output Commands

The following commands output data to the corresponding ports (A to H). When ports C, D, E, F, G, and H are used as output ports, ports C and D must be defined as output ports using HP-IB commands (COUT and DOUT).

- OUTAIO outputs 8-bit data to port A.
- OUTBIO outputs 8-bit data to port B.
- OUTCIO outputs 4-bit data to port C.
- OUTDIO outputs 4-bit data to port D.
- OUTEIO outputs 8-bit data to port E.
- OUTFIO outputs 16-bit data to port F.
- OUTGIO outputs 20-bit data to port G.
- OUTHIO outputs 24-bit data to port H.

Data Input Commands

The following commands read data from the corresponding input ports (C to E) and returns the values to the HP-IB. Before receiving data, ports C and D must be defined as input ports using HP-IB commands (CIN and DIN).

- OUTPINPCIO? reads 4-bit data from port C and returns its value to the HP-IB.
- OUTPINPDIO? reads 4-bit data from port D and returns its value to the HP-IB.
- OUTPINPEIO? reads 8-bit data from port E and returns its value to the HP-IB.

Commands for Setting Input/Output Directions of Ports C and D

The following commands set the input/output directions of ports C and D. When the power is turned ON, ports C and D are defined as input ports. Pressing **PRESET** key do not affect this setting. This setting is saved to an instrument state file using the Save function.

- CIN defines port C as an input port.
- COUT defines port C as an output port.
- DIN defines port D as an input port.
- DOUT defines port D as an output port.

Positive and Negative Logic Setting Commands

The following commands set positive or negative logic for port input/output signals. When the power is turned ON, negative logic is set. Pressing **PRESET** key do not affect this setting. This setting is saved to an instrument state file using the Save function.

- NEGL sets negative logic.
- POSL sets positive logic.

OUTPUT1 and OUTPUT2 Level Setting Commands

The following commands set OUTPUT1 and OUTPUT2 levels:

- OUT1H sets OUTPUT1 at the high level.
- OUT1L sets OUTPUT1 at the low level.
- OUT2H sets OUTPUT2 at the high level.
- OUT2L sets OUTPUT2 at the low level.

Commands for Setting OUTPUT1 and OUTPUT2 at the High or Low Level upon input of a Pulse to INPUT1

The following commands set OUTPUT1 and OUTPUT2 at the high or low when a negative pulse is input to INPUT1. When the power is turned ON, both OUTPUT1 and OUTPUT2 are set at the high level. Pressing **PRESET** key do not affect this setting. This setting is saved to an instrument state file using the Save function.

- OUT1ENVH sets OUTPUT1 at the high level when a pulse is input to INPUT1.
- OUT1ENVL sets OUTPUT1 at the low level when a pulse is input to INPUT1.
- OUT2ENVH sets OUTPUT2 at the high level when a pulse is input to INPUT1.
- OUT2ENVL sets OUTPUT2 at the low level when a pulse is input to INPUT1.

Command for Checking Input to INPUT1

This command checks whether a pulse has been input to INPUT1. Sending this command after a pulse is input to INPUT1 will return a HIGH. If no pulse has been input to INPUT1, the return values will be LOW. After HIGH is received, succeeding values will be cleared. (set to LOW)

D

Option 005 Parallel I/O Mode A (8-bit)

This appendix provides information on the HP 87510A with Option 005 Parallel I/O Mode A (8-bit I/O port).

I/O Port

The I/O port on the analyzer rear panel communicates with the external devices such as a handler on a production line.

Pin Assignment

The 8-bit I/O port consists of 15 TTL compatible signals, which are 8-bit output, 4-bit input, sweep end, pass/fail, and ground. The pin assignments are shown in Figure D-1.

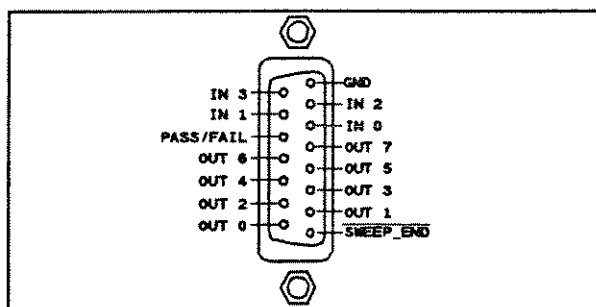

Figure D-1. 8-bit I/O Port Pin Assignments

The signals carried through each pin are described below.

SWEEP_END	outputs a negative pulse when the analyzer completes a sweep. The pulse width is $> 10 \mu\text{s}$.
OUT 0 thru 7	output signals to external devices and are controlled by two HP-IB commands, OUT8IO, as described below. Once OUT8IO is executed, the signal is latched until OUT8IO is executed again.
IN 0 thru 4	input signals from external devices and are read by the HP-IB command INP8IO, as described below.
PASS/FAIL	is affected only when the Limit Testing, described in "Limit Line and Limit Testing" in Chapter 12, is active. This signal presents HIGH and LOW if the test result is PASS and FAIL, respectively.

Related HP-IB Commands

There are three HP-IB commands which directly control an I/O port.

- OUT8IO** outputs 8-bit data to the OUT 0 thru 7 lines. The OUT 0 signal is the LSB (least significant bit), while the OUT 7 signal is the MSB (most significant bit).
- INP8IO** inputs 4-bit data from the IN 0 thru 3 signals to the analyzer's memory. The IN 0 signal is the LSB (least significant bit), while the IN 3 signal is the MSB (most significant bit).
- INP8IO?** inputs data from the 4-bit parallel input port to the HP 87510A, and outputs the data to the controller.
- OUTPINP8IO?** is a query command which outputs 8-bit data to the controller. The data is obtained as 4-bit data by the INP8IO command and four upper significant bits (value = 0) are attached to extend the 4-bit data to 8-bit data.

Softkey Tree

STIMULUS Block

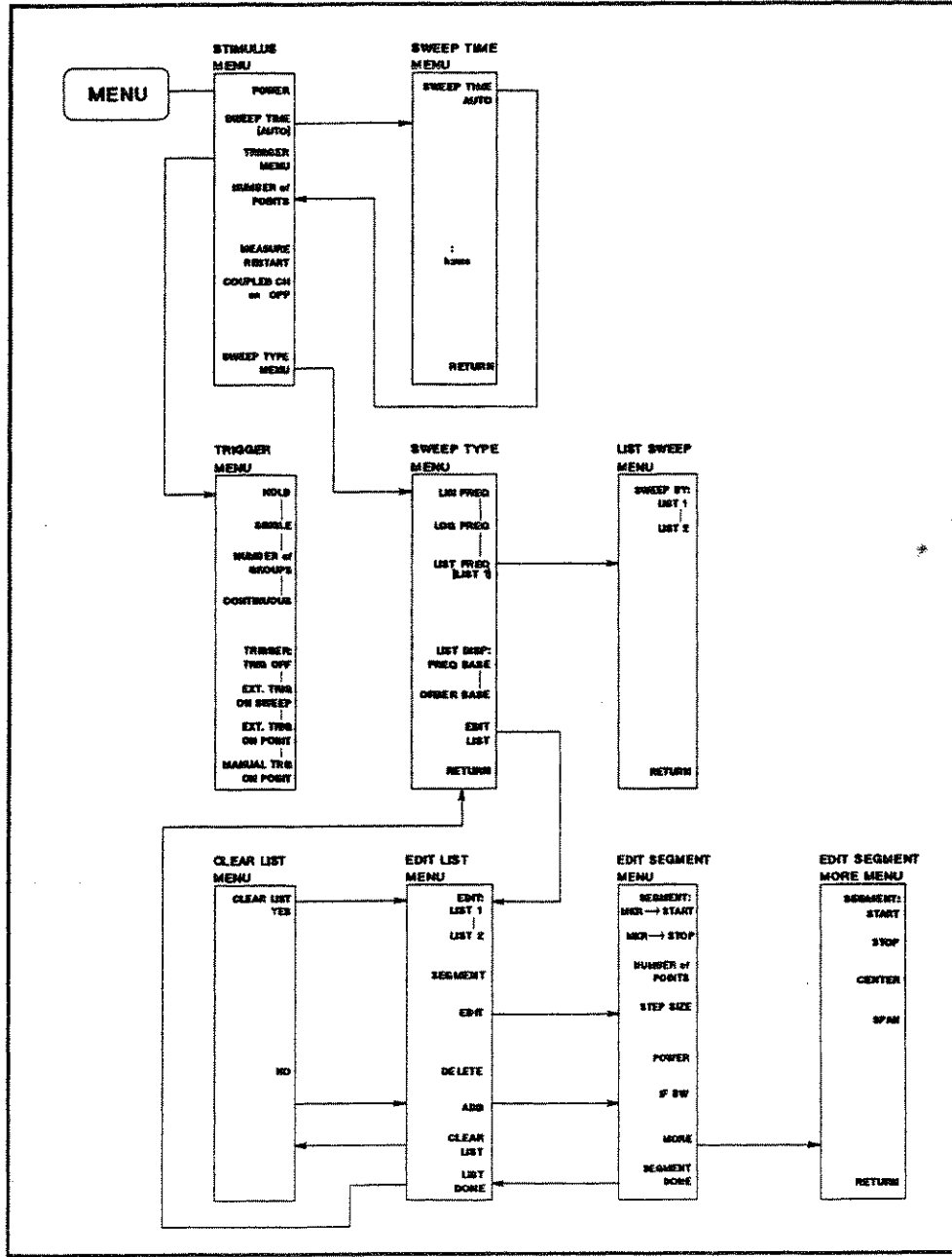

Figure E-1. **MENU** key

RESPONSE Block

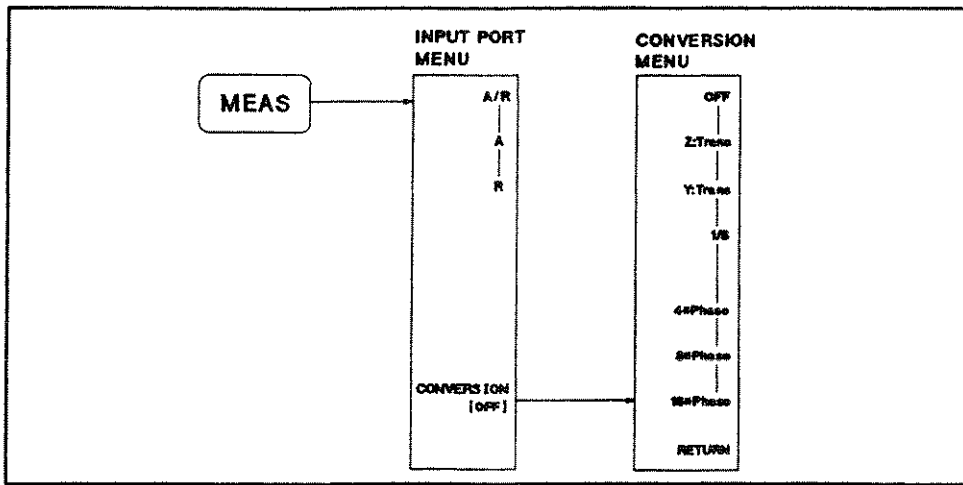

Figure E-2. **MEAS** Key

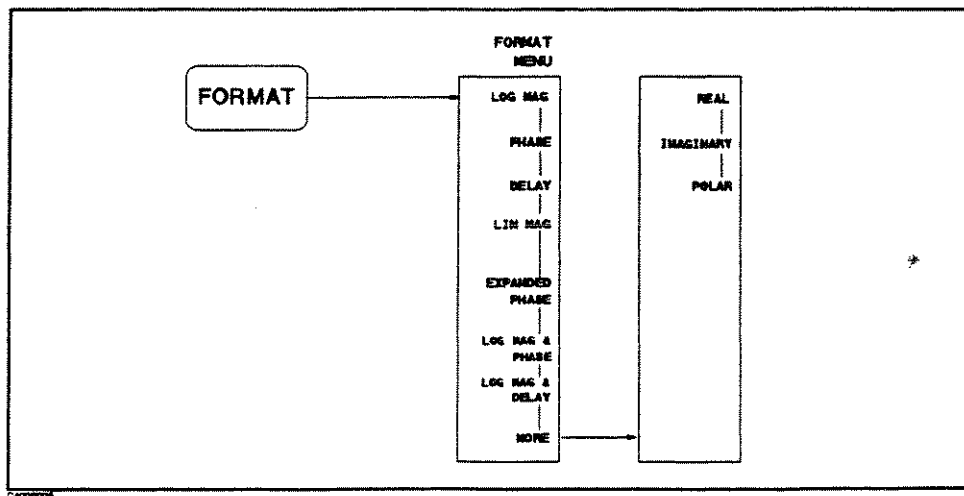

Figure E-3. **FORMAT** Key

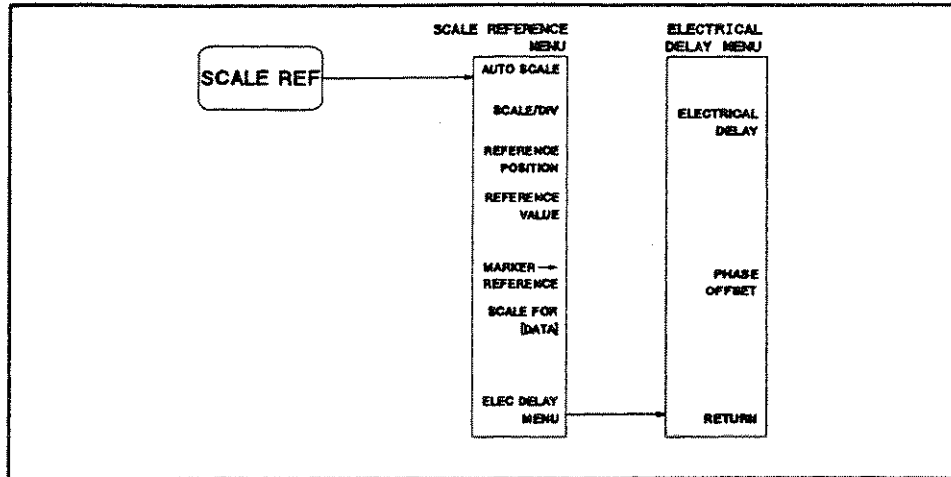

Figure E-4. **SCALE REF** Key

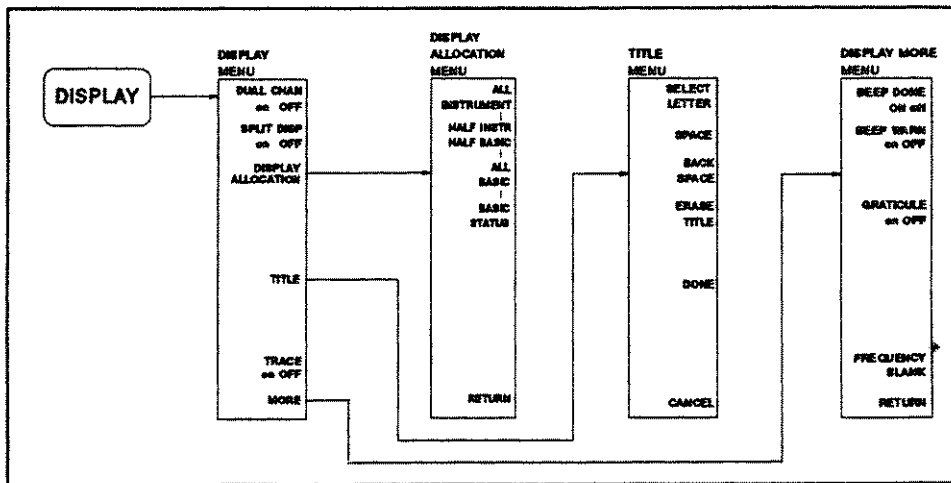

Figure E-5. **DISPLAY** Key

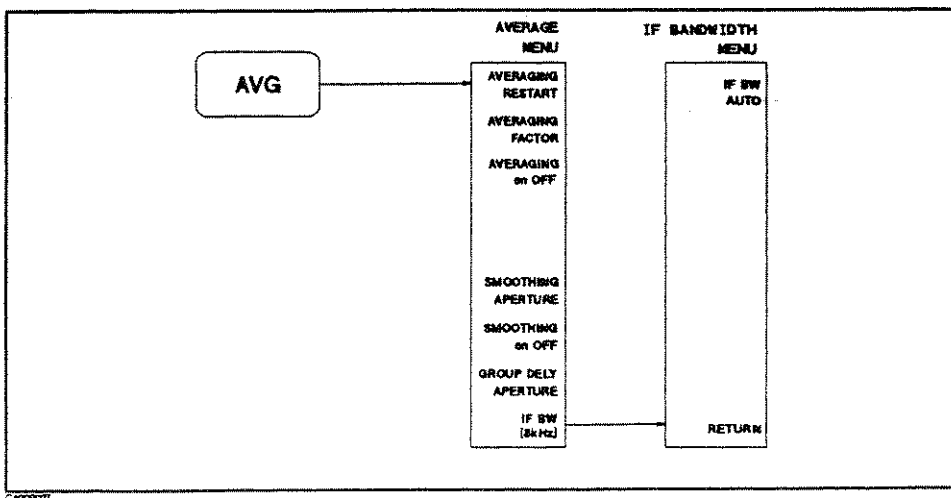

Figure E-6. **AVG** Key

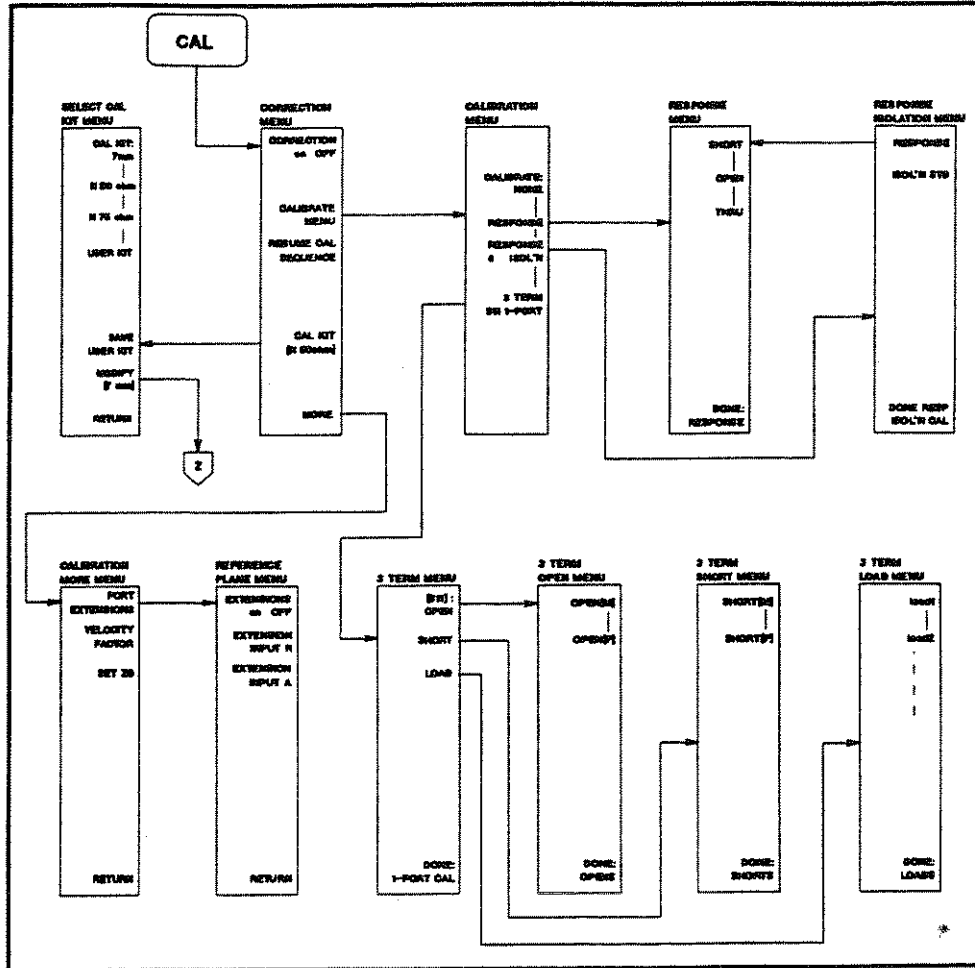

Figure E-7. CAL Key (1/2)

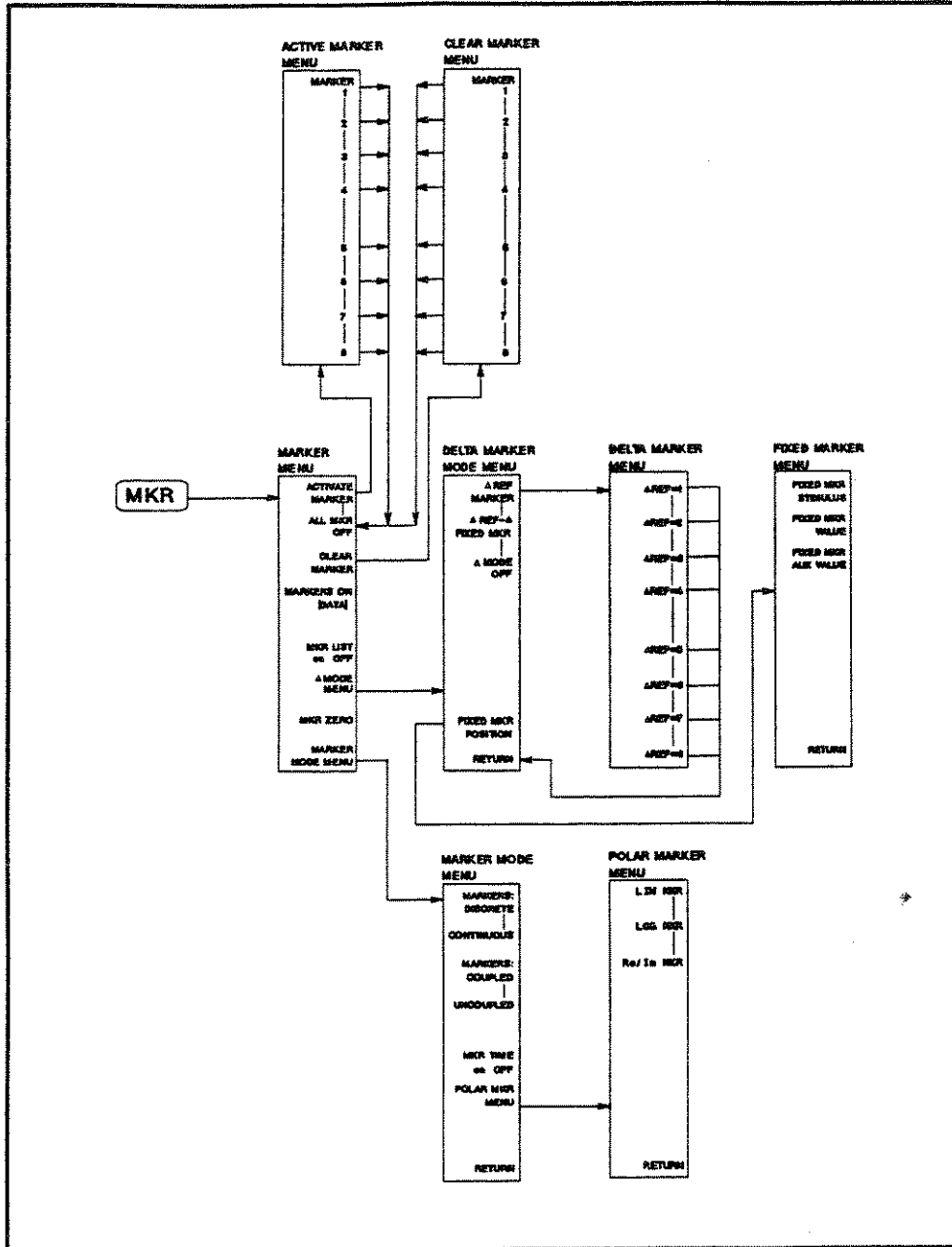
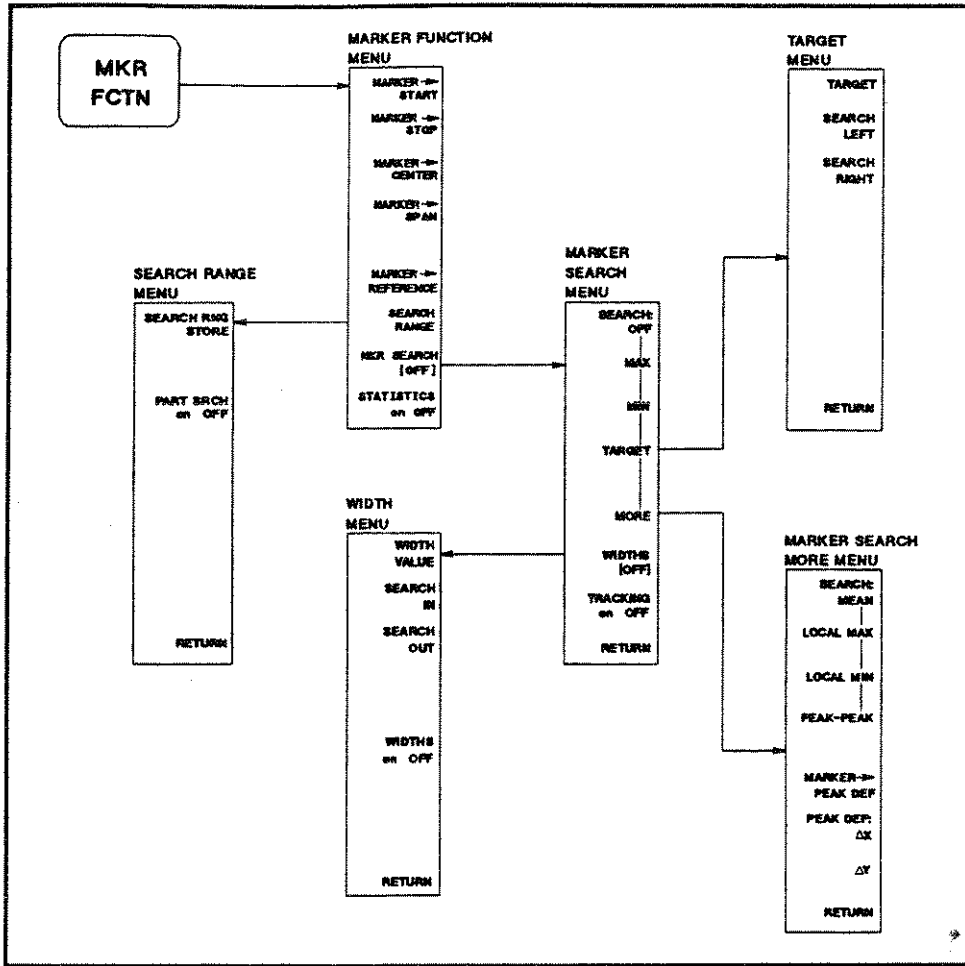
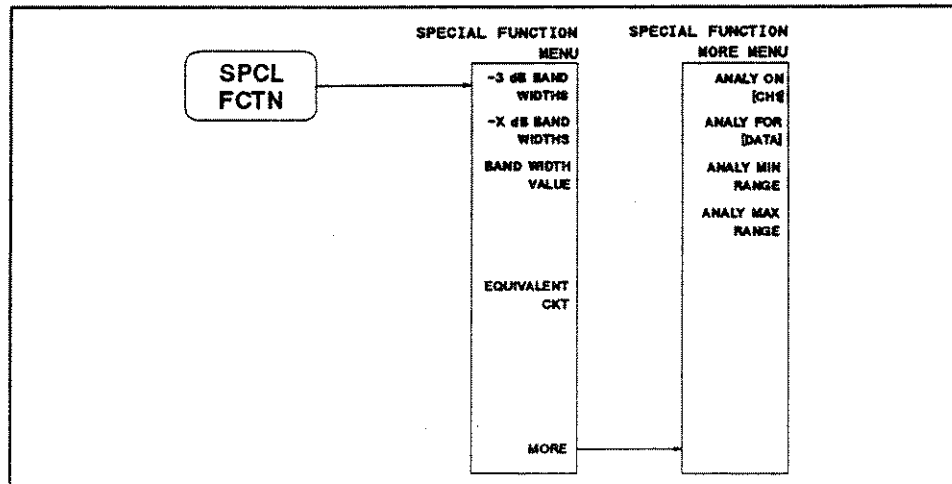

Figure E-9. **MKR** Key



C40900

Figure E-10. MKR FCTN Key



C409002

Figure E-11. SPCL FCTN Key

INSTRUMENT STATE FUNCTION Block

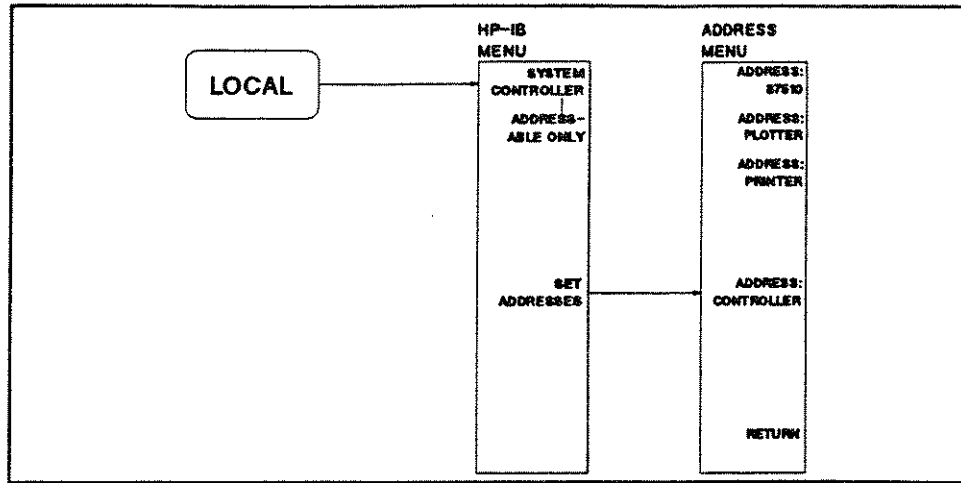

Figure E-12. LOCAL Key

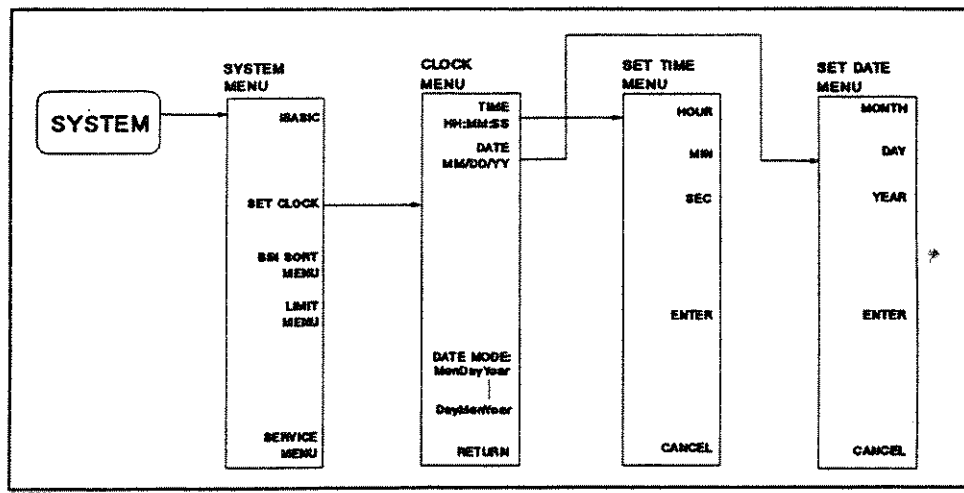

Figure E-13. SYSTEM Key (1/4)

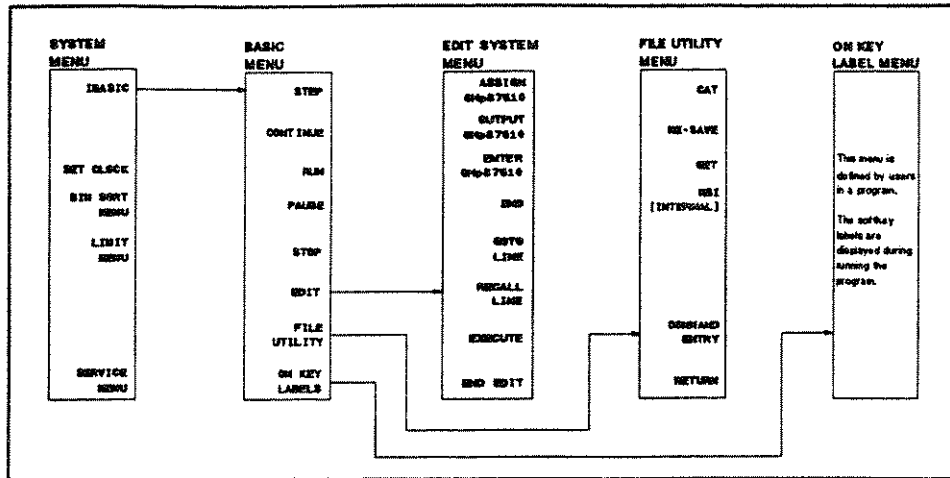

Figure E-14. (SYSTEM) Key (2/4)

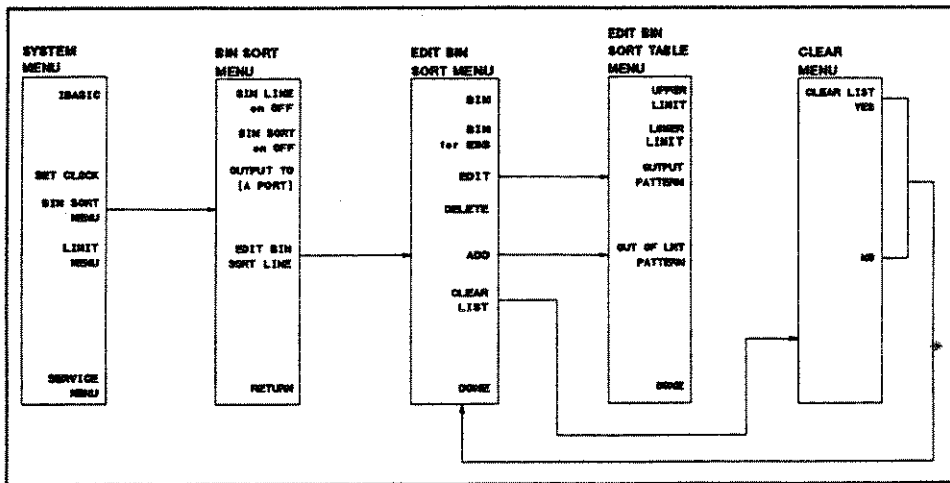

Figure E-15. (SYSTEM) Key (3/4)

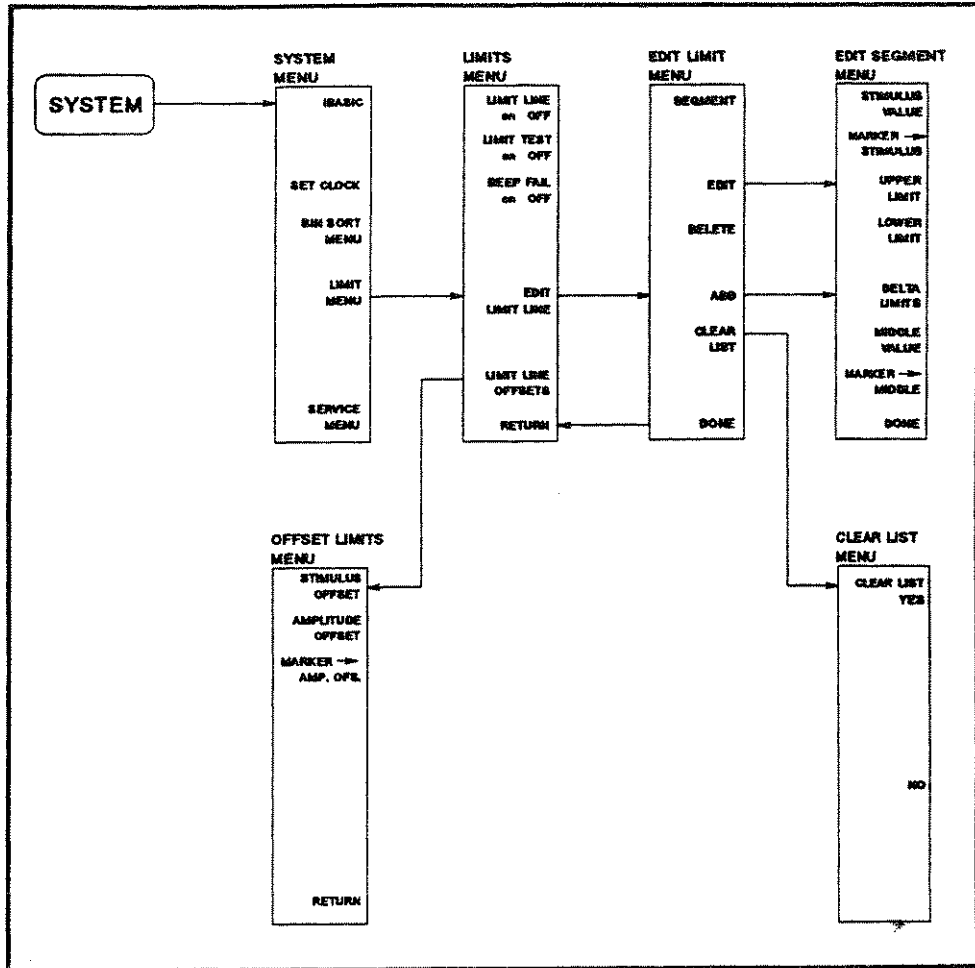

Figure E-16. **SYSTEM** Key (4/4)

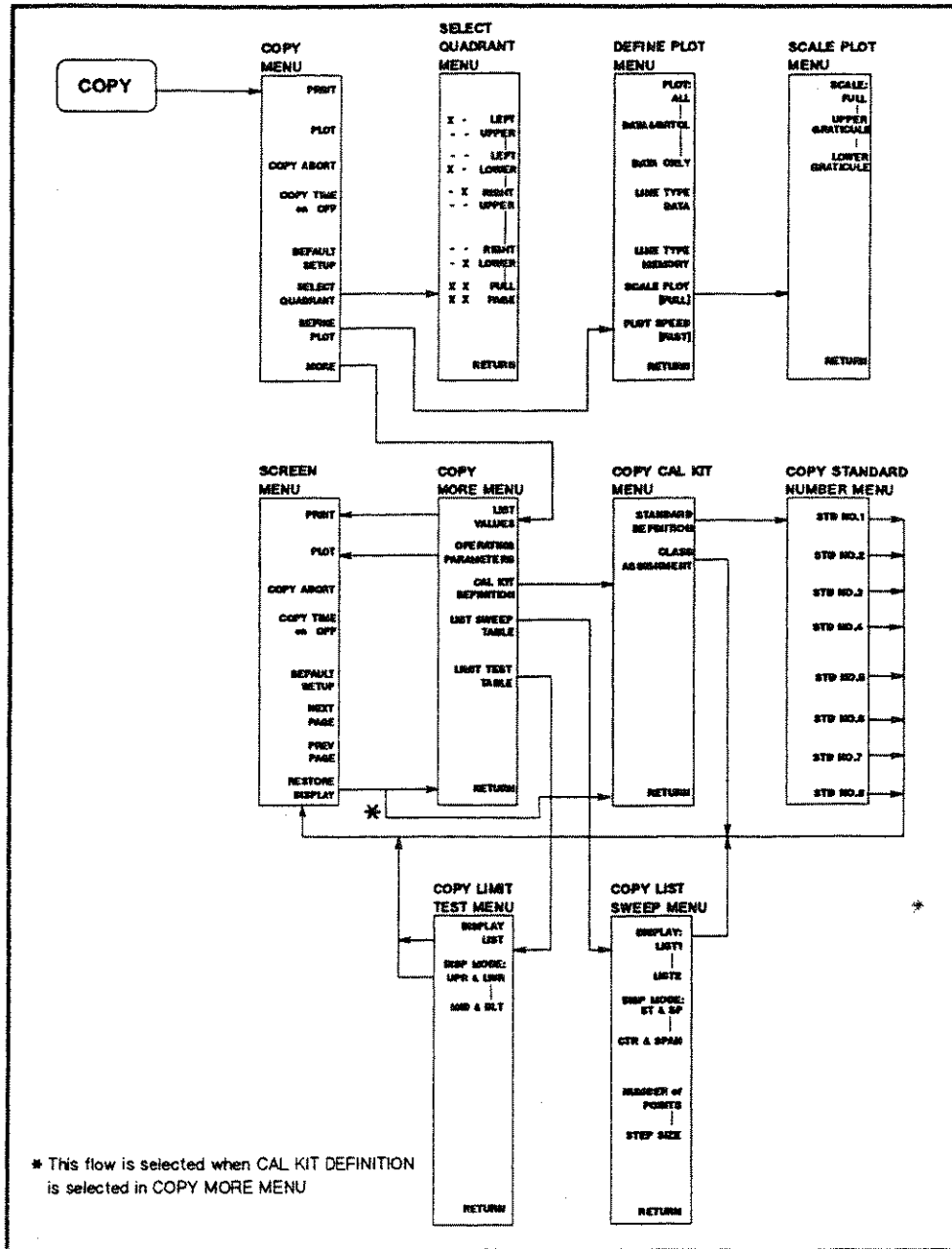
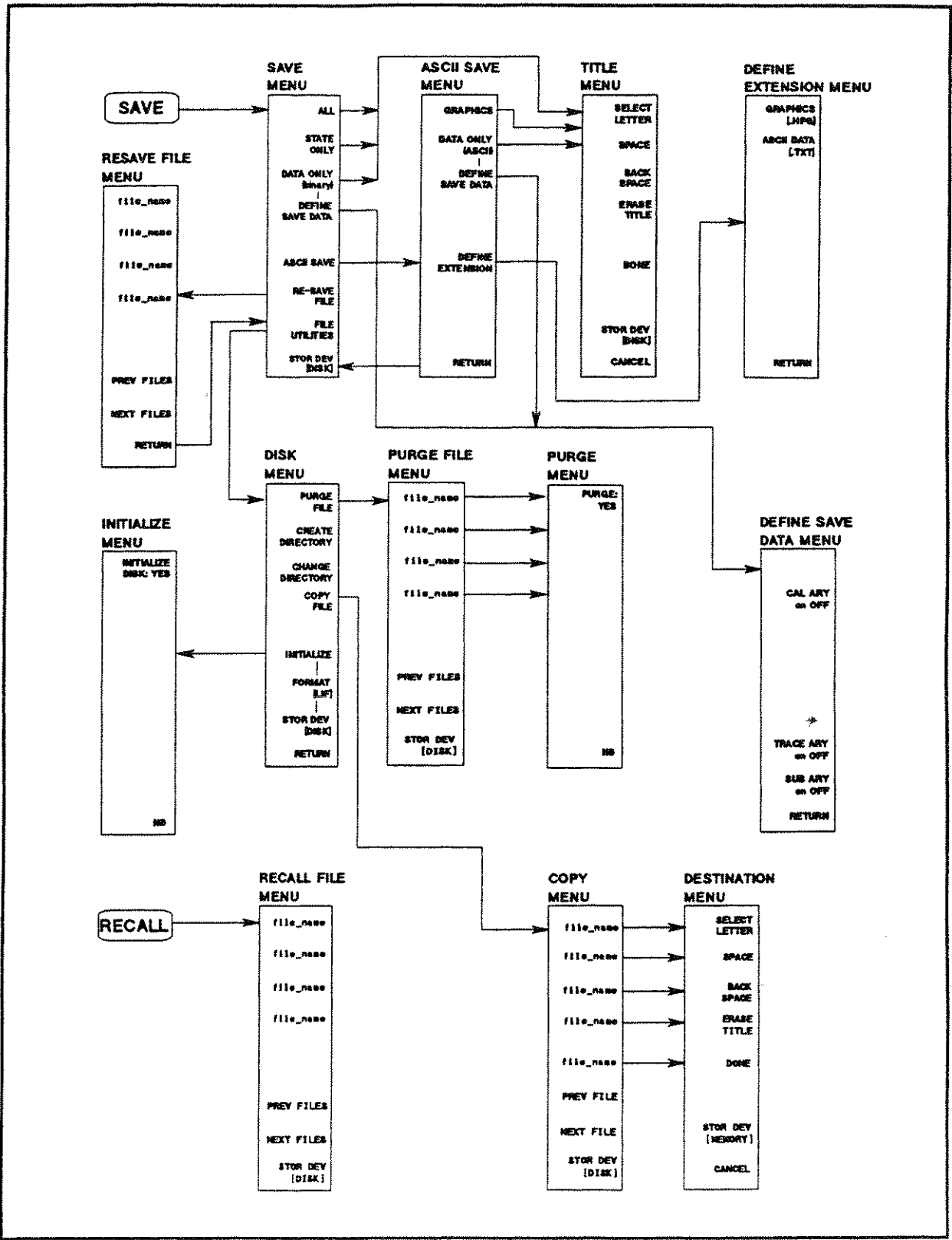

Figure E-17. COPY Key



C4014004

Figure E-18. **SAVE** and **RECALL** Key

Error Messages

This section lists the error messages that are displayed on the analyzer display or transmitted by the instrument over HP-IB. Each error message is accompanied by an explanation, and suggestions are provided to help in solving the problem. Where applicable, references are given to related sections of the Operation and Maintenance manuals.

When displayed, error messages are usually preceded with the word "CAUTION:". That part of the error message has been omitted here for the sake of brevity. Some messages are for information only, and do not indicate an error condition. Two listings are provided: the first is in alphabetical order, and the second in numerical order.

In addition to error messages, instrument status is indicated by status notations in the left margin of the display. Examples are "*", "msH", and "P↓". Sometimes these appear in conjunction with error messages. A complete listing of status and notations and their meanings is provided in "Front and Rear Panel" in the *Reference Manual*.

Error Messages in Alphabetical Order

160 +12V OUT OF SPEC

Severe error. Contact your nearest Hewlett-Packard office.

161 +15V(A) OUT OF SPEC

Severe error. Contact your nearest Hewlett-Packard office.

163 +15.3V OUT OF SPEC

Severe error. Contact your nearest Hewlett-Packard office.

158 +18V OUT OF SPEC

Severe error. Contact your nearest Hewlett-Packard office.

162 +22V OUT OF SPEC

Severe error. Contact your nearest Hewlett-Packard office.

166 +5V(A) OUT OF SPEC

Severe error. Contact your nearest Hewlett-Packard office.

164 +5V(D) OUT OF SPEC

Severe error. Contact your nearest Hewlett-Packard office.

157 -12.6V OUT OF SPEC

Severe error. Contact your nearest Hewlett-Packard office.

156 -15V OUT OF SPEC

Severe error. Contact your nearest Hewlett-Packard office.

168 -5.3V(A) OUT OF SPEC

Severe error. Contact your nearest Hewlett-Packard office.

193 1st IF OFFSET OSC TEST FAILED

Severe error. Contact your nearest Hewlett-Packard office.

195 1st LOCAL OSC TEST FAILED

Severe error. Contact your nearest Hewlett-Packard office.

150 A1 CPU EXT BUS TEST FAILED

Severe error. Contact your nearest Hewlett-Packard office.

142 A1 ROM TEST FAILED

Severe error. Contact your nearest Hewlett-Packard office.

A40 HEAT SINK TOO HOT

The temperature sensors on the A4 post-regulator assembly have detected an over-temperature condition. Turn the power OFF and let the instrument cool down for approximately 10 minutes. If this message is displayed again, contact your nearest Hewlett-Packard office.

174 Ach A/D LINEARITY POOR

Severe error. Contact your nearest Hewlett-Packard office.

167 Ach A/D REF VOLTAGE OUT OF SPEC

Severe error. Contact your nearest Hewlett-Packard office.

171 Ach RECEIVER FUNCTIONALLY POOR

Severe error. Contact your nearest Hewlett-Packard office.

6 ADDITIONAL STANDARD NEEDED

Error correction for the selected calibration class cannot be computed until all the necessary standards have been measured.

14 BACKUP DATA LOST

Data check-sum error on the battery backup memory has occurred. The battery is recharged for approximately 10 minutes after power was turned ON.

144 BACKUP RAM TEST FAILED

Severe error. Contact your nearest Hewlett-Packard office.

-160 Block data error

Block data is improper.

-168 Block data not allowed

Block data is not allowed.

9 CALIBRATION ABORTED

The calibration in progress was terminated due to the change of the active channel or the stimulus parameters.

7 CALIBRATION REQUIRED

No valid calibration coefficients were found when user attempted to turn calibration on. See "Measurement Calibration" in the *Reference Manual*.

61 CAN'T CHANGE-ANOTHER CONTROLLER ON BUS

The analyzer cannot assume the mode of system controller until the active controller is removed from the bus or relinquishes the bus.

107 CAN'T SAVE GRAPHICS WHEN COPY IN PROGRESS

If user attempts to save graphics when a print or plot is in progress, this error message is displayed.

-148 Character data not allowed

Character data not allowed for this operation.

-144 Character data too long

Character data is too long (maximum length is 12 characters).

137 CONTINUOUS SWITCHING NOT ALLOWED

The current measurement requires the S-parameter test set to switch automatically between forward and reverse measurements (driving test port 1 and, then test port 2). See "Stimulus Function Block" in the *Reference Manual*.

-253 CORRUPT MEDIA

A legal program command could not be executed because of corrupt media; for example, a bad disk or wrong format.

13 CURRENT PARAMETER NOT IN CAL SET

HP-IB only. Correction is not valid for the selected measurement parameter. See "Measurement Calibration" in the *Reference Manual*.

-222 Data out of range

Numerical parameter of HP-IB command is out of the range defined.

-104 Data type error

Improper data type used (for example, string data was expected, but numeric data was received).

98 DC OVERLOAD ON INPUT A

99 DC OVERLOAD ON INPUT R

The DC voltage at one of the three receiver inputs approach the DC voltage damage level. See "Instrument Specifications" in the *General Information* section for DC damage level information.

-255 DIRECTORY FULL

A legal program command could not be executed because the media directory was full.

143 DRAM TEST FAILED

Severe error. Contact your nearest Hewlett-Packard office.

145 EEPROM TEST FAILED

Severe error. Contact your nearest Hewlett-Packard office.

183 EEPROM WRITE FAILED

Severe error. Contact your nearest Hewlett-Packard office.

12 EXCEEDED 7 STANDARDS PER CLASS

A maximum of seven standards can be defined for any class. See "Measurement Calibration" in the *Reference Manual*.

5 EXTERNAL REFERENCE UNLOCKED

The frequency of the external reference signal input to the connector on the rear panel deviates from $10/N$ MHz, where N is an integer between 1 to 10, and phase lock can no longer be maintained. See "Front and Rear Panel" in the *Reference Manual* for details about the signal requirements.

197 FAILURE FOUND ON A2 BOARD

Severe error. Contact your nearest Hewlett-Packard office.

199 FAILURE FOUND ON FLOPPY DISK DRIVER

Contact your nearest Hewlett-Packard office.

159 FAN POWER OUT OF SPEC

Severe error. Contact your nearest Hewlett-Packard office.

154 FDC CHIP TEST FAILED

Severe error. Contact your nearest Hewlett-Packard office.

-257 FILE NAME ERROR

A legal program command could not be executed because the file name on the device media was in error; for example, an attempt was made to copy to a duplicate file name.

-256 FILE NAME NOT FOUND

A legal program command could not be executed because the file name on the device media was not found; for example, an attempt was made to read or copy a nonexistent file.

192 FN FREQ TEST FAILED

Severe error. Contact your nearest Hewlett-Packard office.

182 FN PRETUNE-DAC/MONITOR FAILURE

Severe error. Contact your nearest Hewlett-Packard office.

200 FN SPURIOUS TEST FAILED

Sever error. Contact your nearest Hewlett-Packard office.

148 FPC TEST FAILED

Severe error. Contact your nearest Hewlett-Packard office.

-105 GET not allowed

GET is not allowed inside a program message.

151 GSP I/F TEST FAILED

Severe error. Contact your nearest Hewlett-Packard office.

155 HPIB CHIP TEST FAILED

Severe error. Contact your nearest Hewlett-Packard office.

147 INTR TIMER TEST FAILED

Severe error. Contact your nearest Hewlett-Packard office.

-161 Invalid block data

Invalid block data was received (for example, END received before length satisfied).

-141 Invalid character data

Bad character data or unrecognized character data was received.

-121 Invalid character in number

Invalid character in numeric data.

-101 Invalid character

Invalid character was received.

214 INVALID DATE

Invalid date was set.

105 INVALID FILE NAME

HP-IB only. The file name for the RECALL, PURGE, or RE-SAVE function must have an "_A", "_D", or "_S" extension. See "Saving and Recalling Instrument States and Data" in the *Reference Manual* for more information.

-103 Invalid separator

The message unit separator (for example, ";", ",", ") is improper.

-151 Invalid string data

Invalid string data was received (for example, END received before close quote).

-131 Invalid suffix

Units are unrecognized, or the units are not appropriate.

153 KEY CHIP TEST FAILED

Severe error. Contact your nearest Hewlett-Packard office.

108 LIF-DOS COPY NOT ALLOWED

If the user tries to copy a file between the RAM disk and the flexible disk when the format of the RAM disk is different from the format of the flexible disk, this message is displayed.

67 LIST TABLE EMPTY OR INSUFFICIENT TABLE

The frequency list is empty. To implement the list frequency mode, add segments to the list table. See "Stimulus Function Block" in the *Reference Manual*.

61 LOCAL MAX NOT FOUND

The maximum peak whose sharpness is defined by the peak define function cannot be found.

62 LOCAL MIN NOT FOUND

The minimum peak whose sharpness is defined by the peak define function cannot be found.

-250 MASS STORAGE ERROR

A mass storage error occurred. This error message is used when the device cannot detect the more specific errors described for errors -251 through -259.

-254 MEDIA FULL

A legal program command could not be executed because the media was full.

-258 **MEDIA PROTECTED**

A legal program command could not be executed because the media was protected; for example, the disk was write-protected.

-251 **MISSING MASS STORAGE**

A legal program command could not be executed because of missing mass storage; for example, attempt to access an external disk drive by using Instrument BASIC.

-252 **MISSING MEDIA**

A legal program command could not be executed because of a missing media; for example, no disk.

-109 **Missing parameter**

A command with an improper number of parameters received.

179 **MIXER LINEARITY POOR**

Severe error. Contact your nearest Hewlett-Packard office.

8 **NO CALIBRATION CURRENTLY IN PROGRESS**

The **RESUME CAL SEQUENCE** softkey is not valid unless a calibration was already in progress. Start a new calibration. See "Measurement Calibration" in the *Reference Manual*.

77 **NO DATA TRACE**

The **MARKER ON [DATA]** is selected while the data trace is not displayed.

106 **NO LEGAL FILES ON DISK**

There are no files on the disk with extensions, "_A", "_D", or "_S". See "Saving and Recalling Instrument States and Data" in the *Reference Manual* for more information.

83 **NO MARKER DELTA - PEAK DEF NOT SET**

The **MARKER → PEAK DEF** softkey requires that delta marker mode be turned ON, with at least two markers displayed. See "Using Markers" in the *Reference Manual*.

80 **NO MARKER DELTA - RANGE NOT SET**

The **SEARCH RNG STORE** softkey requires that delta marker mode be turned ON, with at least two markers displayed. See "Using Markers" in the *Reference Manual*.

79 **NO MARKER DELTA - SPAN NOT SET**

The **MARKER → SPAN** softkey requires that delta marker mode be turned ON, with at least two markers displayed. See "Using Markers" in the *Reference Manual*.

78 **NO SUB TRACE**

The **MARKER FOR [SUB]** is selected while the sub trace is not displayed.

113 NO SUB TRACE DISPLAYED

The **SCALE FOR [SUB]** is selected while the memory trace is not displayed.

118 NO VALID Ach ABS MAG CORRECTION CONSTANTS

Severe error. Contact your nearest Hewlett-Packard office.

126 NO VALID FN PRETUNE CORRECTION CONSTANTS

Severe error. Contact your nearest Hewlett-Packard office.

30 NO VALID MEMORY

If a memory array is to be displayed or otherwise used, a data must first be stored to memory by HP-IB.

124 NO VALID PWR LIN CORRECTION CONSTANTS

Severe error. Contact your nearest Hewlett-Packard office.

120 NO VALID RATIO A/R CORRECTION CONSTANTS

Severe error. Contact your nearest Hewlett-Packard office.

117 NO VALID Rch ABS MAG CORRECTION CONSTANTS

Severe error. Contact your nearest Hewlett-Packard office.

31 NOT AVAILABLE FOR THIS FORMAT

The **D&M SCALE [COUPLED]** softkey is not valid when the format is either LOG MAG & PHASE, or LOG MAG & DELAY.

41 NOT ENOUGH DATA

HP-IB only. The amount of data sent to the analyzer is less than that expected.

-128 Numeric data not allowed

Numerical data not allowed for this operation.

-123 Numeric overflow

Numerical data value was too large (exponent magnitude >32,000).

-108 Parameter not allowed

Too many parameters for the command received.

25 PLOTTER NOT READY-PINCH WHEELS UP

If user attempts to plot when the plotter's pinch wheels are up, this message is displayed.

23 PLOTTER: not on, not connected, wrong address

The plotter does not respond to control. Verify power to the plotter, and check the HP-IB connection between the analyzer and the plotter. Ensure that the plotter address recognized by the analyzer matches the HP-IB address set on the plotter itself. See "Instrument State Function Block" in the *Reference Manual* for instruction on setting peripheral addresses.

186 POWER LINEARITY TEST FAILED

Severe error. Contact your nearest Hewlett-Packard office.

POWER SHUT DOWN (ANALOG SYSTEM)

Severe error. Contact your nearest Hewlett-Packard office.

4 POWER SHUT DOWN (FDD, FRONT PANEL)

Severe error. Contact your nearest Hewlett-Packard office.

22 PRINTER: not on, not connected, wrong address

The printer does not respond to control. Verify power to the plotter, and check the HP-IB connection between the analyzer and the printer. Ensure that the printer address recognized by the analyzer matches the HP-IB address set on the printer itself. See "Instrument State Function Block" in the *Reference Manual* for instruction on setting peripheral addresses.

-112 Program mnemonic too long

Program mnemonic is too long (maximum length is 12 characters).

-430 Query DEADLOCKED

Input buffer and output buffer are full; cannot continue.

-400 Query error

Query is improper.

-410 Query INTERRUPTED

Query is followed by DAB or GET before the response was completed.

-440 Query UNTERMINATED after indefinite response

The query which requests arbitrary data response (*IDN? and *OPT? queries) was sent before usual queries in a program message. (for example, FREQ?; *IDN? was expected, but *IDN?; FREQ? is received.)

-420 Query UNTERMINATED

Addressed to talk, incomplete program message received.

146 RATE TIMER TEST FAILED

Severe error. Contact your nearest Hewlett-Packard office.

173 Rch A/D LINEARITY POOR

Severe error. Contact your nearest Hewlett-Packard office.

165 Rch A/D REF VOLTAGE OUT OF SPEC

Severe error. Contact your nearest Hewlett-Packard office.

170 Rch RECEIVER FUNCTIONALLY POOR

Severe error. Contact your nearest Hewlett-Packard office.

149 REALTIME CLOCK TEST FAILED

Severe error. Contact your nearest Hewlett-Packard office.

REAR PANEL FAN STOPPED

The analyzer detected that the rear panel fan stopped and automatically shut down the power.

104 RECALL ERROR: INSTR STATE PRESET

A serious error, for example corrupted data, is detected on recalling a file, and this forced the analyzer to be PRESET.

194 RF OSC TEST FAILED

Severe error. Contact your nearest Hewlett-Packard office.

189 RF POWER LEVEL (LF) TEST FAILED

Severe error. Contact your nearest Hewlett-Packard office.

103 SAVE ERROR

A serious error, for example physically damaged disk surface, is detected on saving a file.

-150 String data error

String data is improper.

-158 String data not allowed

String data is not allowed.

-138 Suffix not allowed

A suffix is not allowed for this operation.

-102 Syntax error

Unrecognized command or data type was received.

-124 Too many digits

Numerical data length was too long (more than 255 digits received).

224 TOO MANY ENTRY

The maximum number of BINs for BIN sorting is 16.

-350 Too many errors

Too many errors occurred in HP-IB commands.

50 TOO MANY SEGMENTS

The maximum number of segments for the limit line table is 18. See "Instrument State Function Block" in the *Reference Manual*.

68 TOO MANY SEGMENTS OR POINTS

Frequency list mode is limited to 31 segments or 801 points. See "Stimulus Function Block" in the *Reference Manual* for more information.

-223 Too much data

Either there is too much binary data to send to the analyzer when the data transfer format is FORM 2, FORM 3 or FORM 5, or the amount of data is greater than the number of points.

41 TOO MUCH DATA

The number of data to be sent to the analyzer is greater than that expected.

-113 Undefined header

Undefined header or an unrecognized command was received (operation not allowed).

180 VCO MISADJUSTED, RETRY THIS TEST

Severe error. Contact your nearest Hewlett-Packard office.

152 VRAM TEST FAILED

Severe error. Contact your nearest Hewlett-Packard office.

235 WRONG I/O PORT DIRECTION

The direction of I/O port C or D is opposite.

Error Messages in Numerical Order

POWER SHUT DOWN (ANALOG SYSTEM)

Severe error. Contact your nearest Hewlett-Packard office.

A40 HEAT SINK TOO HOT

The temperature sensors on the A4 post-regulator assembly have detected an over-temperature condition. Turn the power off and let the instrument cool down for approximately 10 minutes. If this message is displayed again, contact your nearest Hewlett-Packard office.

REAR PANEL FAN STOPPED

The analyzer detected that the rear panel fan stopped and automatically shut down the power.

4 POWER SHUT DOWN (FDD, FRONT PANEL)

Severe error. Contact your nearest Hewlett-Packard office.

5 EXTERNAL REFERENCE UNLOCKED

The frequency of the external reference signal input to the connector on the rear panel deviates from $10/N$ MHz, where N is an integer between 1 to 10, and phase lock can no longer be maintained. See "Front and Rear Panel" in the *Reference Manual* for details about the signal requirements.

6 ADDITIONAL STANDARDS NEEDED

Error correction for the selected calibration class cannot be computed until all the necessary standards have been measured.

7 CALIBRATION REQUIRED

No valid calibration coefficients were found when user attempted to turn calibration on. See "Measurement Calibration" in the *Reference Manual*.

8 NO CALIBRATION CURRENTLY IN PROGRESS

The **RESUME CAL SEQUENCE** softkey is not valid unless a calibration was already in progress. Start a new calibration. See "Measurement Calibration" in the *Reference Manual*.

9 CALIBRATION ABORTED

The calibration in progress was terminated due to change of the active channel or stimulus parameters.

12 EXCEEDED 7 STANDARDS PER CLASS

A maximum of seven standards can be defined for any class. See "Measurement Calibration" in the *Reference Manual*.

13 CURRENT PARAMETER NOT IN CAL SET

HP-IB only. Correction is not valid for the selected measurement parameter. See "Measurement Calibration" in the *Reference Manual*.

14 BACKUP DATA LOST

Data check-sum error on the battery backup memory has occurred. The battery is recharged for approximately 10 minutes after power was turned on.

22 PRINTER: not on, not connect, wrong address

The printer does not respond to control. Verify power to the plotter, and check the HP-IB connection between the analyzer and the printer. Ensure that the printer address recognized by the analyzer matches the HP-IB address set on the printer itself. See "Instrument State Function Block" in the *Reference Manual* for instruction on setting peripheral addresses.

23 PLOTTER: not on, not connect, wrong address

The plotter does not respond to control. Verify power to the plotter, and check the HP-IB connection between the analyzer and the plotter. Ensure that the plotter address recognized by the analyzer matches the HP-IB address set on the plotter itself. See "Instrument State Function Block" in the *Reference Manual* for instruction on setting peripheral addresses.

25 PLOTTER NOT READY-PINCH WHEELS UP

If user attempts to plot when the plotter's pinch wheels are up, this message is displayed.

30 NO VALID MEMORY

If a memory array is to be displayed or otherwise used, a data must first be stored to memory by HP-IB.

40 TOO MUCH DATA

The amount of data to be sent to the analyzer is greater than that expected.

41 NOT ENOUGH DATA

HP-IB only. The amount of data sent to the analyzer is less than that expected.

50 TOO MANY SEGMENTS

The maximum number of segments for the limit line table is 18. See "Instrument State Function Block" in the *Reference Manual*.

61 CAN'T CHANGE- ANOTHER CONTROLLER ON BUS

The analyzer cannot assume the mode of system controller until the active controller is removed from the bus or relinquishes the bus.

67 LIST TABLE EMPTY OR INSUFFICIENT TABLE

The frequency list is empty. To implement the list frequency mode, add segments to the list table. See "Stimulus Function Block" in the *Reference Manual*.

68 TOO MANY SEGMENTS OR POINTS

Frequency list mode is limited to 31 segments or 801 points. See "Stimulus Function Block" in the *Reference Manual* for more information.

77 NO DATA TRACE

The **MARKER ON [DATA]** is selected while the data trace is not displayed.

78 NO MEMORY TRACE

The **MARKER ON [MEMORY]** is selected while the memory trace is not displayed.

79 NO MARKER DELTA - SPAN NOT SET

The **MARKER → SPAN** softkey requires that delta marker mode be turned ON, with at least two markers displayed. See "Using Markers" in the *Reference Manual*.

80 NO MARKER DELTA - RANGE NOT SET

The **SEARCH RNG STORE** softkey requires that delta marker mode be turned ON, with at least two markers displayed. See "Using Markers" in the *Reference Manual*.

81 LOCAL MAX NOT FOUND

The maximum peak whose sharpness is defined by the peak define function cannot be found.

82 LOCAL MIN NOT FOUND

The minimum peak whose sharpness is defined by the peak define function cannot be found.

83 NO MARKER DELTA - PEAK DEF NOT SET

The **MARKER → PEAK DEF** softkey requires that delta marker mode be turned ON, with at least two markers displayed. See "Using Markers" in the *Reference Manual*.

95 OVERLOAD ON INPUT A, POWER REDUCED

96 OVERLOAD ON INPUT R, POWER REDUCED

When the power level at one of the three receiver inputs exceeds a certain level greater than the maximum input level, the RF output power level is automatically reduced to minimum and the annotation "P↓" appears in the left margin of the display. See "Stimulus Function Block" in the *Reference Manual*.

103 SAVE ERROR

A serious error, for example physically damaged disk surface, is detected on saving a file.

104 RECALL ERROR: INSTR STATE PRESET

A serious error, for example corrupted data, is detected on recalling a file, and this forced the analyzer to be PRESET.

105 INVALID FILE NAME

HP-IB only. The file name for the RECALL, PURGE, or RE-SAVE function must have an "_A", "_D", or "_S" extension. See "Saving and Recalling Instrument States and Data" in the *Reference Manual* for more information.

106 NO LEGAL FILES ON DISK

There are no files on the disk with extensions, "_A", "_D", or "_S". See "Saving and Recalling Instrument States and Data" in the *Reference Manual* for more information.

107 CAN'T SAVE GRAPHICS WHEN COPY IN PROGRESS

If user attempts to save graphics when a print or plot is in progress, this error message is displayed.

108 LIF-DOS COPY NOT ALLOWED

If the user tries to copy a file between the RAM disk and the flexible disk when the format of the RAM disk is different from the format of the flexible disk, this message is displayed.

112 NO DATA TRACE DISPLAYED

The **SCALE FOR [DATA]** is selected while the data trace is not displayed.

113 NO MEMORY TRACE DISPLAYED

The **SCALE FOR [MEMORY]** is selected while the memory trace is not displayed.

117 NO VALID Rch ABS MAG CORRECTION CONSTANTS

Severe error. Contact your nearest Hewlett-Packard office.

118 NO VALID Ach ABS MAG CORRECTION CONSTANTS

Severe error. Contact your nearest Hewlett-Packard office.

120 NO VALID RATIO A/R CORRECTION CONSTANTS

Severe error. Contact your nearest Hewlett-Packard office.

124 NO VALID HF PWR LIN CORRECTION CONSTANTS

Severe error. Contact your nearest Hewlett-Packard office.

126 NO VALID FN PRETUNE CORRECTION CONSTANTS

Severe error. Contact your nearest Hewlett-Packard office.

142 A1 ROM TEST FAILED

Severe error. Contact your nearest Hewlett-Packard office.

143 DRAM TEST FAILED

Severe error. Contact your nearest Hewlett-Packard office.

144 BACKUP RAM TEST FAILED

Severe error. Contact your nearest Hewlett-Packard office.

145 EEPROM TEST FAILED

Severe error. Contact your nearest Hewlett-Packard office.

146 RATE TIMER TEST FAILED

Severe error. Contact your nearest Hewlett-Packard office.

147 INTR TIMER TEST FAILED

Severe error. Contact your nearest Hewlett-Packard office.

148 FPC TEST FAILED

Severe error. Contact your nearest Hewlett-Packard office.

149 REALTIME CLOCK TEST FAILED

Severe error. Contact your nearest Hewlett-Packard office.

150 A1 CPU EXT BUS TEST FAILED

Severe error. Contact your nearest Hewlett-Packard office.

151 GSP I/F TEST FAILED

Severe error. Contact your nearest Hewlett-Packard office.

152 VRAM TEST FAILED

Severe error. Contact your nearest Hewlett-Packard office.

153 KEY CHIP TEST FAILED

Severe error. Contact your nearest Hewlett-Packard office.

154 FDC CHIP TEST FAILED

Severe error. Contact your nearest Hewlett-Packard office.

155 HPIB CHIP TEST FAILED

Severe error. Contact your nearest Hewlett-Packard office.

156 -15V OUT OF SPEC

Severe error. Contact your nearest Hewlett-Packard office.

157 -12.6V OUT OF SPEC

Severe error. Contact your nearest Hewlett-Packard office.

158 +18V OUT OF SPEC

Severe error. Contact your nearest Hewlett-Packard office.

159 FAN POWER OUT OF SPEC

Severe error. Contact your nearest Hewlett-Packard office.

160 +12V OUT OF SPEC

Severe error. Contact your nearest Hewlett-Packard office.

161 +15V(A) OUT OF SPEC

Severe error. Contact your nearest Hewlett-Packard office.

162 +22V OUT OF SPEC

Severe error. Contact your nearest Hewlett-Packard office.

163 +65V OUT OF SPEC

Severe error. Contact your nearest Hewlett-Packard office.

164 +5V(D) OUT OF SPEC

Severe error. Contact your nearest Hewlett-Packard office.

165 Rch A/D REF VOLTAGE OUT OF SPEC

Severe error. Contact your nearest Hewlett-Packard office.

166 +5V(A) OUT OF SPEC

Severe error. Contact your nearest Hewlett-Packard office.

167 Ach A/D REF VOLTAGE OUT OF SPEC

Severe error. Contact your nearest Hewlett-Packard office.

168 -5.2V(A) OUT OF SPEC

Severe error. Contact your nearest Hewlett-Packard office.

170 Rch RECEIVER FUNCTIONALLY POOR

Severe error. Contact your nearest Hewlett-Packard office.

171 Ach RECEIVER FUNCTIONALLY POOR

Severe error. Contact your nearest Hewlett-Packard office.

173 Rch A/D LINEARITY POOR

Severe error. Contact your nearest Hewlett-Packard office.

174 Ach A/D LINEARITY POOR

Severe error. Contact your nearest Hewlett-Packard office.

177 IF GAIN OUT OF SPEC

Severe error. Contact your nearest Hewlett-Packard office.

179 MIXER LINEARITY POOR

Severe error. Contact your nearest Hewlett-Packard office.

180 VCO MISADJUSTED, RETRY THIS TEST

Severe error. Contact your nearest Hewlett-Packard office.

182 FN PRETUNE-DAC/MONITOR FAILURE

Severe error. Contact your nearest Hewlett-Packard office.

183 EEPROM WRITE FAILED

Severe error. Contact your nearest Hewlett-Packard office.

186 POWER LINEARITY TEST FAILED

Severe error. Contact your nearest Hewlett-Packard office.

189 RF POWER LEVEL ALC(LF) TEST FAILED

Severe error. Contact your nearest Hewlett-Packard office.

192 FN FREQ TEST FAILED

Severe error. Contact your nearest Hewlett-Packard office.

193 1st IF OFFSET OSC TEST FAILED

Severe error. Contact your nearest Hewlett-Packard office.

194 RF OSC TEST FAILED

Severe error. Contact your nearest Hewlett-Packard office.

195 1st LOCAL OSC TEST FAILED

Severe error. Contact your nearest Hewlett-Packard office.

197 FAILURE FOUND ON A2 BOARD

Severe error. Contact your nearest Hewlett-Packard office.

199 FAILURE FOUND ON FLOPPY DISK DRIVER

Severe error. Contact your nearest Hewlett-Packard office.

200 FN SPURIOUS TEST FAILED

Severe error. Contact your nearest Hewlett-Packard office.

201 +5V (I/O OUT) OUT OF SPEC

Severe error. Contact your nearest Hewlett-Packard office.

202 +5V (I/O BD) OUT OF SPEC

Severe error. Contact your nearest Hewlett-Packard office.

214 INVALID DATE

Invalid date was set.

224 TOO MANY ENTRY

The maximum number of BINs for BIN sorting is 16.

235 WRONG I/O PORT DIRECTION

The direction of I/O port C or D is opposite.

-440 Query UNTERMINATED after indefinite response

The query which requests arbitrary data response (*IDN? and *OPT? queries) was sent before usual queries in a program message. (for example, FREQ?;*IDN? was expected, but *IDN?;FREQ? is received.)

-430 Query DEADLOCKED

Input buffer and output buffer are full; cannot continue.

-420 Query UNTERMINATED

Addressed to talk, incomplete program message received.

-410 Query INTERRUPTED

Query is followed by DAB or GET before the response was completed.

-400 Query error

Query is improper.

-350 Too many errors

Too many errors occurred in HP-IB commands.

-258 MEDIA PROTECTED

A legal program command could not be executed because the media was protected; for example, the disk was write-protected.

-257 FILE NAME ERROR

A legal program command could not be executed because the file name on the device media was in error; for example, an attempt was made to copy to a duplicate file name.

-256 FILE NAME NOT FOUND

A legal program command could not be executed because the file name on the device media was not found; for example, an attempt was made to read or copy a nonexistent file.

-255 DIRECTORY FULL

A legal program command could not be executed because the media directory was full.

-254 MEDIA FULL

A legal program command could not be executed because the media was full.

-253 CORRUPT MEDIA

A legal program command could not be executed because of corrupt media; for example, a bad disk or wrong format.

-252 MISSING MEDIA

A legal program command could not be executed because of a missing media; for example, no disk.

-251 MISSING MASS STORAGE

A legal program command could not be executed because of missing mass storage; for example, attempt to access an external disk drive by using Instrument BASIC.

-250 MASS STORAGE ERROR

A mass storage error occurred. This error message is used when the device cannot detect the more specific errors described for errors -251 through -259.

-223 Too much data

Either there is too much binary data to send to the analyzer when the data transfer format is FORM 2, FORM 3 or FORM 5, or the amount of data is greater than the number of points.

-222 Data out of range

Numerical parameter of HP-IB command is out of the range defined.

-168 Block data not allowed

Block data is not allowed.

-161 Invalid block data

Invalid block data was received (for example, END received before length satisfied).

-160 Block data error

Block data is improper.

-158 String data not allowed

String data is not allowed.

-151 Invalid string data

Invalid string data was received (for example, END received before close quote).

-150 String data error

String data is improper.

-148 Character data not allowed

Character data not allowed for this operation.

-144 Character data too long

Character data is too long (maximum length is 12 characters).

-141 Invalid character data

Bad character data or unrecognized character data was received.

-138 Suffix not allowed

A suffix is not allowed for this operation.

-131 Invalid suffix

Units are unrecognized, or the units are not appropriate.

-128 Numeric data not allowed

Numerical data not allowed for this operation.

-124 Too many digits

Numerical data length was too long (more than 255 digits received).

-123 Numeric overflow

Numerical data value was too large (exponent magnitude > 32,000).

-121 Invalid character in number

Invalid character in numeric data.

-113 Undefined header

Undefined header or an unrecognized command was received (operation not allowed).

-112 Program mnemonic too long

Program mnemonic is too long (maximum length is 12 characters).

-109 Missing parameter

A command with an improper number of parameters was received.

-108 Parameter not allowed

Too many parameters for the command received.

-105 GET not allowed

GET is not allowed inside a program message.

-104 Data type error

Improper data type used (for example, string data was expected, but numeric data was received).

-103 Invalid separator

The message unit separator (for example, ";", ",", ") is improper.

-102 Syntax error

Unrecognized command or data type was received.

-101 Invalid character

Invalid character was received.

Index

Special characters

*****, 5-7, 8-6

⏏, 7-2

⏏, 7-2

Δ MODE MENU, 11-3

Δ MODE OFF, 11-6

Δ REF MARKER, 11-6

ΔREF=Δ FIXED MKR, 11-6

↑, 8-5

ⓧ, 7-2

Numbers

1/S, 9-4

3 term calibration, 10-2

3 TERM S11 1-PORT, 10-9

A

A, 9-3

Accessory, 1-1

ACTIVATE MARKER, 11-3

Active channel, 5-5, 6-1

Active channel key, 5-4, 6-1

Active Entry Area, 5-7

Active marker, 11-3, 11-4

ADD, 8-9, 12-22

ADDRCONT, 12-5

ADDRESS: 87510, 12-5

Addressable, 12-3, 15-3

ADDRESSABLE ONLY, 12-4

ADDRESS: CONTROLLER, 12-5

ADDRESS: PLOTTER, 12-5

ADDRESS: PRINTER, 12-5

ADDRPLOT, 12-5

ADDRPRIN, 12-5

ALL, 14-13

ALL BASIC, 9-17

ALL INSTRUMENT, 9-17

ALL MKR OFF, 11-3

AMPLITUDE OFFSET, 12-25

Aperture, 9-10

A/R, 9-3

AR, 9-3

AUTO, 9-12

AUTOREC, 14-5

Auto recall, 14-5

AUTO SCALE, 9-12

Auto sweep time, 8-5

Averaging, 4-4, 9-19

Averaging factor, 9-19, 9-21

AVERAGING FACTOR, 9-21

AVERAGING on OFF, 9-22

AVERAGING RESTART, 9-21, 9-22

AVERFACT, 9-21

AVEROFF, 9-22

AVERON, 9-22

AVERREST, 9-21

Avg, 5-7, 9-22

AVG, 9-1, 9-11, 9-19

B

BACK SPACE, 7-2

BACK SPACE, 9-18, 14-14

BASIC STATUS, 9-17

Battery backup, B-1

Beep, 12-27

BEEPDONEOFF, 9-16

BEEPDONEON, 9-16

BEEP DONE ON off, 9-16

BEEPFAILOFF, 12-21

BEEPFAILON, 12-21

BEEP FAIL on OFF, 12-21

BEEPWARNOFF, 9-16

BEEPWARNON, 9-16

BEEP WARN on OFF, 9-16

BINCEL, 12-16

BINL, 12-15

BIN LINE on OFF, 12-13

BINO, 12-15

BINOA, 12-13

BINOB, 12-13

BINP, 12-15

BINS, 12-13

BINSLINE, 12-13

BIN sort function, 12-11
BIN SORT MENU, 12-6
BIN SORT on OFF, 12-13
BIN SORT TABLE, 13-10
BINU, 12-15
Built-in Flexible Disk Drive, 5-4
Built-in power splitter, 4-2

C

C!, 5-7
C?, 5-7
CAL, 10-3
CAL ARY on OFF, 14-17
CALCASSI, 13-10
CALIBRATE MENU, 10-5
CALIBRATE: NONE, 10-9
Calibration, 10-1, 10-9
Calibration coefficients arrays, 14-2
Calibration kit, 10-11
CALIRAI, 10-9
CALIRESP, 10-9
CALIS111, 10-9
CALK7MM, 10-6
Cal kit, 10-11
CAL KIT, 10-6, 10-13
CAL KIT: 7mm, 10-6
CAL KIT DEFINITION, 13-10, 13-14
CALKN50, 10-6
CALKN75, 10-6
CALKUSED, 10-6
CALN, 10-9
CALs, 13-11
CENT, 8-1, 8-11
CENTER, 8-11
CH 1, 6-1
CH 2, 6-1
CHAD, 14-19
CHAN1, 6-1
CHAN2, 6-1
CHANGE DIRECTORY, 14-19
Channel coupling, 10-4
Class assignment, B-8
CLASS ASSIGNMENT, 13-10
CLEAR LIST, 8-9, 12-16
Clear list menu, 8-12, 12-24
CLEAR LIST YES, 8-12, 12-24
CLEAR MARKER, 11-3
Clear marker menu, 11-5
CLEL, 8-9, 8-12
CLEM1, 11-5

CLEM2, 11-5
CLEM3, 11-5
CLEM4, 11-5
CLEM5, 11-5
CLEM6, 11-5
CLEM7, 11-5
CLEM8, 11-5
Clock menu, 12-10
COMMAND ENTRY, 12-9
CONT, 8-6
CONTINUOUS, 8-6, 11-9
Controller, 15-2
CONV1DS, 9-4
CONVERSION, 9-3
Conversion menu, 9-3
CONVOFF, 9-4
CONVYTRA, 9-4
CONVZTRA, 9-4
COPA, 13-4, 13-13
COPTOFF, 13-4, 13-13
COPTON, 13-4, 13-13
Copy
 Address, 13-14
 Comment, 13-14
 Date, 13-14
 Plotter, 13-14
 Printer, 13-14
 Time, 13-14
 Title, 13-14
 Troubleshooting, 13-15
COPY, 12-10, 13-2, 13-14
COPY ABORT, 13-4, 13-13, 13-14
Copy cal kit menu, 13-10
COPY FILE, 14-19
Copy limit test menu, 13-12
Copy list sweep menu, 13-11
Copy menu, 13-4
Copy more menu, 13-8
Copy standard number menu, 13-11
COPY TIME, 12-10
COPY TIME on OFF, 13-4, 13-13
COPY TIME ON off, 13-14
Cor, 5-7
Correction menu, 10-5
CORRECTION on OFF, 10-5
CORROFF, 10-5
CORRON, 10-5
COUCOFF, 8-4
COUCON, 8-4
COUPLED CH on OFF, 8-4
CREATE DIRECTORY, 14-19
CRED, 14-19

Crosstalk, 10-9
CRT display, 5-4, 5-5
CTR & SPAN, 13-12

D

DATA & GRATCL, 13-6, 13-15
DATA ONLY, 13-6, 13-15
DATA ONLY (ASCII), 14-15
Data point, 4-2
DATE MM/DD/YY, 12-10
DATE MODE: MonDayYear, 12-10
DAY, 12-10
DayMonYear, 12-10
DAYMYEAR, 12-10
Default, B-1
DEFAULT SETUP, 13-4
DEFINE EXTENSION, 14-15
DEFINE PLOT, 13-5, 13-15
Define plot menu, 13-6
DEFINE SAVE DATA, 14-13, 14-15
Define save data menu, 14-17
DEFINE STANDARD, 10-14
Define standard menu, 10-15
Define standard number menu, 10-15
DEFS, 10-14
Del, 5-7
DELA, 9-6
DELAY, 9-6
DELETE, 8-9, 12-22
DELO, 11-6
DELR1, 11-7
DELR2, 11-7
DELR3, 11-7
DELR4, 11-7
DELR5, 11-7
DELR6, 11-7
DELR7, 11-7
DELR8, 11-7
DELRFIXM, 11-6
DELTA LIMITS, 12-23
Delta marker menu, 11-6
Delta marker mode, 11-1, 11-5
DFLT, 13-4
Directivity, 10-9
DISAALLB, 9-17
DISAALLI, 9-17
DISABASI, 9-17
DISAHIHB, 9-17
Disk capacity, 14-4
Disk copy, 14-23

Disk format, 14-4
Disk menu, 14-19
DISL1, 13-11
DISL2, 13-11
DISLLIST, 13-12
DISMCTSP, 13-12
DISMMD, 13-12
DISMNUM, 13-12
DISMSTEP, 13-12
DISMSTSP, 13-11
DISMUL, 13-12
DISPLAY, 9-1, 9-14
DISPLAY ALLOCATION, 9-15
Display allocation menu, 9-17
DISPLAY LIST, 13-12
DISPLAY: LIST1, 13-11
Display menu, 9-14
DISP MODE: ST & SP, 13-11
DISP MODE: UPR & LWR, 13-12
DUACOFF, 9-14
DUACON, 9-14
DUAL CHAN on OFF, 9-14
DUT, 4-1

E

EDIT, 8-9, 12-22
EDIT: , 8-9
EDITBINL, 12-14
EDIT BIN SORT LINE, 12-14
EDITDONE, 8-10
EDIT LIMIT LINE, 12-21, 12-26
Edit limits menu, 12-21
EDITLIML, 12-21
EDITLIS1, 8-9
EDITLIS2, 8-9
EDIT LIST, 8-8
EDITLIST, 8-8
Edit list menu, 8-9
Edit segment menu, 8-10, 12-22
ELEC DELAY MENU, 9-12
Electrical delay, 4-4, 9-12
ELECTRICAL DELAY, 9-13, 10-7
ELED, 9-13
Entry, 5-4, 7-1
ENTRY OFF, 7-2, 12-27
ERASE TITLE, 9-18, 14-14
EXPANDED PHASE, 9-7
Expanded Phase format, 9-7
EXPP, 9-7
Ext, 5-7
EXTENSION, 10-8

EXTENSIONS on OFF, 10-8
EXT PROG RUN/CONT connector, 5-8
EXT REF INPUT connector, 5-8
EXTTOFF, 8-6
EXTTON, 8-6
EXTTPOIN, 8-7
EXT TRIGGER connector, 5-8
EXT. TRIG ON POINT, 8-7
EXT. TRIG ON SWEEP, 8-6

F

Factory setting, B-1
FAIL message, 12-27
Fan, 5-9
FILC, 14-19
File name, 14-4
File size, 14-5
FILE UTILITIES, 14-13
Filter measurement, 12-25
Fixed marker menu, 11-7
FIXED MKR AUX VALUE, 11-8
FIXED MKR STIMULUS, 11-8
FIXED MKR VALUE, 11-8
Format, 5-6, 9-5
FORMAT, 9-1, 9-5
Format more menu, 9-8
FREQ, 9-16
FREQUENCY BLANK, 9-16
Frequency list mode, 8-7
Frequency response, 10-9
Front panel, 5-3
FULL PAGE, 13-5
FULP, 13-5
Fuse, 1-3

G

G, 7-2
G/n, 7-2
Go/no-go testing, 12-25
GRAPHICS, 14-15
GRODAPER, 9-22
Group delay, 9-9
GROUP DELAY APERTURE, 9-11, 9-22

H

HALF INSTR HALF BASIC, 9-17
Hard copy, 13-1
Hewlett-Packard Interface Bus, 12-3, 15-1
Hld, 5-7, 8-6
HOLD, 8-6
HOLD, 8-6

HOOR, 12-10
HP-HIL connector, 5-4
HP-IB, 5-3, 12-3, 15-1
HP-IB address, 15-4
HP-IB connector, 5-8

I

IBASIC, 12-6
IF bandwidth, 4-3, 9-20, 9-22, 9-23
IF BW, 8-11, 9-22
IFBW, 8-11, 9-22
IF BW AUTO, 9-23
IFBWAUTO, 9-23
IF (Intermediate frequency), 4-2
IMAG, 9-8
IMAGINARY, 9-8
Imaginary format, 9-8
Incoming Inspection, 1-1
INID, 14-19
Initialize, B-1
INITIALIZE DISK [], 14-19
Initialize menu, 14-21
INITIALIZE YES, 14-21
Input port menu, 9-2
inputs R and A, 5-4
Insertion loss, 12-28
Instrument BASIC, 12-7
Instrument data arrays, 14-2
Instrument state, 5-2
Instrument state data, 14-2
Instrument state function, 5-4, 12-1
Instrument states and internal data arrays,
14-3
Intensity, 5-4
Interpolated error correction, 8-7, 10-3
INT REF OUTPUT connector, 5-8
I/O port, 12-27
Isolation, 10-9
Isolation calibration, 10-4

K

K, 7-2
KEY 15, 10-3
KEY 17, 11-11
KEY 19, 8-2
KEY 24, 7-2
KEY 25, 7-2
KEY 26, 7-2
KEY 27, 7-2
KEY 41, 7-2
KEY 42, 7-2
KEY 43, 7-2
KITD, 10-14

KIT DONE, 10-14

(k/m), 7-2

L

LABEL CLASS, 10-14

Label class menu, 10-19

LABEL KIT, 10-14, 10-19

Label kit menu, 10-19

Label standard menu, 10-18

LABK, 10-14

LEFL, 13-5

LEFT LOWER, 13-5

LEFT UPPER, 13-5

LEFU, 13-5

LIF (logical inter change format), 14-4

LIMCLEL, 12-24

LIMD, 12-23

LIMIAMP0, 12-25

LIMILINEOFF, 12-20

LIMILINEON, 12-20

LIMIMAOF, 12-25

LIMIOPOIN, 12-21

LIMIOSEND, 12-21

LIMISTIO, 12-24

LIMITESTOFF, 12-20

LIMITESTON, 12-20

Limit line, 12-16

Limit line function, 12-25

 Check points, 12-28

 Editing display, 13-14

 Insertion loss testing, 12-28

 Lower limit, 12-25

 Segment, 12-25

 Segment order, 12-26

 Upper limit, 12-25

LIMIT LINE OFFSETS, 12-21

LIMIT LINE on OFF, 12-20

LIMIT LINE ON off, 12-26

LIMIT MENU, 12-6, 12-26

Limits menu, 12-20

Limit test, 12-16

Limit test function, 12-25

LIMIT TEST on OFF, 12-20

LIMIT TEST ON off, 12-27

LIMIT TEST TABLE, 13-10

LIML, 12-23

LIMM, 12-23

LIMS, 12-23

LIMSADD, 12-22

LIMSDEL, 12-22

LIMSDON, 12-23

LIMSEDI, 12-22

LIMU, 12-23

Linear frequency sweep mode, 8-7

LINE switch, 5-4

LINE TYPE DATA, 13-6

LINE TYPE MEMORY, 13-6

LIN FREQ, 8-7

LINFREQ, 8-7

LINM, 9-6

LIN MAG, 9-6

LINTDATA, 13-6

LINTMEMO, 13-6

LISDFBASE, 8-8

LISDOBASE, 8-8

LISFREQ, 8-7

LISSLIS1, 8-8

LISSLIS2, 8-8

LIST2, 13-11

LIST DISP: FREQ BASE, 8-8

LIST DONE, 8-10

Listener, 15-2

LIST FREQ [], 8-7

List sweep function

 Editing display, 13-14

List sweep menu, 8-8

LIST SWEEP TABLE, 8-8, 13-10

LIST VALUES, 13-8, 13-14

LISV, 13-8

LMT TST ON [], 12-21

(LOCAL), 12-2, 12-3

LOCAL MAX, 11-16

LOCAL MIN, 11-16

Local mode, 12-2

Logarithmic frequency sweep mode, 8-7

LOG FREQ, 8-7

LOGFREQ, 8-7

LOGM, 9-5

LOG MAG, 9-5

LOG MAG & DELAY, 9-7

Log magnitude and delay format, 9-8

Log magnitude and Phase Format, 9-7

LOG MAG & PHASE, 9-7

LOGMD, 9-7

LOGMP, 9-7

LOWER GRATICULE, 13-7

LOWER LIMIT, 12-15, 12-23

M

M, 7-2
MA, 7-2
man, 5-7, 8-7
MANTRIG, 8-7
Manual Changes, A-1
Manual sweep time, 8-5
MANUAL TRG ON POINT, 8-7
MARK1, 11-4
MARK2, 11-4
MARK3, 11-4
MARK4, 11-4
MARK5, 11-4
MARK6, 11-4
MARK7, 11-4
MARK8, 11-4
MARKCENT, 11-12
MARKCONT, 11-9
MARKCOUP, 11-9
MARKDISC, 11-9
Marker data readout, 5-6
MARKER: DISCRETE, 12-27
Marker function menu, 11-11
Marker list, 11-1
Marker menu, 11-3
Marker mode menu, 11-9
MARKER MODE MENU, 11-4, 12-27
MARKER → AMP. OFS., 12-25
MARKER → CENTER, 11-12
MARKER → DELAY, 9-13
MARKER → MIDDLE, 12-23
MARKER → REFERENCE, 9-12, 11-12
MARKER → SPAN, 11-12
MARKER → START, 11-12
MARKER → STIMULUS, 12-23
MARKER → STIMULUS, 12-27
MARKER → STOP, 11-12
MARKERS: COUPLED, 11-9
MARKERS: DISCRETE, 11-9
Marker Search menu, 11-14
MARKERS ON [DATA], 11-3
Marker statistics, width value, 5-6
Marker time mode, 11-1
MARKFAUV, 11-8
MARKFSTI, 11-8
MARKFVAL, 11-8
MARKLOFF, 11-3
MARKLON, 11-3
MARKMIDD, 12-23

MARKODATA, 11-3
MARKOFF, 11-3
MARKOMEMO, 11-3
MARKPEAD, 11-16
MARKREF, 9-12, 11-12
MARKSPAN, 11-12
MARKSTAR, 8-10, 11-12
MARKSTIM, 12-23
MARKSTOP, 8-11, 11-12
MARKTIMEOFF, 11-9
MARKTIMEON, 11-9
MARKUNCO, 11-9
MARKZERO, 11-3
MAX, 11-14
MEAS, 9-1, 9-2
MEASA, 9-3
MEASTATOFF, 11-12
MEASTATON, 11-12
Measured input, 5-5
MEASURE RESTART, 8-3
Memory trace arrays, 14-2
MENU, 8-2
Message area, 5-7
MIDDLE VALUE, 12-23
MID & DLT, 13-12
MIN, 11-14, 12-10
Minimum sweep time, 8-5
MKR, 11-1
MKR FCTN, 11-11
MKR LIST on off, 11-3
MKR → START, 8-10
MKR → STOP, 8-11
MKR SEARCH, 11-12
MKR TIME on OFF, 11-9
MKR ZERO, 11-3
M/μ, 7-2
MODI1, 10-6
MODIFY, 10-6, 10-13
Modify cal kit menu, 10-13
MONDYEAR, 12-10
MONTH, 12-10

N
N, 7-2
N 50Ω, 10-6
N 75Ω, 10-6
NEXP, 13-13
NEXT PAGE, 13-13
Non-volatile memory, B-1
NUMBER of GROUPS, 8-6

Number of points, 12-28
NUMBER of POINTS, 8-3, 8-11, 13-12
NUMG, 8-6

O

OFF, 9-4
OFFSET DELAY, 10-17
Offset limit menu, 12-24
OFFSET LOSS, 10-18
OFFSET ZO, 10-18
OFSD, 10-17
OFSL, 10-18
OFSZ, 10-18
Omitting isolation calibration, 10-4
OPEP, 13-9
Operating conditions, 1-2
OPERATING PARAMETERS, 13-9, 13-14
Option 001, 1-1, 1-4, 5-9
OPTION 006, C-1
ORDER BASE, 8-8
OUT OF LMT PATTERN, 12-15
OUTPUT PATTERN, 12-15
Output power level, 8-3
OUTPUT TO , 12-13

P

Parallel I/O, C-1
PARSOFF, 11-13
PARSON, 11-13
PART SRCH on OFF, 11-13
Pass/Fail, 5-6
PASS/FAIL output signal, C-3
PASS message, 12-27
P₁, 5-7
PEADX, 11-16
PEADY, 11-16
PEAK DEF: ΔX(Y), 11-16
PEAK-PEAK, 11-16
PHAO, 9-13
PHAS, 9-5
PHASE, 9-5
PHASE OFFSET, 9-13
PLOALL, 13-6
PLODGRAT, 13-6
PLODONLY, 13-6
PLOSFAST, 13-7
PLOSSLOW, 13-7
PLOT, 13-4, 13-13
PLOT, 13-4, 13-13
PLOT: ALL, 13-6, 13-15

PLOT SPEED, 13-7
Plotting, 13-14
POIN, 8-3
Point, 4-2
POINT, 8-11
POLA, 9-8
POLAR, 9-8
Polar marker menu, 11-10
POLAR MKR MENU, 11-9
POLMLIN, 11-10
POLMLOG, 11-10
POLMRI, 11-10
POREOFF, 10-8
POREON, 10-8
Port A, C-1
PORTA, 10-8
Port B, C-1
Port C, C-1
Port D, C-1
Port E, C-2
PORT EXTENSIONS, 10-7
Port F, C-2
Port G, C-2
Port H, C-2
PORTR, 10-8
POWE, 8-3, 8-11
POWER, 8-3
Power Cable, 1-3
power splitter, 4-2
PREP, 13-13
(PRESET), 5-4, B-1
Preset state, B-1
PREV FILES, 14-18
PREV PAGE, 13-13
PRINALL, 13-4, 13-13
PRINT, 13-13
PRINT [color], 13-14
Printing, 13-14
PRINT/PLOT SETUPS, 13-13, 13-14
PRINT [STANDARD], 13-4, 13-14
PURG, 14-19
PURGE FILE, 14-19
Purge file menu, 14-20
PURGE: YES, 14-21

R

REAL, 9-8
REAL, 9-8
Real format, 9-8
Rear panel, 5-8
(RECALL), 14-11

Recall file menu, 14-22
Recharge time, B-1
Reference level, 5-6
Reference plane menu, 10-8
REFERENCE POSITION, 9-12
REFERENCE VALUE, 9-12
REF OVEN (Option 001) connector, 5-9
REFP, 9-12
REFV, 9-12
Remote mode, 12-2
RESAVD, 14-13
RE-SAVE FILE, 14-13
Re-save file menu, 14-18
RESC, 10-5
RESD, 13-13
Response, 5-2
RESPONSE, 10-9, 10-19
Response and isolation calibration, 10-2,
10-10, 10-19
Response calibration, 10-2, 10-10, 10-19
Response function, 5-4, 9-1
RESPONSE & ISOL'N, 10-9, 10-19
REST, 8-3
RESTORE DISPLAY, 13-13
RESUME CAL SEQUENCE, 10-5
RF OUT connector, 5-4
RIGHT LOWER, 13-5
RIGHT UPPER, 13-5
RIGL, 13-5
RIGU, 13-5
RMT, 5-7

S

S₁₁ 1-port calibration, 10-19
S11B, 10-19
S11C, 10-19
SADD, 8-9
SAVCAOFF, 14-17
SAVCAON, 14-17
SAVDAL, 14-13
SAVDASC, 14-15
SAVDDAT, 14-13
SAVDGRA, 14-15
SAVDSTA, 14-13
SAVE, 12-28, 14-11
SAVE DATA ONLY, 14-13
SAVE FILE, 14-13
SAVE STATE ONLY, 14-13
SAVEUSEK, 10-6
SAVE USER KIT, 10-6, 10-14
SAVTAOFF, 14-17

SAVTAON, 14-17
SAVTMAOFF, 14-17
SAVTMAON, 14-17
SCAFDATA, 9-12
SCAFMEMO, 9-12
SCAL, 9-12
Scale/Div, 5-6
SCALE/DIV, 9-12
SCALE FOR, 9-12
SCALE: FULL, 13-7
SCALE PLOT, 13-6
Scale plot menu, 13-7
SCALE REF, 9-1, 9-11
Scale reference menu, 9-11
SCAPFULL, 13-7
SCAPGL, 13-7
SCAPGU, 13-7
Screen menu, 13-13
SDEL, 8-9
SDON, 8-11
SEAL, 11-15
SEALMAX, 11-16
SEALMIN, 11-16
SEAMAX, 11-14
SEAMEAN, 11-16
SEAMIN, 11-14
SEAOFF, 11-14
SEAPPEAK, 11-16
SEAR, 11-15
SEARCH IN, 11-18
SEARCH LEFT, 11-15
SEARCH: MEAN, 11-16
SEARCH: OFF, 11-14
SEARCH OUT, 11-18
SEARCH RANGE, 11-12
Search Range menu, 11-13
SEARCH RIGHT, 11-15
SEARCH RNG STORE, 11-13
SEARSTOR, 11-13
SEATARG, 11-14, 11-15
SEC, 12-10
SEDI, 8-9
Segment, 12-18
SEGMENT, 8-9, 12-22
SEGMENT DONE, 8-11
SEGMENT:POWER, 8-11
SEGMENT START, 8-11
Select cal kit menu, 10-6
SELECT LETTER, 9-18, 14-14

SELECT QUADRANT, 13-5
 Serial number plate, 5-8
SERVICE MENU, 12-6
SET ADDRESSES, 12-4
SETCDATE, 12-10
SET CLOCK, 12-6
SETCTIME, 12-10
 Set date menu, 12-10
 Set time menu, 12-10
SETZ, 10-7
SET Z0, 10-7
SING, 8-6
SINGLE, 8-6
 Smo, 5-7, 9-22
SMOOPER, 9-22
SMOOFF, 9-22
SMOON, 9-22
 Smoothing, 4-5, 9-20
 Smoothing aperture, 9-22
SMOOTHING APERTURE, 9-22
SMOOTHING on OFF, 9-22
 Softkey, 5-4
 Softkey label, 5-6
SPACE, 9-18, 14-14
SPAN, 8-1, 8-11
SPAN, 8-1
SPAN, 8-11
SPCL FCTN, 9-1, 9-24
SPECIFY CLASS, 10-14
 Specify class menu, 10-18
 Specify offset menu, 10-17
SPECIFY S11A, 10-19
SPECRESI, 10-19
SPECRESP, 10-19
SPECS11A, 10-19
SPECS11B, 10-19
SPECS11C, 10-19
SPLDOFF, 9-14
SPLDON, 9-14
 Split display, 9-14
SPLIT DISP on OFF, 9-14
SPLIT DISP ON off, 9-14
 Standard class assignment, B-8
STANDARD DEFINITION, 13-10
 Standard device, 10-6
 Standard kit, B-6
STAR, 8-1, 8-11
START, 8-1
STATISTICS, 11-12
 Status output, C-2
STD DONE(DEFINED), 10-17

STD NO. n, 10-15, 13-11
STDTARBI, 10-17
STDTDELA, 10-17
STDTLOAD, 10-17
STDTOPEN, 10-16
STDTSHOR, 10-17
STEP SIZE, 8-11, 13-12
 Stimulus, 4-2, 5-2, 8-3
 Stimulus function, 5-4, 8-1
STIMULUS OFFSET, 12-24
 Stimulus start value, 5-6
 Stimulus stop value, 5-6
STIMULUS VALUE, 12-23
STODDISK, 14-13, 14-14
STODMEMO, 14-13, 14-14
STOP, 8-11
STOP, 8-1
STOP, 8-11
STOR DEV , 14-13, 14-14
STPSIZ, 8-11
SUB ARY on OFF, 14-17
 Svc, 5-7
 Sweep, 4-2, 8-7
SWEEP by:, 8-8
 Sweep end output signal, C-3
SWEEP TIME, 8-5
SWEEP TIME [], 8-3
SWEEP TIME AUTO, 8-5
 Sweep time menu, 8-5
SWEEP TYPE MENU, 8-4
SWET, 8-5
SWETAUTO, 8-5
SYSTEM, 12-6
 System controller, 12-3, 15-2, 15-3
SYSTEM CONTROLLER, 12-4, 13-14

T

Tabular format, 13-14
 Talker, 15-2
TARGET, 11-14, 11-15
 Target menu, 11-15
TERI, 10-17
TERMINAL IMPEDANCE, 10-17
TIME HH:MM:SS, 12-10
TITL, 9-15
 Title, 5-7, 9-18, 14-14
TITLE, 9-15, 13-14
 Trace arrays, 14-2
TRACE ARY on OFF, 14-17
TRACE on OFF, 9-15

TRACKING on OFF, 11-14
TRACKOFF, 11-14
TRACKON, 11-14
TRADOFF, 9-15
TRADON, 9-15
Trigger menu, 8-6
TRIGGER MENU, 8-3
TRIGGER: TRIG OFF, 8-6

U

U, 7-2
UNCOUPLED, 11-9
UPPER GRATICULE, 13-7
UPPER LIMIT, 12-15, 12-23
User-defined cal kit, 10-11
USER KIT, 10-6

V

VELOCITY FACTOR, 10-7
VELOFACT, 10-7

W

WIDSIN, 11-18
WIDSON, 11-18
Width menu, 11-17
WIDTHS on OFF, 11-18
WIDTH VALUE, 11-17
WIDTOFF, 11-18
WIDTON, 11-18
WIDV, 11-17
Write strobe, C-2

Y

YEAR, 12-10
Y: Trans, 9-4

Z

Z: Trans, 9-4

HP 87510A Gain Phase Analyzer
HP-IB Programming Manual



Printed in Japan December 1991

Notice

The information contained in this document is subject to change without notice.

This document contains proprietary information which is protected by copyright. All rights are reserved. No part of this document may be photocopied, reproduced, or translated to another language without the prior written consent of the Hewlett-Packard Company.

Customer shall have the personal, non-transferable rights to use, copy or modify SAMPLE PROGRAM in this manual for Customer's internal operations. Customer shall use the SAMPLE PROGRAM solely and exclusively for its own purpose and shall not license, lease, market or distribute the SAMPLE PROGRAM or modification or any part thereof.

HP shall not be liable for the quality, performance or behavior of the SAMPLE PROGRAM. HP especially disclaims that the operation of the SAMPLE PROGRAM shall be uninterrupted of error free. This SAMPLE PROGRAM is provided AS IS.

HP DISCLAIMS THE IMPLIED WARRANTIES OF MERCHANTABILITY AND FITNESS FOR A PARTICULAR PURPOSE.

HP shall not be liable for any infringement of any patent, trademark, copyright or other proprietary rights by the SAMPLE PROGRAM or its use. HP does not warrant that the SAMPLE PROGRAM is free from infringements or such rights of third parties. However, HP will not knowingly infringe or deliver a software that infringes the patent, trademark, copyright or other proprietary right of a third party

MS-DOS[®] is a U.S. registered trademark of Microsoft Corporation.

© Copyright 1991, Yokogawa-Hewlett-Packard, LTD.

Manual Printing History

The manual printing date and part number indicate its current edition. The printing date changes when a new edition is printed. (Minor corrections and updates which are incorporated at reprint do not cause the date to change.) The manual part number changes when extensive technical changes are incorporated.

December 1991. . . . 1st. Edition



Contents

1. Guide of HP-IB Programming Manual	
2. Programming Basics	
<i>Preparing for HP-IB Control</i>	2-1
<i>Required Equipment</i>	2-1
<i>Optional Equipment</i>	2-1
<i>Powering Up the System</i>	2-2
<i>Measurement Programming</i>	2-3
<i>Basic Programming Examples</i>	2-5
<i>Setting Up a Measurement</i>	2-5
<i>Performing a THRU Calibration</i>	2-7
<i>Frequency Response Calibration</i>	2-7
<i>Data Transfer from the HP 87510A to a Computer</i>	2-9
<i>Using Markers to Obtain Trace Data at Specific Points</i>	2-9
<i>Trace Transfer</i>	2-11
<i>Data Format</i>	2-11
<i>Data Levels</i>	2-12
<i>Data Transfer Using ASCII Transfer Format (Form 4)</i>	2-14
<i>Data Transfer using IEEE 64-bit Floating Point Format (Form 3)</i>	2-15
<i>Application Example</i>	2-17
<i>Advanced Programming Examples</i>	2-19
<i>Using List Frequency Mode</i>	2-19
<i>Using Limit Lines to Perform Limit Testing</i>	2-22
<i>Storing and Recalling Instrument States</i>	2-25
<i>Coordinating disk storage</i>	2-25
<i>Reading Calibration Data</i>	2-26
<i>Miscellaneous Programming Examples</i>	2-29
<i>Controlling Peripherals</i>	2-29
<i>Transferring disk data files</i>	2-31
<i>Status Reporting</i>	2-33
3. HP-IB Programming Reference	
<i>HP-IB Command Syntax</i>	3-1
<i>Query Commands</i>	3-2
<i>Suffix</i>	3-3
<i>Code Naming Conventions</i>	3-3
<i>HP 87510A Instrument Command Reference</i>	3-4
<i>ADDRCONT value</i>	3-4
<i>ADDRPLOT value</i>	3-4
<i>ADDRPRIN value</i>	3-4
<i>ANAOCHI</i>	3-4
<i>ANAOCH2</i>	3-4
<i>ANAODATA</i>	3-4
<i>ANAOMEMO</i>	3-4
<i>ANARANG value[suffix], value[suffix]</i>	3-4
<i>ANARFULL</i>	3-5

AR	3-5
ASCE string	3-5
AUTO	3-5
AVER {ON OFF}	3-5
AVERFACT value	3-5
AVERREST	3-5
BEEPDONE {ON OFF}	3-5
BEEPFAIL {ON OFF}	3-6
BEEPWARN {ON OFF}	3-6
BINCLEL	3-6
BINEDONE	3-6
BINESB value	3-6
BINL value	3-6
BINO value	3-6
BINOA	3-7
BINO B	3-7
BINP value	3-7
BINS {ON OFF}	3-7
BINSADD	3-7
BINSDEL	3-7
BINSDON	3-7
BINSEDI value	3-7
BINSLINE {ON OFF}	3-8
BINU value[suffix]	3-8
C0 value	3-8
C1 value	3-8
C2 value	3-8
CALCASSI	3-8
CALI parameter	3-9
CALIRAI	3-9
CALIRESP	3-9
CALIS111	3-9
CALK parameter	3-9
CALK7MM	3-9
CALKN50	3-9
CALKN75	3-10
CALKUSED	3-10
CALN	3-10
CALS value	3-10
CENS value1 [suffix], value2 [suffix]	3-10
CENT value [suffix]	3-10
CHAD string	3-10
CHANI	3-11
CHAN2	3-11
CIN	3-11
CLAD	3-11
CLASS11 {A B C}	3-11
CLEL	3-11
CLEM {1-8}	3-11
CLES	3-11
CONT	3-11
CONV parameter	3-12
CONVIDS	3-12
CONVMP {4 8 16}	3-12
CONVOFF	3-12

CONVYTRA	3-12
CONVZTRA	3-12
COPA	3-12
COPT {ON OFF}	3-13
CORR {ON OFF}	3-13
COUC {ON OFF}	3-13
COUT	3-13
CRED string	3-13
CURD?	3-13
DATAMSTER	3-13
DATAMNONE	3-14
DATAMTHRU	3-14
DAYMYEAR	3-14
DCBUS value	3-14
DEFS value	3-14
DELA	3-14
DELO	3-14
DELR {1-8}	3-15
DELRFIXM	3-15
DESTOFF	3-15
DESTON	3-15
DFLT	3-15
DIN	3-15
DISA parameter	3-15
DISAALLB	3-15
DISAALLI	3-16
DISABASS	3-16
DISAHIHB	3-16
DISBLIST	3-16
DISFDOS	3-16
DISFLIF	3-16
DISG {ON OFF}	3-16
DISL {1 2}	3-16
DISLLIST	3-17
DISMCTSP	3-17
DISMMD	3-17
DISMNUM	3-17
DISMSTEP	3-17
DISMSTSP	3-17
DISMUL	3-17
DISP parameter	3-17
DISPDATA	3-18
DISPDATM	3-18
DISPDDM	3-18
DISPDMM	3-18
DISPMEMO	3-18
DIST {ON OFF}	3-18
DONE	3-18
DOUT	3-18
DSKEY	3-18
DUAC {ON OFF}	3-18
EDITBINL	3-19
EDITDONE	3-19
EDITLIML	3-19
EDITLISI	3-19

EDITLIS2	3-19
EDITLIST	3-19
ELED value [s]	3-19
ENKEY	3-19
EQUCPARA?	3-20
EQUCPARS?	3-20
ESB?	3-20
ESNB value	3-20
EXET	3-20
EXPP	3-20
EXTRLOCK?	3-20
EXTT parameter	3-20
EXTTOFF	3-21
EXTTON	3-21
EXTTPOIN	3-21
FBUS value	3-21
FILC string1,string2,string3,string4	3-21
FIRLPNOR	3-21
FIRLPOPE	3-21
FIRR?	3-22
FMT parameter	3-22
FNDAUTO	3-22
FNDMANU	3-22
FNDVALU value	3-22
FNVNARR	3-22
FNVNORM	3-22
FNVOPEN	3-23
FNVWIDE	3-23
FORM2	3-23
FORM3	3-23
FORM4	3-23
FORM5	3-23
FREQ	3-23
FULP	3-23
GRAE string	3-23
GRODAPER value [pct]	3-24
HOLD	3-24
IFBW value [suffix]	3-24
IFBWAUTO	3-24
IFRAUTO	3-24
IFRCH?	3-24
IFRX1	3-24
IFRX1X8	3-25
IFRX64	3-25
IFRX8X1	3-25
IMAG	3-25
INID	3-25
INP8IO	3-25
INP8IO?	3-25
INPT?	3-25
INPUCALC {01-03} value	3-26
INPUCALK value	3-26
INPUD	3-26
INPUDATTP value1,value2[suffix]	3-26
INPUDATM1 value	3-26

<i>INPU</i> ATM2 value	3-26
<i>INPU</i> ATM3 value	3-26
<i>INPU</i> ATM4 value	3-27
<i>INPU</i> FORM value	3-27
<i>INPU</i> LOAA value	3-27
<i>INPU</i> MEM value	3-27
<i>INPU</i> MEMTP	3-27
<i>INPU</i> OEPA value	3-27
<i>INPU</i> SHOA value	3-27
<i>INPU</i> TMEM value	3-27
<i>IOPO</i> ?	3-28
<i>KEY</i> value	3-28
<i>KTTD</i>	3-28
<i>LABERES</i> {I P} string	3-28
<i>LABES11</i> {A B C} string	3-28
<i>LABK</i> string	3-28
<i>LABS</i> string	3-28
<i>LEFL</i>	3-29
<i>LEFU</i>	3-29
<i>LIMCLEL</i>	3-29
<i>LIMD</i> value [suffix]	3-29
<i>LIMEDONE</i>	3-29
<i>LIMI</i> AMPO value [suffix]	3-29
<i>LIMILINE</i> {ON OFF}	3-30
<i>LIMMAOF</i>	3-30
<i>LIMIOPOIN</i>	3-30
<i>LIMIOSEND</i>	3-30
<i>LIMISTIO</i> value [suffix]	3-30
<i>LIMITEST</i> {ON OFF}	3-30
<i>LIML</i> value [suffix]	3-30
<i>LIMM</i> value [suffix]	3-31
<i>LIMS</i> value [suffix]	3-31
<i>LIMSADD</i>	3-31
<i>LIMSDEL</i>	3-31
<i>LIMSDON</i>	3-31
<i>LIMSEDI</i> value	3-31
<i>LIMU</i> value [suffix]	3-32
<i>LINFREQ</i>	3-32
<i>LINM</i>	3-32
<i>LINT</i> {DATA MEMO} value	3-32
<i>LISDFBASE</i>	3-32
<i>LISDOBASE</i>	3-32
<i>LISFREQ</i>	3-32
<i>LISLIS1</i>	3-33
<i>LISLIS2</i>	3-33
<i>LISV</i>	3-33
<i>LMAX?</i> value	3-33
<i>LMIN?</i> value	3-33
<i>LOGFREQ</i>	3-33
<i>LOGM</i>	3-33
<i>LOGMD</i>	3-33
<i>LOGMP</i>	3-34
<i>MANTRIG</i>	3-34
<i>MARD</i> {ON OFF}	3-34
<i>MARK</i> {1-8} value [suffix]	3-34

MARK {STAR STOP}	3-34
MARKBUCK value	3-34
MARKCENT	3-34
MARKCONT	3-34
MARKCOUP	3-35
MARKDISC	3-35
MARKFAUV value [suffix]	3-35
MARKFSTI value [suffix]	3-35
MARKFVAL value [suffix]	3-35
MARKL {ON OFF}	3-35
MARKMIDD	3-36
MARKODATA	3-36
MARKOFF	3-36
MARKOMEMO	3-36
MARKPEAD	3-36
MARKREF	3-36
MARKSPAN	3-36
MARKSTIM	3-36
MARKTIME {ON OFF}	3-37
MARKUNCO	3-37
MARKZERO	3-37
MEAS parameter	3-37
MEASA	3-37
MEASR	3-37
MEASTAT {ON OFF}	3-37
MODII	3-38
MONDYEAR	3-38
NEGL	3-38
NEXP	3-38
NEXPK?	3-38
NUMG value	3-38
NUMLMAX?	3-38
NUMLMIN?	3-38
OFS value [s]	3-39
OFSL value	3-39
OFSZ value [ohm]	3-39
OPEP	3-39
OPTI?	3-39
OSE value	3-39
OSER?	3-39
OSNT	3-39
OSPT	3-40
OSR?	3-40
OUT1ENVH	3-40
OUT1ENVL	3-40
OUT1H	3-40
OUT1L	3-40
OUT2ENVH	3-40
OUT2ENVL	3-40
OUT2H	3-40
OUT2L	3-40
OUT8IO value	3-40
OUTAIO value	3-41
OUTBIO value	3-41
OUTCIO value	3-41

<i>OUTDIO value</i>	3-41
<i>OUTEIO value</i>	3-41
<i>OUTFIO value</i>	3-41
<i>OUTGIO value</i>	3-41
<i>OUTHIO value</i>	3-41
<i>OUTPCALC {01-03}?</i>	3-41
<i>OUTPCALK?</i>	3-42
<i>OUTPCFIL? value1,value2,value3,value4,value5,value6</i>	3-42
<i>OUTPDATAT?</i>	3-42
<i>OUTPDATTP?</i>	3-42
<i>OUTPERRO?</i>	3-42
<i>OUTPFAIP?</i>	3-42
<i>OUTPFBUS?</i>	3-42
<i>OUTPFILT? value[suffix]</i>	3-43
<i>OUTPFORM?</i>	3-43
<i>OUTPFORMP? value</i>	3-43
<i>OUTPIFORM?</i>	3-43
<i>OUTPINP8IO?</i>	3-43
<i>OUTPINPCIO?</i>	3-43
<i>OUTPINPDIO?</i>	3-43
<i>OUTPINPEIO?</i>	3-43
<i>OUTPIRFORM?</i>	3-43
<i>OUTPIRTMEM?</i>	3-43
<i>OUTPITMEM?</i>	3-44
<i>OUTPLIMF?</i>	3-44
<i>OUTPLIML?</i>	3-44
<i>OUTPLIMM?</i>	3-44
<i>OUTPMARK?</i>	3-44
<i>OUTPMAX?</i>	3-44
<i>OUTPMEAN?</i>	3-44
<i>OUTPMEMO?</i>	3-44
<i>OUTPMEMOT?</i>	3-44
<i>OUTPMEMTP? value</i>	3-44
<i>OUTPMIN?</i>	3-45
<i>OUTPMINMAX?</i>	3-45
<i>OUTPMSTA?</i>	3-45
<i>OUTPMWID?</i>	3-45
<i>OUTPMWIL?</i>	3-45
<i>OUTPMWLF?</i>	3-45
<i>OUTPRESF? value1,value2</i>	3-45
<i>OUTPRESO?</i>	3-45
<i>OUTPRESR?</i>	3-46
<i>OUTPRFORM?</i>	3-46
<i>OUTPRTMEM?</i>	3-46
<i>OUTPSTIM?</i>	3-46
<i>OUTPTESS? value</i>	3-46
<i>OUTPTITL?</i>	3-46
<i>OUTPTMEM?</i>	3-46
<i>OUTPTMEMP? value</i>	3-46
<i>OUTPXFIL? value1,value2,value3,value4,value5</i>	3-46
<i>PARS {ON OFF}</i>	3-47
<i>PEADX value [suffix]</i>	3-47
<i>PEADY value [suffix]</i>	3-47
<i>PEAK?</i>	3-47
<i>PHAO value [deg]</i>	3-47

PHAS	3-47
PLOALL	3-48
PLOC parameter	3-48
PLODGRAT	3-48
PLODONLY	3-48
PLOS {FAST SLOW}	3-48
PLOT	3-48
POIN value	3-48
POLA	3-49
POLE? value	3-49
POLM parameter	3-49
POLMLIN	3-49
POLMLOG	3-49
POLMRI	3-49
PORE {ON OFF}	3-49
PORTA value [s]	3-50
PORTR value [s]	3-50
POSL	3-50
POWE value [dBm]	3-50
PREP	3-50
PRES	3-50
PRINALL	3-50
PSOFT {ON OFF}	3-50
PURG string	3-51
QUAD parameter	3-51
RAID	3-51
RAISOL	3-51
RAIRESP	3-51
REAL	3-51
RECCOFF	3-51
RECCON	3-52
RECD string	3-52
REFP value	3-52
REFV value [suffix]	3-52
RESAVD string	3-52
RESC	3-52
RESD	3-53
RESPDONE	3-53
REST	3-53
RFOPNORM	3-53
RFOPEN	3-53
RIGL	3-53
RIGU	3-53
RPLENV?	3-53
RPLHEI?	3-54
RPLLHEI?	3-54
RPLMEA?	3-54
RPLPP?	3-54
RPLRHEI?	3-54
RPLVAL?	3-54
SADD	3-54
SAVI	3-54
SAVC	3-55
SAVCA {ON OFF}	3-55
SAVDALL string	3-55

SAVDASC "string"	3-55
SAVDDAT string	3-55
SAVDGRA "string"	3-55
SAVDSTA string	3-55
SAVEUSEK	3-56
SAVTA {ON OFF}	3-56
SAVTMA {ON OFF}	3-56
SCAC	3-56
SCAFDATA	3-56
SCAFMEMO	3-56
SCAL value [suffix]	3-56
SCAPFULL	3-57
SCAPGL	3-57
SCAPGU	3-57
SCAU	3-57
SDEL	3-57
SDON	3-57
SEAL	3-57
SEALMAX	3-57
SEALMIN	3-58
SEAM parameter	3-58
SEAMAX	3-58
SEAMEAN	3-58
SEAMIN	3-58
SEAOFF	3-58
SEAPPEAK	3-58
SEAR	3-59
SEARSTOR	3-59
SEATARG value [suffix]	3-59
SEDI value	3-59
SELD	3-59
SETGDATE year, month, day	3-59
SETCTIME hour, min, sec	3-60
SETZ value [ohm]	3-60
SING	3-60
SMOO {ON OFF}	3-60
SMOOPER value [pct]	3-60
SOUCOFF	3-60
SOUCON	3-60
SPAN value [suffix]	3-61
SPECRESI value, [value, [value, [value, [value, [value, [value]]]]]]	3-61
SPECRESP value, [value, [value, [value, [value, [value, [value]]]]]]	3-61
SPECSI1A value, [value, [value, [value, [value, [value, [value]]]]]]	3-61
SPECSI1B value, [value, [value, [value, [value, [value, [value]]]]]]	3-61
SPECSI1C value, [value, [value, [value, [value, [value, [value]]]]]]	3-61
SPLD {ON OFF}	3-62
STAN {A-C}	3-62
STAR value [suffix]	3-62
STAS value1 [suffix], value2 [suffix]	3-62
STDD	3-62
STDT parameter	3-62
STDTARBI	3-63
STDTDELA	3-63
STDTLOAD	3-63
STDTOPEN	3-63

<i>STDTSHOR</i>	3-63
<i>STIDROUT</i> parameter value [suffix]	3-63
<i>STIMROUT</i> parameter value [suffix]	3-63
<i>STODDISK</i>	3-64
<i>STODMEMO</i>	3-64
<i>STOP</i> value [suffix]	3-64
<i>STPSIZE</i> value [suffix]	3-64
<i>SWET</i> value [s]	3-64
<i>SWETAUTO</i>	3-64
<i>SWPT</i> parameter	3-64
<i>TARL?</i> value	3-65
<i>TARR?</i> value	3-65
<i>TERI</i> value [ohm]	3-65
<i>TESC</i>	3-65
<i>TEST</i> value	3-65
<i>THRR</i> value	3-65
<i>TITL</i> string	3-66
<i>TRACK</i> {ON OFF}	3-66
<i>VELOFACT</i> value	3-66
<i>WIDSIN</i>	3-66
<i>WIDSOUT</i>	3-66
<i>WIDT</i> {ON OFF}	3-66
<i>WIDV</i> value [suffix]	3-66
* <i>CLS</i>	3-67
* <i>ESE</i> value	3-67
* <i>ESR?</i>	3-67
* <i>IDN?</i>	3-67
* <i>OPC</i>	3-67
* <i>PCB</i> value	3-67
* <i>RST</i>	3-67
* <i>SRE</i> value	3-67
* <i>STB?</i>	3-67
* <i>TRG</i>	3-67
* <i>TST?</i>	3-67
* <i>WAI</i>	3-67

A. HP-IB Commands Summary

<i>Active Channel Block</i>	A-1
<i>Response Function Block</i>	A-1
MEAS Key	A-1
<i>Input Port Menu</i>	A-1
<i>Conversion Menu</i>	A-1
FORMAT Key	A-2
<i>Format Menu</i>	A-2
<i>Format More Menu</i>	A-2
SCALE REF Key	A-2
<i>Scale Reference Menu</i>	A-2
<i>Electrical Delay Menu</i>	A-2
DISPLAY Key	A-2
<i>Display Menu</i>	A-2
<i>Display More Menu</i>	A-3
<i>Display Allocation Menu</i>	A-3
AVG Key	A-3
<i>Average Menu</i>	A-3
<i>IF Bandwidth Menu</i>	A-3

CAL Key	A-3
Correction Menu	A-3
Select Cal Kit Menu	A-3
Calibrate More Menu	A-4
Reference Plane Menu	A-4
Calibration Menu	A-4
Response Cal Menu	A-4
Response and Isolation Cal Menus	A-4
3-Term Cal Menus	A-4
Modify Cal Kit Menu	A-4
Define Standard Menu	A-4
Specify Offset Menu	A-5
Specify Class Menus	A-5
Label Class Menus	A-5
MKR Key	A-5
Marker Menu	A-5
Active Marker Menu	A-6
Clear Marker Menu	A-6
Delta Marker Mode Menu	A-6
Delta Marker Menu	A-6
Fixed Marker Menu	A-6
Marker Mode Menu	A-6
Polar Marker Menu	A-6
MKR FCTN Key	A-6
Marker Function Menu	A-6
Search Range Menu	A-7
Marker Search Menu	A-7
Target Menu	A-7
Marker Search More Menu	A-7
Width Menu	A-7
SPCL FNCT Key	A-7
Special Function Menu	A-7
Waveform Analysis Setting Menu	A-8
Stimulus Function Block	A-8
MENU Key	A-8
Stimulus Menu	A-8
Sweep Time Menu	A-8
Trigger Menu	A-8
Sweep Type Menu	A-9
List Sweep Menu	A-9
Edit List Menu	A-9
Edit Segment Menu	A-9
Edit Segment More Menu	A-9
Clear List Menu	A-9
Instrument State Function Block	A-10
SYSTEM Key	A-10
Real Time Clock Menu	A-10
BIN Sort Menu	A-10
BIN Sort Edit Menu	A-10
BIN Sort Table Edit Menu	A-10
Clear Menu	A-10
Limits Menu	A-10
Edit Limits Menu	A-11
Edit Segment Menu	A-11
Clear List Menu	A-11

Offset Limit Menu	A-11
LOCAL Key	A-11
PRESET Key	A-11
COPY Key	A-12
Copy Menu	A-12
Select Quadrant Menu	A-12
Define Plot Menu	A-12
Scale Plot Menu	A-12
Copy More Menu	A-12
Copy Cal Kit Menu	A-12
Copy Standard Number Menu	A-13
Copy List Sweep Menu	A-13
Copy Limit Test Menu	A-13
Screen Menu	A-13
SAVE and RECALL Keys	A-13
Save Menu	A-13
Title Menu	A-13
ASCII Save Menu	A-14
Define Extension Menu	A-14
Define Save Data Menu	A-14
Disk Menu	A-14
Recall Menu	A-14
Service Function	A-15
IEEE 488.2 Common Commands	A-15
Commands Which Don't Have Equivalent Softkey Labels	A-16

B. Status Reporting

OSPT, OSNT	B-5
OSPT (Operational Status Positive Transition Filter)	B-5
OSNT (Operational Status Negative Transition Filter)	B-5

C. Key Codes

D. Calibration Types and Standard Classes, and Calibration Arrays

E. Waveform Analysis Commands

Setting Commands for Waveform Analysis	E-1
ANARANG and ANARFULL	E-1
ANAOCH1/ANAOCH2	E-2
ANAOCH1/ANAOCH2	E-2
ANAOCH1/ANAOCH2	E-2
THRR	E-2
Ripple Analysis Command	E-2
RPLPP?	E-3
RPLHEI?	E-4
RPLRHEI? and RPLLHEI?	E-5
RPLENV?	E-6
RPLMEA?	E-7
RPLVAL?	E-8
POLE?	E-8
Maximum/Minimum/Mean Value Search Command	E-9
OUTPMAX?/OUTPMIN?/OUTPMINMAX?	E-9
OUTPMEAN?	E-10
PEAK?	E-10
NEXPK?	E-10
NUMLMAX?	E-10

NUMLMIN?	E-10
LMAX?	E-10
LMIN?	E-10
TARR?	E-10
TARL?	E-10
<i>Filter and Resonator Analysis Command</i>	E-11
OUTPFILT? value[suffix]	E-11
OUTPXFIL?	E-12
OUTPCFIL?	E-13
OUTPRESO?	E-14
OUTPRESR?	E-16
OUTPRESF?	E-17
<i>Equivalent Circuit Analysis Commands</i>	E-17
EQUCPARA?	E-17
EQUCPARS?	E-19
F. HP-IB EXECUTE Commands	
<i>Execute Command and HP-IB Command</i>	F-1
EXECUTE Specific Command	F-2
SING	F-2
<i>EXECUTE Unique Commands</i>	F-2
INPUDATTP	F-2
INPUMEMTP	F-2
OUTPDATTP?	F-2
OUTPMEMTP?	F-2
G. One-Point Correction	
<i>1 Coefficient Command</i>	G-1
HP-IB Command	G-1
INPUDATM1 real,imaginary	G-1
DATAMTHRU	G-1
<i>3-Coefficient Command</i>	G-1
HP-IB Command	G-2
INPUDATM2 real,imaginary	G-2
INPUDATM3 real,imaginary	G-2
INPUDATM4 real,imaginary	G-2
DATAM3TER	G-2
Cancel of 1-Point Correction	G-2
Sample Program	G-2
<i>Difference between 1-Point Correction and Calibration</i>	G-3

Figures

2-1. HP-IB Connections in a Typical Setup	2-2
2-2. Typical Measurement Sequence	2-3
2-3. Sample Program: Setting Up a Measurement	2-6
2-4. Sample Program: Frequency Response Calibration	2-7
2-5. Sample Program: Using Markers to Obtain Trace Data at Specific Points	2-9
2-6. Form 2 Data Transfer Format	2-11
2-7. Form 3 Data Transfer Format	2-11
2-8. Data Processing Flow	2-13
2-9. Sample Program: Data Transfer using ASCII Transfer Format (Form 4)	2-14
2-10. Sample Program: Data Transfer using IEEE 64-bit Floating Point Format (Form 3) (1/2)	2-15
2-11. Sample Program: Application Example (Bandpass Filter Test) (1/2)	2-17
2-12. Sample Program: Using List Frequency Mode (1/2)	2-19
2-13. Sample Program: Setting up Limit Lines (1/2)	2-22
2-14. Sample Program: Storing Instrument States	2-25
2-15. Reading Calibration Data (1/2)	2-27
2-16. Sample Program: Controlling Peripherals	2-30
2-17. Sample Program: Transferring Disk Data Files	2-31
2-18. Sample Program: Generating Interrupts	2-34
B-1. Status Reporting Structure	B-1
B-2. Example of Reading Status Byte (1)	B-2
B-3. Example of Reading Status Byte (2)	B-2
B-4. Example of Generating a Service ReQuest (SRQ)	B-5
C-1. Key Codes	C-1
E-1. RPLPP?	E-3
E-2. Sample Program for RPLPP	E-3
E-3. RPLHEI?	E-4
E-4. Sample Program for RPLHEI	E-4
E-5. RPLRHEI?	E-5
E-6. RPLLHEI?	E-5
E-7. RPLENV?	E-6
E-8. RPLMEA?	E-7
E-9. Sample Program for RPLRHEI, RPLLHEI, RPLENV and RPLMEA	E-7
E-10.	E-8
E-11. POLE?	E-9
E-12. Output Filter Parameters Example	E-11
E-13. Sample Program for OUTPFILT	E-12
E-14. OUTPXFIL?	E-13
E-15. OUTPCFIL?	E-14
E-16. OUTPRESO?	E-15
E-17. Sample Program for OUTPRESO	E-15
E-18. OUTPRESR?	E-16
E-19. OUTPRESF?	E-17
E-20. Four-Device Equivalent Circuit for Crystal Resonator	E-18
E-21. Admittance Characteristic Chart	E-19

Tables

<i>2-1. Units as a Function of Display Format</i>	<i>2-10</i>
<i>2-2. HP-IB Commands to Output Data Array</i>	<i>2-13</i>
<i>3-1. HP-IB Code Naming Conventions</i>	<i>3-3</i>
<i>B-1. Status Bit Definitions of the Status Byte (STB)</i>	<i>B-2</i>
<i>B-2. Status Bit Definitions of the Event Status Register (ESR)</i>	<i>B-3</i>
<i>B-3. Status Bit Definitions of the Event Status Register B (ESB)</i>	<i>B-4</i>
<i>B-4. Status Bit Definitions of the Operational Status Register (OSR)</i>	<i>B-4</i>
<i>D-1. Calibration Types and Standard Classes</i>	<i>D-1</i>
<i>D-2. Calibration Array</i>	<i>D-1</i>



Guide of HP-IB Programming Manual

This manual is a tutorial introduction to remote operation of the HP 87510A Gain Phase Analyzer using an HP 9000 series 200 or 300 computer with BASIC programming examples. The following is a brief description of each chapter and appendix.

Chapter 2 describes programming basics and provides example programs.

Chapter 3 lists HP-IB commands in alphabetic order.

Appendix A summarizes HP-IB commands according to their softkey labels.

Appendix B describes the status byte register and the other registers of the HP 87510A.

Appendix C provides the codes of the front panel keys for using the KEY HP-IB command.

Appendix D describes the calibration types and the standard classes, and the calibration coefficients.

Appendix E provides information about the waveform analysis function.

The reader should become familiar with the operation of the HP 87510A before controlling it by HP-IB. This manual is not intended to teach the BASIC programming language or to discuss HP-IB theory of operation; refer to the following documents which are better suited to these tasks.

- For more information concerning the operation of the HP 87510A, refer to the following:

HP 87510A Reference Manual

- For more information concerning BASIC, refer to the manual set for the BASIC revision being used:

BASIC Programming Techniques

BASIC Language Reference

- For more information concerning HP-IB, refer to the following:

BASIC Interfacing Techniques

Tutorial Description of the Hewlett-Packard Interface Bus

Condensed Description of the Hewlett-Packard Interface Bus



Programming Basics

This chapter describes programming basics and provides example programs.

Preparing for HP-IB Control

To run the examples in this chapter, the following equipment is required:

Required Equipment

1. HP 87510A Gain Phase Analyzer
2. HP 9000 Series 200 or 300 computer or an IBM compatible PC with a measurement co-processor or card (HP 82300 or 82324) with enough memory to hold BASIC, needed binaries (refer to "Powering Up the System"), and at least 64 kilobytes of program space.
A disk drive is required to load BASIC, if no internal disk drive is available.
3. BASIC 3.0 or higher operating system.
4. HP 10833A/B/C/D HP-IB cables to interconnect the computer, the HP 87510A, and any peripherals.

Optional Equipment

1. HP 85032B 50 Ω type-N calibration kit
2. HP 11857D Cable Kit
3. Accessory kit
4. Device under test (DUT)
5. Cables to connect DUT
6. Printer

Powering Up the System

1. Set up the HP 87510A as shown in Figure 2-1.

Connect the HP 87510A to the computer with an HP-IB cable.

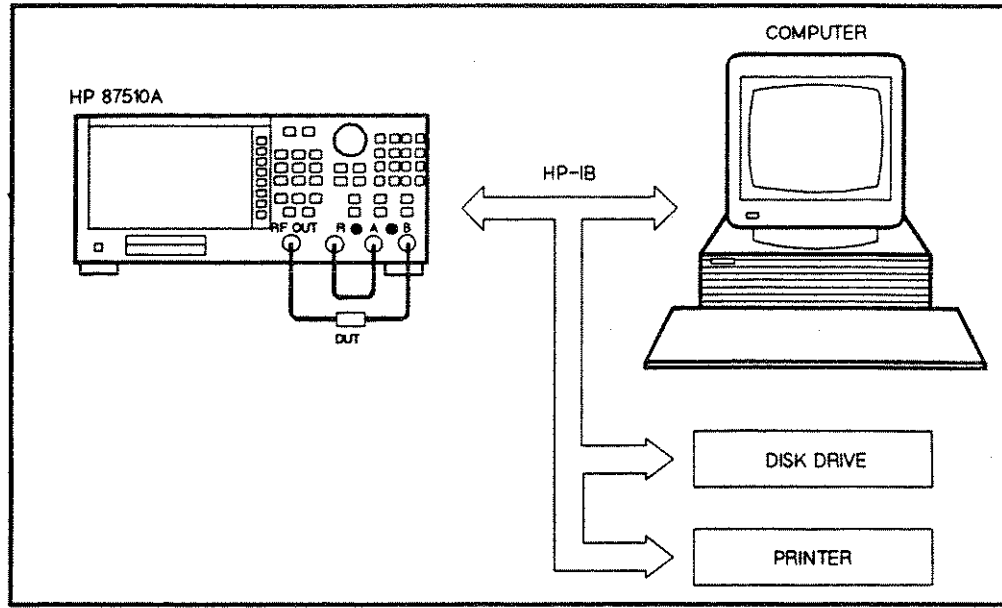

Figure 2-1. HP-IB Connections in a Typical Setup

2. Turn on the computer and load the BASIC operating system.

Load the following BASIC binary extensions:

HPIB, GRAPH, IO, KBD, and ERR.

Depending on the disk drive, a binary such as CS80 may be required.

3. Turn the HP 87510A ON.

To verify the HP 87510A's address, press **LOCAL** and select **SET ADDRESSES**

ADDRESS: 87510. If the address has been changed from the default value (17), return it to 17 while performing the examples in this document by pressing **1 7 x1**.

Make sure the HP 87510A is in the **ADDRESSABLE ONLY** mode, as indicated under the **LOCAL** key. This is the only mode in which the HP 87510A will accept HP-IB commands.

4. On the computer, type the following:

```
OUTPUT 717;"PRES" Return (or EXECUTE)
```

This will preset the HP 87510A. If preset does not occur, there is a problem. First check all HP-IB addresses and connections: most HP-IB problems are caused by an incorrect address and bad or loose HP-IB cables.

Note



Only the HP 9000 Model 226 and 236 computers have an **EXECUTE** key. The Model 216 has an **EXEC** key with the same function. All other computers use the **Return** key for both the execute and enter functions. The notation **Return** is used in this document.

Measurement Programming

This section describes how to organize the commands into a measurement sequence. Figure 2-2 shows a typical measurement sequence.

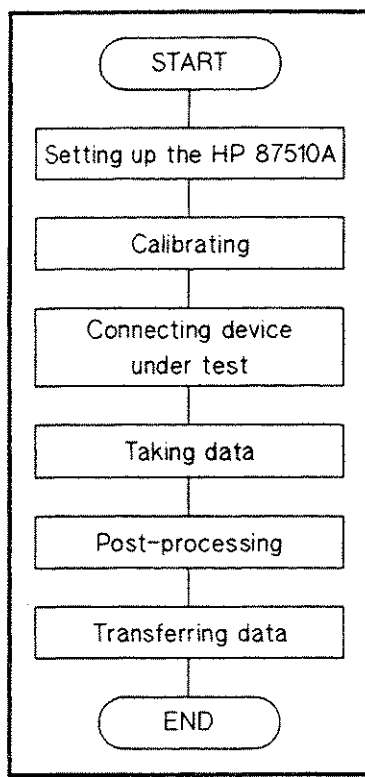

Figure 2-2. Typical Measurement Sequence

■ Setting up the HP 87510A

Define the measurement by setting all of the basic measurement parameters. These include all the stimulus parameters: sweep type, span, sweep time, number of points, and RF power level. They also include the parameter to be measured, and both IF averaging and IF bandwidth. These parameters define the way data is gathered and processed within the instrument, and to change one of these parameters requires that a new sweep be triggered.

There are other parameters that can be set within the HP 87510A that do not affect data gathering directly, such as smoothing, trace scaling or trace math. These functions are classed as post processing functions: they can be changed with the HP 87510A in the hold mode, and the data will correctly reflect the current state.

The save/recall registers provide a rapid way of setting up an entire instrument state.

■ Calibrating

Measurement calibration is normally performed once the HP 87510A state has been defined. Measurement calibration is not required to make a measurement, but it does improve measurement accuracy.

There are several ways to calibrate the HP 87510A as follows:

- The simplest is to stop the program and have the operator perform the calibration from the front panel.

- Alternatively, the computer can be used to guide the operator through the calibration, as discussed in "Frequency Response Calibration".
 - The last option is to transfer calibration data from a previous calibration back into the instrument, as discussed in "Reading Calibration Data".
- **Connecting device under test**
- Have the operator connect and adjust the device. The computer can be used to speed the adjustment process by setting up such functions such as limit testing, bandwidth searches, and trace statistics. All adjustments take place at this stage so that there is no danger of taking data from the device while it is being adjusted.
- **Taking data**
- With the device connected and adjusted, measure its frequency response, and store the data in the HP 87510A so that there is a valid trace to analyze. The single sweep command SING is designed to ensure a valid sweep. All stimulus changes are completed before the sweep is started, and the HP-IB hold state is not released until the formatted trace is displayed. When the sweep is complete, the HP 87510A is put into the hold mode, storing the data inside the HP 87510A.
- The number of groups command NUMG n is designed to work the same as single sweep, except that it triggers n sweeps. This is useful, for example, in making a measurement with an averaging factor of n. Both single sweep and number of groups restart averaging.
- **Post-processing**
- With valid data to operate on, the post-processing functions can be used. Referring ahead to Figure 2-8, any function that affects the data after the error correction stage can be used. The most useful functions are trace statistics, marker searches, and electrical delay offset.
- **Transferring data**
- Lastly, read the results out of the HP 87510A. All the data output commands are designed to ensure that the data transmitted reflects the current state of the HP 87510A:
- OUTPFORM, etc., will not transmit data until all formatting functions have been completed.
 - OUTPLIML, OUTPLIMM, and OUTPLIMF will not transmit data until the limit test has occurred, if limit testing is turned ON.
 - OUTPMARK will activate a marker if one is not already selected, and it will make sure that any current marker searches have completed before transmitting data.
 - OUTPMSTA makes sure that statistics have been calculated for the current trace before transmitting data. If statistics is not turned ON, it will turn statistics ON to update the current values, and then turn it OFF.
 - OUTPMWID makes sure that a bandwidth search has been executed for the current trace before transmitting data. If bandwidth search is not turned ON, it will turn the search ON to update the current values, and then turn it OFF.
- Data transfer is discussed further in "Data Transfer from the HP 87510A to a Computer".

Basic Programming Examples

Note



Because the sample programs are design to control the HP 87510A from external controller using HP-IB, you will have to change some statements when you use HP 87510A Instrument BASIC to control the internal gain phase function.

Change as follows:

```
"ASSIGN @Hp87510 TO 717" to "ASSIGN @Hp87510 TO 800"  
"ASSIGN @Dt TO 717;FORMAT OFF" to "ASSIGN @Dt TO 800;FORMAT OFF"  
"ABORT 7" to "ABORT 8"
```

Where 717 is an external controller's device selector (HP-IB interface code 7 and HP-IB address 17). 800 is the internal HP-IB device selector when Instrument BASIC controls the internal gain phase function.

Setting Up a Measurement

In general, the procedure for setting up measurements on the HP 87510A via HP-IB follows the same sequence as if the setup was performed manually. There is no required order, as long as the desired frequency range, number of points and power level are set prior to performing the calibration.

By interrogating the HP 87510A to determine the actual values of the start and stop frequencies, or the center frequency and frequency span, the computer can keep track of the actual frequencies.

This example illustrates how a basic measurement can be set up on the HP 87510A. The program will first select the desired parameter, the measurement format, and then the frequency range.

This example sets up a measurement of transmission(A/R) log magnitude on channel 1. When prompted for the center frequency and the frequency span, enter any value in Hz from 1.0×10^3 to 3.0×10^8 . These will be entered into the HP 87510A, and the frequencies will be displayed.

```

10      !
20      ! Setting Up a Measurement
30      !
40      ASSIGN @Hp87510 TO 717 ! If you use iBASIC, replace "717" with "800".
50      ABORT 7                ! If you use iBASIC, replace "7" to "8"
60      CLEAR @Hp87510
70      !
80      OUTPUT @Hp87510;"PRES"          ! Preset HP 87510A
90      OUTPUT @Hp87510;"CHAN1; AR; LOGM"
100     INPUT "Enter center frequency (Hz).",F_cent
110     INPUT "Enter frequency span (Hz).",F_span
120     OUTPUT @Hp87510;"CENT ";F_cent   ! Set Center frequency
130     OUTPUT @Hp87510;"SPAN ";F_span   ! Set frequency span
140     !
150     OUTPUT @Hp87510;"CENT?"
160     ENTER @Hp87510;F_cent
170     OUTPUT @Hp87510;"SPAN?"
180     ENTER @Hp87510;F_span
190     PRINT "Center frequency:",F_cent;"Hz"
200     PRINT "Frequency span:",F_span;"Hz"
210     END

```

Figure 2-3. Sample Program: Setting Up a Measurement

Line 40	Assign the HP 87510A HP-IB address. If you are using the Instrument BASIC to control the internal gain phase function, change 717 to 800
Lines 50 and 60	Prepare for HP-IB control.
Line 80	Preset the HP 87510A.
Line 90	Make channel 1 the active channel, and measure transmission parameter, A/R, display its magnitude in dB.
Lines 100 and 110	Input the center frequency and the frequency span.
Lines 120 and 130	Send the center frequency and the frequency span to the HP 87510A.
Lines 150 through 180	Query the center frequency and the frequency span.
Lines 190 and 200	Show the current center frequency and the frequency span.

Performing a THRU Calibration

This section will demonstrate how to coordinate a THRU measurement calibration by HP-IB control. The HP-IB program follows the key strokes required to calibrate from the front panel: there is a command for every step.

Frequency Response Calibration

The following program does a response calibration using a THRU calibration device. This program simplifies the calibration for the operator by giving explicit directions on the computer's display.

```

10  !
20  ! Frequency Response Calibration
30  !
40  ASSIGN @Hp87510 TO 717 ! If you use iBASIC, change "717" to "800".
50  ABORT 7                ! If you use iBASIC, change "7" to "8".
60  CLEAR 717
70  !
80  OUTPUT @Hp87510;"PRES"
90  OUTPUT @Hp87510;"CHAN1; AR; LOGM"
100 INPUT "Enter center frequency (Hz).",F_cent
110 INPUT "Enter frequency span (Hz).",F_span
120 OUTPUT @Hp87510;"CENT ";F_cent ! Set Center frequency
130 OUTPUT @Hp87510;"SPAN ";F_span ! Set Span frequency
140 !
150 OUTPUT @Hp87510;"HOLD"          ! Sweep mode is HOLD
160 OUTPUT @Hp87510;"CALKN50"       ! Select 50 ohm type-N Cal. kit
170 OUTPUT @Hp87510;"CALIRESP"     ! Select Response cal.
180 INPUT "Connect THRU, then press [Return].",Dum$ *
190 ON INTR 7 GOTO Sweep_end        ! Define branch when interrupt occurs
200 OUTPUT @Hp87510;"CLES"         ! Clear all status register
210 OUTPUT @Hp87510;"*SRE 4;ESNB 1" ! Set enable STB and ESB
220 REPEAT                          ! Wait for register is cleared
230 UNTIL SPOLL(@Hp87510)=0        ! Check STB
240 ENABLE INTR 7;2                ! Enable interrupt
250 OUTPUT @Hp87510;"STANC"        ! Measure THRU
260 Loop_top: GOTO Loop_top         ! Wait until the meas. end
270 Sweep_end: !
280 !
290 OUTPUT @Hp87510;"RESPDONE"     ! Calculating cal coefficient
300 OUTPUT @Hp87510;"*OPC?"       ! \ Wait until calculating ends
310 ENTER @Hp87510;Dum             ! /
320 OUTPUT @Hp87510;"CONT"        !
330 DISP "Response cal completed."
340 END

```

Figure 2-4. Sample Program: Frequency Response Calibration

Line 150	Set the trigger to the HOLD mode.
Line 160	Select the 50 Ω type-N calibration kit.
Line 170	Open the calibration by calling the response calibration.
Line 180	Ask for a THRU, and wait for the operator to connect it.

Line 200 through 240	Clear all status registers.
Line 250	Select and measure the THRU. There is more than one standard in this calibration, so you must identify the specific standard within this calibration. The THRU is the third softkey selection from the top in the menu, so use the STANC command to select THRU as the standard.
Lines 260 through 270	Wait for the standard to be measured. This is indicated by bit 0 (Cal std. complete) of event status register B (ESB).
Lines 290 through 310	Affirm completion of the calibration, and wait for calculation completion.
Line 320	Set the trigger to the CONTINUOUS mode.

Data Transfer from the HP 87510A to a Computer

Trace information can be read out of the HP 87510A in several ways. Data can be read off the trace selectively using the markers, or the entire trace can be read out.

Using Markers to Obtain Trace Data at Specific Points

If only specific information such as a single point off the trace or the result of a marker search is needed, the marker output command can be used to read the information.

Marker data is read out with the command OUTPMARK. This command causes the HP 87510A to transmit three numbers: marker value 1, marker value 2, and marker stimulus value. Refer to Table 2-1 for all the different possibilities for values one and two.

```

10      !
20      ! Using Markers to Obtain Trace Data at Specific Points
30      !
40      ASSIGN @Hp87510 TO 717 ! If you use iBASIC, change "717" to "800".
50      ABORT 7                ! If you use iBASIC, change "7" to "8".
60      CLEAR @Hp87510
70      !
80      OUTPUT @Hp87510;"PRES" ! Preset HP 87510A
90      OUTPUT @Hp87510;"CHAN1; AR; LOGM"
100     INPUT "Enter center frequency (Hz).",F_cent
110     INPUT "Enter frequency span (Hz).",F_span
120     OUTPUT @Hp87510;"CENT ";F_cent
130     OUTPUT @Hp87510;"SPAN ";F_span
140     !
150     ON INTR 7 GOTO Sweep_end      ! Define branch when interrupt occurs
160     OUTPUT @Hp87510;"CLES"        ! Clear status registers *
170     OUTPUT @Hp87510;"*SRE 4;ESNB 1" ! Set enable bits of STB and ESB
180     REPEAT                        ! Wait for registers are cleared
190     UNTIL SPOLL(@Hp87510)=0       ! Check STB
200     ENABLE INTR 7;2               ! Set enable interrupt
210     OUTPUT @Hp87510;"SING"        ! Sweep mode is SINGLE
220     Loop_top:GOTO Loop_top        ! Wait until sweep end
230     Sweep_end:                    !
240     !
250     OUTPUT @Hp87510;"AUTO"        ! Auto scale
260     OUTPUT @Hp87510;"MARK1"      ! Marker 1 ON
270     OUTPUT @Hp87510;"SEAMAX"     ! Search MAX
280     OUTPUT @Hp87510;"OUTPMARK?"  ! Output marker value
290     ENTER @Hp87510;Val1,Val2,Stim
300     DISP "Min val:",Val1;"dB"
310     DISP "Stim:",Stim;"Hz"
320     END

```

Figure 2-5. Sample Program: Using Markers to Obtain Trace Data at Specific Points

- Lines 150 through 230 Collect one sweep of data, and wait for completion.
- Line 250 Bring the trace data in view on the HP 87510A's display.
- Line 260 Activate marker 1.
- Line 270 Have the HP 87510A search for the trace maximum.
- Line 280 Output the marker values at that point.

Table 2-1. Units as a Function of Display Format

Display Format	Marker Mode	OUTPMARK value 1, value 2	OUTPFORM value 1, value 2	Marker Readout ¹ value, aux value
LOG MAG		dB, ²	dB, ²	dB, ²
PHASE		degrees, ²	degrees, ²	degrees, ²
DELAY		seconds, ²	seconds, ²	seconds, ²
POLAR	LIN MKR LOG MKR Re/Im	lin mag, degrees dB, degrees real, imag	real, imag real, imag real, imag	lin mag, degrees dB, degrees real, imag
LIN MAG		lin mag, ²	lin mag, ²	lin mag, ²
REAL		real, ²	real, ²	real, ²

¹ The marker readout values are the marker values displayed in the upper left hand corner of the display. They also correspond to the value and aux value associated with the fixed marker.

² Value not significant in this form, but is included in data transfers.

Trace Transfer

Getting trace data out of the HP 87510A with a 200/300 series computer can be broken down into three steps:

1. Setting up the receive array.
2. Telling the HP 87510A to transmit the data.
3. Accepting the transferred data.

Data inside the HP 87510A is always stored in pairs, to accommodate real/imaginary values, for each data point. Therefore, the receiving array has to be two elements wide, and as deep as the number of points being measured. The memory space for this array must be declared before any data is transferred from the HP 87510A to the computer.

Data Format. The HP 87510A can transmit data over HP-IB in four different formats. The type of format affects what kind of data array is declared (real or integer), since the format determines what type of data is transferred.

■ Form 2

IEEE 32-bit floating point format. In this mode, each number takes 4 bytes. This means that a 201 point transfer takes 1,608 bytes. Figure 2-6 shows the data transfer format of Form 2.

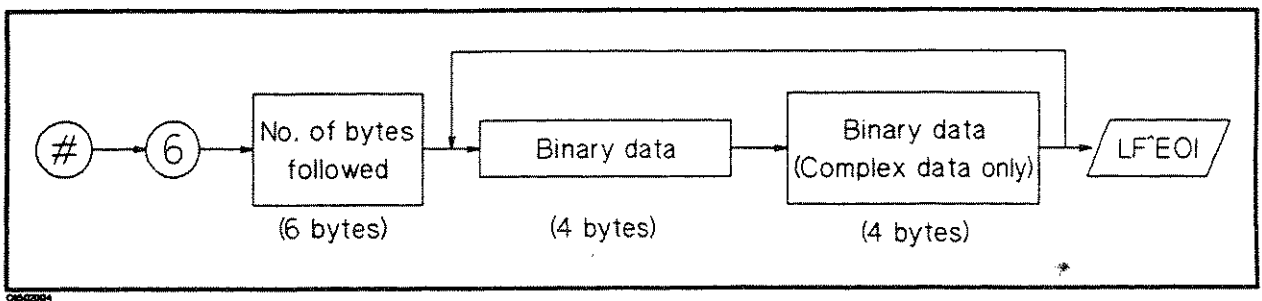

Figure 2-6. Form 2 Data Transfer Format

■ Form 3

IEEE 64-bit floating point format. In this mode, each number takes 8 bytes. This means that a 201-point transfer takes 3,216 bytes. Data is stored internally in the 200/300 series computer with the IEEE 64-bit floating point format, eliminating the need for any reformatting by the computer. Figure 2-7 shows the data transfer format of Form 3.

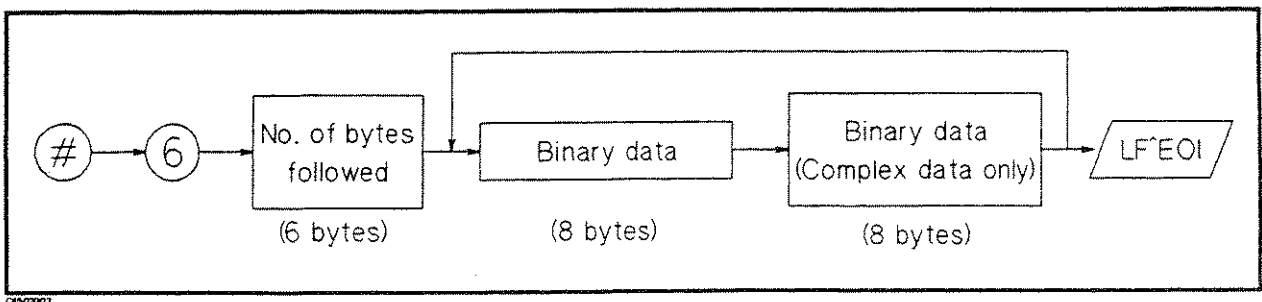

Figure 2-7. Form 3 Data Transfer Format

■ Form 4

ASCII data transfer format. In this mode, each number is sent as a 24 character string, each character being a digit, sign, or decimal point.

- Form 5

MS-DOS[®] personal computer format. This mode is a modification of IEEE 32-bit floating point format with the byte order reversed. Form 5 also has a four byte header which must be read in so that data order is maintained. In this mode, an MS-DOS[®] PC can store data internally without reformatting it.

Data Levels. HP 87510A has following data arrays in internal memory:

- Formatted data

This is the array of data being displayed. It reflects all post-processing functions such as electrical delay, and the units of the array read out depends on the current display format. Refer to Table 2-1 for various units as a function of display format. The formatted data is read out with `OUTPFORM?`, `OUTPRFORM?`, `OUTPFORMP?`, `OUTPTMEM?`, `OUTPRTMEM?`, `OUTPTMEMP?`, `OUTPIFORM?`, `OUTPIRFORM?`, `OUTPITMEM?` or `OUTPIRTMEM?`.

- Calibration coefficients

The results of a calibration are stored arrays of calibration coefficients which are used by the error correction routines. Each array corresponds to a specific error term in the error model. The calibration coefficients are read out with `OUTPCALK{01-03}?`.

Formatted data is generally the most useful, being the same information seen on the display. However, if post-processing is not necessary, as may be the case with smoothing, error corrected data is more desirable. Error corrected data also gives you the opportunity to load the data into the instrument and apply post-processing at a later time.

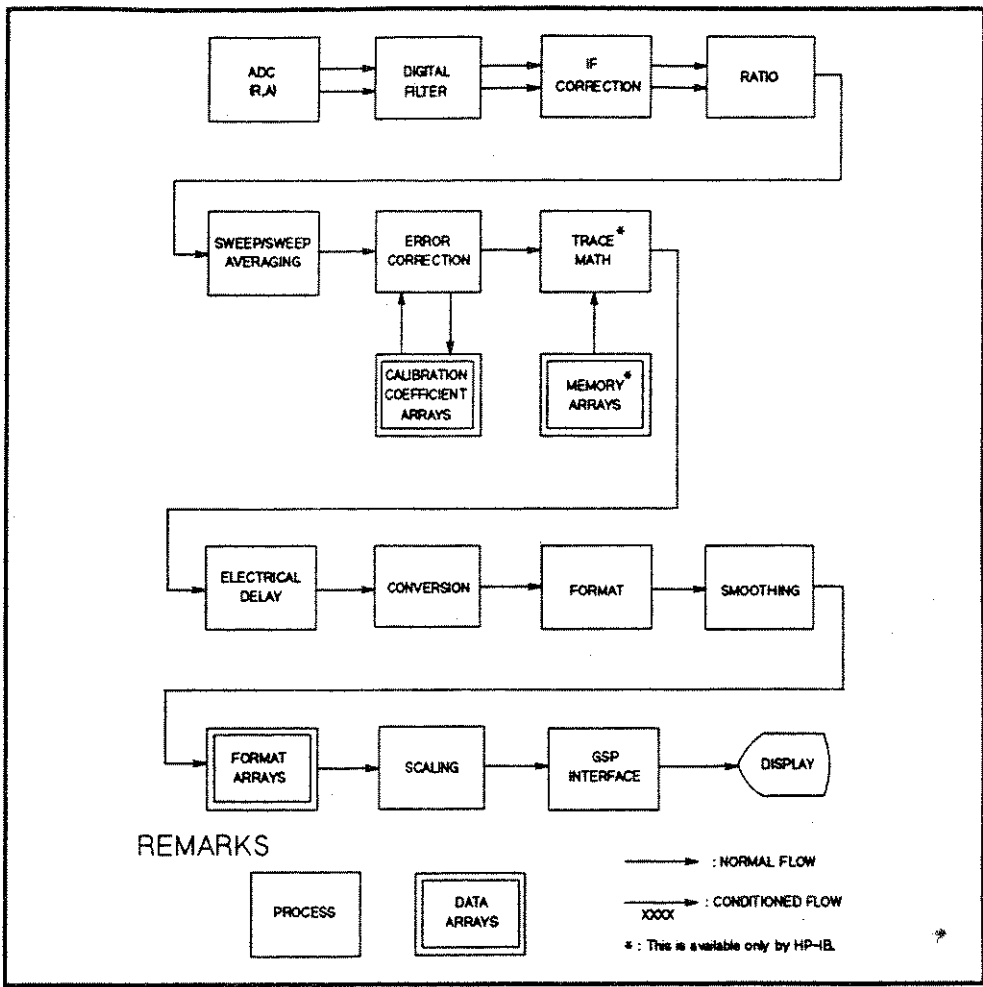

Figure 2-8. Data Processing Flow

Table 2-2. HP-IB Commands to Output Data Array

Data Output	Active Channel		Inactive Channel	
	Formatted Data		Formatted Data	
	Data Trace	Sub Trace	Data Trace	Sub Trace
Complex Data at All Points ¹	OUTPFORM?	OUTPTMEM?	OUTPPIFORM?	OUTPITMEM?
Complex Data at Specified Point ²	OUTPFORMP?	OUTPTMEMP?		
Real Data at All Point ³	OUTPRFORM?	OUTPRTMEM?	OUTPIRFORM?	OUTPIRTMEM?

1 Number of data output is two times of the Number Of Points (NOP).
 2 Number of data output is two (a real part and an imaginary part).
 3 Number of data output is equal to NOP.

Data Transfer Using ASCII Transfer Format (Form 4). When Form 4 is used, each number is sent as a 24 character string, each character being a digit, or decimal point.

```

10  !
20  ! Data Transfer Using ASCII Transfer Format
30  !
40  DIM Dat(1:201),Stim(1:201)
50  ASSIGN @Hp87510 TO 717 ! When iBASIC is used, change "717" to "800".
60  ABORT 7 ! When iBASIC is used, change "7" to "8".
70  CLEAR @Hp87510
80  !
90  OUTPUT @Hp87510;"PRES" ! Preset HP 87510A
100 OUTPUT @Hp87510;"CHAN1; AR; LOGM"
110 INPUT "Enter center frequency (Hz).",F_cent
120 INPUT "Enter frequency span (Hz).",F_span
130 OUTPUT @Hp87510;"CENT ";F_cent
140 OUTPUT @Hp87510;"SPAN ";F_span
150 !
160 ON INTR 7 GOTO Sweep_end ! Define branch when interrupt occurs
170 OUTPUT @Hp87510;"CLES" ! Clear status registers
180 OUTPUT @Hp87510;"*SRE 4;ESNB 1" ! Set enable bits of STB and ESB
190 REPEAT ! Wait for registers are cleared
200 UNTIL SPOLL(@Hp87510)=0 ! Check STB
210 ENABLE INTR 7;2 ! Set enable interrupt
220 OUTPUT @Hp87510;"SING" ! Sweep mode is SINGLE
230 Loop_top:GOTO Loop_top ! Wait until sweep end
240 Sweep_end: !
250 !
260 OUTPUT @Hp87510;"POIN?" ! Query NOP
270 ENTER @Hp87510;Nop
280 OUTPUT @Hp87510;"FORM4" ! Set ASCII Transfer Format
290 !
300 OUTPUT @Hp87510;"OUTPRFORM?" ! Real part of the formatted trace data
310 ENTER @Hp87510;Dat(*)
320 !
330 OUTPUT @Hp87510;"OUTPSTIM?" ! Stimulus data
340 ENTER @Hp87510;Stim(*)
350 !
360 FOR I=1 TO Nop
370 PRINT Stim(I);"Hz",Dat(I);"dB"
380 NEXT I
390 END

```

Figure 2-9. Sample Program: Data Transfer using ASCII Transfer Format (Form 4)

Lines 260 and 270	Find out how many points to expect.
Line 280	Tell the HP 87510A to use the ASCII transfer format.
Line 300	Request the real part of the formatted trace data.
Line 310	Transfer the data from the HP 87510A to the computer, and put it in the receiving array Dat(*).
Lines 330 and 340	Request and transfer the stimulus data.
Lines 340 through 380	Display data.

Data Transfer using IEEE 64-bit Floating Point Format (Form 3). To use Form 3, the computer is told to stop formatting the incoming data with the ENTER statement. This is done by defining an I/O path with formatting OFF. Form 3 also has an eight-byte header to deal with. The first two bytes are the ASCII characters "#6" that indicate that a fixed length block transfer follows, and the next 6 bytes form an integer containing number of bytes in the block to follow. The header must be read in so that data order is maintained.

```

10      !
20      ! Data Transfer Using IEEE 64-bit Floating Point Format
30      !
40      DIM Dat(1:201),Stim(1:201)
50      ASSIGN @Hp87510 TO 717 ! When iBASIC is used,, change "717" to "800".
60      ABORT 7                ! When iBASIC is used, change "7" to "8".
70      CLEAR @Hp87510        ! When iBASIC is used,, change "717" to "800".
80      !
90      OUTPUT @Hp87510;"PRES"          ! Preset HP 87510A
100     OUTPUT @Hp87510;"CHAN1; AR; LOGM"
110     INPUT "Enter center frequency (Hz)",F_cent
120     INPUT "Enter frequency span (Hz)",F_span
130     OUTPUT @Hp87510;"CENT ";F_cent
140     OUTPUT @Hp87510;"SPAN ";F_span
150     !
160     ON INTR 7 GOTO Sweep_end        ! Define branch when interrupt occurs
170     OUTPUT @Hp87510;"CLES"         ! Clear all status register
180     OUTPUT @Hp87510;"*SRE 4;ESNB 1" ! Set enable bits of STB and ESB
190     REPEAT                          ! Wait for registers are cleared
200     UNTIL SPOLL(@Hp87510)=0        ! Check STB
210     ENABLE INTR 7;2                ! Set enable interrupt
220     OUTPUT @Hp87510;"SING"         ! Sweep mode is SINGLE
230     Loop_top:GOTO Loop_top         ! Wait until measurement ends
240     Sweep_end:                      !
250     !
260     OUTPUT @Hp87510;"POIN?"        ! Query NOP
270     ENTER @Hp87510;Nop
280     OUTPUT @Hp87510;"FORM3"        ! IEEE 64-bit Floating Point Format
290     ASSIGN @Dt TO 717;FORMAT OFF   ! Define a data I/O path
300     !                               ! If iBASIC is used, change 717 to 800.
310     OUTPUT @Hp87510;"OUTPRFORM?"   ! Real part of formatted data trace
320     ENTER @Dt USING "#,8A";A$      ! Enter header
330     ENTER @Dt;Dat(*)               ! Enter data
340     ENTER @Dt USING "#,1A";B$      ! Enter terminator
350     !
360     OUTPUT @Hp87510;"OUTPSTIM?"    ! Stimulus data
370     ENTER @Dt USING "#,8A";A$      ! Enter header
380     ENTER @Dt;Stim(*)              ! Enter data
390     ENTER @Dt USING "#,1A";B$      ! Enter terminator
400     !

```

Figure 2-10.

Sample Program: Data Transfer using IEEE 64-bit Floating Point Format (Form 3) (1/2)

```

410  ASSIGN @Dt TO *           ! Clear I/O path
420  FOR I=1 TO Nop
430    PRINT Stim(I);"Hz",Dat(I);"dB"
440  NEXT I
450  END

```

Figure 2-10. Sample Program: Data Transfer using IEEE 64-bit Floating Point Format (Form 3) (2/2)

Line 280	Tell the HP 87510A to output data using Format 3.
Line 290	Define a data I/O path with ASCII formatting OFF. The I/O path points to the HP 87510A, and can be used to read or write data to the HP 87510A, as long as that data is in binary rather than ASCII format.
Line 320	Enter the header.
Line 330	Enter the data.
Line 340	Enter the terminator.
Line 420 through 440	Display data.

Application Example

The following example measures the transmission parameter of a bandpass filter and obtains the typical parameters: -3 dB bandwidth, Center frequency, and Insertion loss.

```
10      !
20      ! Bandpass Filter Test
30      !
40      ASSIGN @Hp87510 TO 800 ! When iBASIC is used, change "717" to "800".
50      ABORT 7                ! When iBASIC is used, change "7" to "8".
60      CLEAR @Hp87510
70      !
80      OUTPUT @Hp87510;"PRES" ! Preset HP 87510A
90      OUTPUT @Hp87510;"CHAN1; AR; LOGM" ! Set up measurement parameters
100     INPUT "Enter center frequency (Hz).",F_cent
110     INPUT "Enter frequency span (Hz).",F_span
120     OUTPUT @Hp87510;"CENT ";F_cent
130     OUTPUT @Hp87510;"SPAN ";F_span
140     !
150     OUTPUT @Hp87510;"HOLD"      ! Perform cal measurement
160     OUTPUT @Hp87510;"CALKN50"
170     OUTPUT @Hp87510;"CALIRESP"
180     INPUT "Connect THRU, then press [Return].",Dum$
190     !
200     Command$="STANC"
210     GOSUB Pre_end
220     OUTPUT @Hp87510;"RESPDONE"
230     INPUT "Cal completed. Connect DUT, then press [Return].",Dum$
240     !
250     Command$="SING"             ! Trigger a sweep
260     GOSUB Pre_end              ! Wait until sweep ends
270     !
280     OUTPUT @Hp87510;"MARK1"    ! Marker 1 ON
290     OUTPUT @Hp87510;"SEAMAX"   ! Search MAX.
300     OUTPUT @Hp87510;"OUTPMARK?" ! Query marker value
310     ENTER @Hp87510;Loss
320     !
330     OUTPUT @Hp87510;"DELR1"    ! Select MKR1 as delta ref. marker
340     OUTPUT @Hp87510;"WIDV -3"  ! Width value is -3
350     OUTPUT @Hp87510;"WIDTON"   ! Width ON
360     OUTPUT @Hp87510;"OUTPMWID?" ! Query width parameters
370     ENTER @Hp87510;Bw,Cent,Q
380     !
```

Figure 2-11. Sample Program: Application Example (Bandpass Filter Test) (1/2)

```

390 PRINT "-3dB bandwidth= ",Bw;"Hz"
400 PRINT "Center frequency= ",Cent;"Hz"
410 PRINT "Insertion loss= ",Loss;"dB"
420 STOP
430 !
440 Pre_end: !
450 IN INTR 7 GOTO Sweep_end
460 OUTPUT @Hp87510;"CLES"
470 OUTPUT @Hp87510;"*SRE 4;ESNB 1"
480 REPEAT
490 UNTIL SPOLL(@Hp87510)=0
500 ENABLE INTR 7;2
510 OUTPUT @Hp87510;Command$
520 Loop_top:GOTO Loop_top
530 Sweep_end:
540 RETURN
550 END

```

Figure 2-11. Sample Program: Application Example (Bandpass Filter Test) (2/2)

Lines 80 through 130	Set up measurement.
Lines 150 through 230	Do a response calibration.
Lines 250 through 260	Collect one sweep of data.
Lines 280 through 310	Get the insertion loss value using the marker search function.
Lines 330 through 370	Take the -3 dB bandwidth value and the center frequency value using the bandwidth search function.

Advanced Programming Examples

Using List Frequency Mode

The list frequency mode lets you select the specific points or frequency spacing between points at which measurements are to be made. Sampling specific points reduces the measurement time since additional time is not spent measuring device characteristics at unnecessary frequencies.

This example shows how to create a list frequency table and send it to the HP 87510A. The command sequence for entering a list frequency table imitates the key sequence followed when entering a table from the front panel: there is a command for every key press. Editing a segment is also the same as the key sequence, but the HP 87510A automatically reorders each edited segment in order of increasing start frequency.

This example takes advantage of the computer's capabilities to simplify creating and editing the table. The table is entered and completely edited before being transmitted to the HP 87510A. To simplify the programming task, options such as entering step size are not included.

```
10      !
20      ! Using List Frequency Mode
30      !
40      DIM Table(1:31,1:3)
50      ASSIGN @Hp87510 TO 717 ! When iBASIC is used, change "717" to "800".
60      ABORT 7                ! When iBASIC is used, change "7" to "8".
70      CLEAR @Hp87510
80      !
90      INPUT "Number of segments?",Numb
100     !
110     PRINTER IS CRT
120     CLEAR SCREEN
130     PRINT USING "10A,10A,10A,20A";"Segment","Start(Hz)","Stop(Hz)"
        ,"Number of points"
140     !
150     FOR I=1 TO Numb
160         GOSUB Loadpoin
170     NEXT I
180     !
190     LOOP
200     INPUT "Do you want to edit? (Y/N)",An$
210     EXIT IF An$="N" OR An$="n"
220     INPUT "Segment Number?",I
230     GOSUB Loadpoin
240     END LOOP
250     !
```

Figure 2-12. Sample Program: Using List Frequency Mode (1/2)

```

260 OUTPUT @Hp87510;"PRES"           ! Preset HP 87510A
270 OUTPUT @Hp87510;"CHAN1; AR; LOGM"
280 !
290 OUTPUT @Hp87510;"EDITLIST"       ! Freq. List Edit mode
300 OUTPUT @Hp87510;"CLEL"           ! Clear list
310 FOR I=1 TO Numb
320   OUTPUT @Hp87510;"SADD"          ! Add new segment
330   OUTPUT @Hp87510;"STAR ";Table(I,1) ! Start freq. of segment
340   OUTPUT @Hp87510;"STOP ";Table(I,2) ! Stop freq. of segment
350   OUTPUT @Hp87510;"POIN ";Table(I,3) ! Number of points
360   OUTPUT @Hp87510;"SDON"          ! Complete editing segment
370 NEXT I
380 OUTPUT @Hp87510;"EDITDONE"       ! Complete editing list
390 OUTPUT @Hp87510;"LISFREQ"        ! List freq. mode ON
400 OUTPUT @Hp87510;"LISDOBASE"      ! List Display Order Base
410 !
420 ON INTR 7 GOTO Sweep_end          ! Define branch when interrupt occurs
430 OUTPUT @Hp87510;"CLES"           ! Clear all status registers
440 OUTPUT @Hp87510;"*SRE 4;ESNB 1" ! Set enable bits of STB and ESB
450 REPEAT                             ! Wait for registers are cleared
460 UNTIL SPOLL(@Hp87510)=0           ! Check STB
470 ENABLE INTR 7;2
480 OUTPUT @Hp87510;"SING"           ! Trigger a sweep
490 Loop_top:GOTO Loop_top
500 Sweep_end:                          !
510 !
520 OUTPUT @Hp87510;"AUTO"           ! Auto scale
530 STOP
540 !
550 Loadpoin: !
560 INPUT "Enter start frequency (Hz)",Table(I,1)
570 INPUT "Enter stop frequency (Hz)",Table(I,2)
580 INPUT "Enter number of points",Table(I,3)
590 IF Table(I,3)=1 THEN Table(I,2)=Table(I,1)
600 PRINT TABXY(0,I+1);I;TAB(10);Table(I,1);TAB(20);Table(I,2);TAB(35)
    ;Table(I,3)
610 RETURN
620 END

```

Figure 2-12. Sample Program: Using List Frequency Mode (2/2)

Line 90	Find out how many segments to expect.
Lines 120 through 140	Clear the screen and print the table header.
Lines 160 through 180	Read in each segment.
Lines 200 through 250	Edit the table until editing is no longer needed.
Line 300	Activate the frequency list edit mode, and open the list frequency table for editing.
Line 310	Delete any existing segments.
Lines 320 through 380	Enter the segment values.
Line 390	Close the table.
Line 400	Turn on the list frequency mode.
Line 410	Display the trace for only the listed frequency ranges.
Lines 550 through 600	This is a segment input routine.

Line 590

Set the stop frequency equal to the start frequency to avoid ambiguity, if only one point is in the segment.

Using Limit Lines to Perform Limit Testing

This example shows how to create a limit table and send it to the HP 87510A. The command sequence for entering a limit table imitates the key sequence followed when entering a table from the front panel: there is a command for every key press. Editing a limit is also the same as the key sequence, but remember that the HP 87510A automatically reorders the table in order of increasing start frequency.

This example takes advantage of the computer's capabilities to simplify creating and editing the table. The table is entered and completely edited before being transmitted to the HP 87510A. To simplify the programming task, options such as entering offsets are not included.

```
10      !
20      ! Setting Up Limit Lines
30      !
40      DIM Table(1:31,1:3)
50      ASSIGN @Hp87510 TO 717 ! When iBASIC is used, change "717" to "800".
60      ABORT 7                ! When iBASIC is used, change "7" to "8".
70      CLEAR @Hp87510
80      !
90      OUTPUT @Hp87510;"PRES"  ! Preset HP 87510A
100     OUTPUT @Hp87510;"CHAN1; AR; LOGM"
110     OUTPUT @Hp87510;"SING"  ! Sweep mode is SINGLE
120     INPUT "Enter start frequency (Hz)",F_start
130     INPUT "Enter stop frequency (Hz)",F_stop
140     OUTPUT @Hp87510;"STAR ";F_start
150     OUTPUT @Hp87510;"STOP ";F_stop
160     !
170     INPUT "Number of limits?",Numb
180     !
190     PRINTER IS 1
200     CLEAR SCREEN
210     PRINT USING "10A,15A,15A,15A";"Segment","Stimulus(Hz)","Upper(dB)"
        ,"Lower(dB)"
220     !
230     FOR I=1 TO Numb
240         GOSUB Loadlimit
250     NEXT I
260     !
270     LOOP
280         INPUT "Do you want to edit? (Y/N)",An$
290     EXIT IF An$="N" OR An$="n"
300         INPUT "Segment Number?",I
310         GOSUB Loadlimit
320     END LOOP
330     !
```

Figure 2-13. Sample Program: Setting up Limit Lines (1/2)

```

340  OUTPUT @Hp87510;"EDITLIML"      ! Edit limit line table
350  OUTPUT @Hp87510;"LIMCLEL"      ! Delete limit table
360  FOR I=1 TO Numb
370      OUTPUT @Hp87510;"LIMSADD"      ! Add segment
380      OUTPUT @Hp87510;"LIMS ";Table(I,1) ! Stimulus break point
390      OUTPUT @Hp87510;"LIMU ";Table(I,2) ! Upper limit value
400      OUTPUT @Hp87510;"LIML ";Table(I,3) ! Lower limit value
410      OUTPUT @Hp87510;"LIMSDON"      ! Complete editing segment
420  NEXT I
430  !
440  OUTPUT @Hp87510;"LIMEDONE"      ! Complete editing limit table
450  OUTPUT @Hp87510;"LIMILINEON"    ! Display limit line
460  OUTPUT @Hp87510;"LIMITESTON"    ! Limit test ON
470  ON INTR 7 GOTO Sweep_end        ! Define branch when interrupt occurs
480  OUTPUT @Hp87510;"CLES"          ! Clear all status register
490  OUTPUT @Hp87510;"*SRE 4;ESNB 1" ! Set enable bits of STB and ESB
500  REPEAT                          ! Wait for registers are cleared
510  UNTIL SPOLL(@Hp87510)=0        ! Check STB
520  ENABLE INTR 7;2                ! Set enable interrupt
530  OUTPUT @Hp87510;"SING"          ! Trigger a sweep
540  Loop_top: GOTO Loop_top
550  Sweep_end:                      !
560  !
570  OUTPUT @Hp87510;"OUTPFAIP?"    ! Ask number of failed points
580  ENTER @Hp87510;Result          ! Enter number of failed points
590  IF Result=0 THEN
600      PRINT "PASS"
610  ELSE
620      PRINT "FAIL"
630  END IF
640  STOP
650  !
660  Loadlimit:                      !
670  INPUT "Enter stimulus value (Hz)",Table(I,1)
680  INPUT "Enter upper limit value (dB)",Table(I,2)
690  INPUT "Enter lower limit value (dB)",Table(I,3)
700  PRINT TABXY(0,I+1);I;TAB(11);Table(I,1);TAB(27);Table(I,2);TAB(42)
      ;Table(I,3)
710  RETURN
720  END

```

Figure 2-13. Sample Program: Setting up Limit Lines (2/2)

Line 40	Create a table to hold the limit values. It will contain the stimulus value (frequency), the upper limit value, and the lower limit value.
Line 170	Ask for number of limits to expect.
Lines 190 through 210	Clear the screen and print the table header.
Lines 230 through 250	Read in each segment.
Lines 270 through 320	Edit the table until editing is no longer needed.
Line 340	Begin editing the limit line table.
Line 350	Delete any existing limits.
Lines 360 through 420	Enter the segment values.
Line 440	Close the table.

Line 450	Display the limits.
Line 460	Activate the limit testing.
Lines 570 through 640	Detect result of the test and display PASS or FAIL.

Storing and Recalling Instrument States

This example demonstrates ways of storing and recalling entire instrument states using HP-IB.

Coordinating disk storage

This example shows how to save and recall the instrument STATES from the disk installed in the built-in disk drive.

```

10  !
20  ! Storing Instrument States
30  !
40  DIM Err$(50)
50  ASSIGN @Hp87510 TO 717 ! When iBASIC is used, replace "717" with "800".
60  ABORT 7                ! When iBASIC is used, replace "7" to "8".
70  CLEAR @Hp87510
80  OUTPUT @Hp87510;"*CLS"
90  OUTPUT @Hp87510;"PRES" ! Preset HP 87510A
100 OUTPUT @Hp87510;"CHAN1; AR; LOGM"
110 INPUT "Enter center frequency (Hz).",F_cent
120 INPUT "Enter frequency span (Hz).",F_span
130 OUTPUT @Hp87510;"CENT ";F_cent
140 OUTPUT @Hp87510;"SPAN ";F_span
150 !
160 INPUT "File name? (up to 8 char.)",Name$
170 OUTPUT @Hp87510;"STODDISK"          ! Storage device is DISK
180 OUTPUT @Hp87510;"SAVDSTA """;Name$,""""" ! Save Instrument states
190 OUTPUT @Hp87510;"*OPC?"
200 ENTER @Hp87510;Dum
210 OUTPUT @Hp87510;"OUTPERRO?"
220 ENTER @Hp87510;Err,Err$
230 IF Err THEN
240     PRINT "Error occurred."
250     PRINT Err$
260     STOP
270 ELSE
280     INPUT "Save done. Press [Return] to recall.",Dum$
290 END IF
300 !
310 OUTPUT @Hp87510;"PRES"
320 OUTPUT @Hp87510;"RECD """;Name$;"_S"""" ! Recall instrument state
330     ! If DOS format disk is used, replace "_S" with ".STA".
340 OUTPUT @Hp87510;"*OPC?"
350 ENTER @Hp87510;Dum
360 DISP "Done."
370 END

```

Figure 2-14. Sample Program: Storing Instrument States

Line 160	Get the name of the file to be created.
Line 170	Select an internal flexible disk drive for storage device.
Line 180	Save the instrument states and the calibration coefficients with the file name. The file name must be preceded and followed by double

	quotation marks, and the only way to do that with an OUTPUT statement is to use two sets of quotation marks: "".
Lines 190 and 200	Wait for completion of the save operation.
Lines 210 and 220	Check whether or not an error occurred.
Lines 230 through 290	If an error is detected, print the error number and the error message. If an error is not detected, prompt the user to continue the program.
Line 320	Add the extension to the file name and recall the file.

Reading Calibration Data

This example demonstrates how to read measurement calibration data out of the HP 87510A, and how to return the data to the HP 87510A.

The data used to perform measurement error correction is stored inside the HP 87510A in up to three calibration coefficient arrays. Each array stores a specific error coefficient, and is stored and transmitted as an error corrected data array: each point is a real/imaginary pair, and the number of points in the array is the same as the number of points in the sweep. The four data formats also apply to the transfer of calibration coefficient arrays. Appendix D specifies where the calibration coefficients are stored for different calibration types.

A computer can read out the error coefficients using the OUTPCALC{01-03} commands. Each calibration type uses only as many arrays as needed, starting with array 1. Therefore, it is necessary to know the type of calibration about to be read out: attempting to read an array not being used in the current calibration causes the "REQUESTED DATA NOT CURRENTLY AVAILABLE" warning to be displayed.

A computer can also store calibration coefficients in the HP 87510A. To do this, declare the type of calibration data about to be stored in the HP 87510A just as if you were about to perform that calibration. Then, instead of calling up different classes, transfer the calibration coefficients using the INPUCALC{01-03} commands. When all the coefficients are in the HP 87510A, activate the calibration by issuing the command SAVC, to have the HP 87510A take a sweep measurement.

This example reads the response calibration coefficients into a very large array, from which they can be examined, modified, stored, or returned to the HP 87510A.

```

10  !
20  ! Reading Calibration Data
30  !
40  DIM Dat(1:201,1:2)
50  DIM Head$(6)
60  ASSIGN @Hp87510 TO 717 ! When iBASIC is used, replace "717" to "800".
70  ABORT 7 ! When iBASIC is used, replace "7" to "8".
80  CLEAR @Hp87510
90  !
100 INPUT "Connect THRU and press [Return] to do cal.",Dum$
110 GOSUB Setup
120 GOSUB Cal
130 OUTPUT @Hp87510;"SAVC" ! Re-draw trace
140 OUTPUT @Hp87510;"POIN?" ! Ask Number of points
150 ENTER @Hp87510;Nop ! Enter NOP
170 !
180 INPUT "Press [Return] to transmit cal data.",Dum$
190 ASSIGN @Dt TO 717;FORMAT OFF ! Set data I/O path
200 OUTPUT @Hp87510;"FORM3" ! IEEE 64-bit Floating Point Format
210 OUTPUT @Hp87510;"OUTPCALC01?" ! Query calibration array
220 ENTER @Dt USING "#,8A";A$ ! Enter header
230 ENTER @Dt;Dat(*) ! Enter data
240 ENTER @Dt USING "#,1A";B$ ! Enter terminator
250 INPUT "Transmit done. Disconnect THRU and press [Return].",Dum$
260 !
270 GOSUB Setup
280 GOSUB Cal
290 OUTPUT @Hp87510;"SAVC" ! Re-draw trace
300 !
310 INPUT "Press [Return] to retransmit cal data.",Dum$
320 V$=VAL$(Nop*2*8)
330 Numv=LEN(V$)
340 Head$="000000" ! Initialize header value
350 FOR I=1 TO Numv
360 Head$[7-I,7-I]=V$[Numv-I+1,Numv-I+1]
370 NEXT I
380 !
390 OUTPUT @Hp87510;"INPUCALC01 "; ! Store cal data by HP-IB
400 OUTPUT @Dt USING "#,8A";"#6"&Head$ ! Send header
410 OUTPUT @Dt;Dat(*),END ! Send data
420 OUTPUT @Hp87510;"SAVC" ! Re-draw trace
430 !
440 ASSIGN @Dt TO * ! Clear I/O path
460 DISP "Retransmit completed. Connect DUT."
470 OUTPUT @Hp87510;"CONT" ! Sweep mode is CONT
480 STOP
490 !

```

Figure 2-15. Reading Calibration Data (1/2)

```

500 Setup: !
510 F_cent=7.E+7
520 F_span=200000.
530 OUTPUT @Hp87510;"PRES;"
540 OUTPUT @Hp87510;"CHAN1; AR; LOGM"
550 OUTPUT @Hp87510;"CENT ";F_cent
560 OUTPUT @Hp87510;"SPAN ";F_span
570 OUTPUT @Hp87510;"SING"
580 RETURN
590 !
600 Cal: !
610 OUTPUT @Hp87510;"swet 4"
620 OUTPUT @Hp87510;"CALIRESP"
630 ON INTR 7 GOTO Sweep_end
640 OUTPUT @Hp87510;"CLES"
650 OUTPUT @Hp87510;"*SRE 4;ESNB 1"
660 REPEAT
670 UNTIL SPOLL(@Hp87510)=0
680 ENABLE INTR 7;2
690 OUTPUT @Hp87510;"STANC"
700 Loop_top:GOTO Loop_top
710 Sweep_end: !
720 !
730 OUTPUT @Hp87510;"*0PC?"
740 ENTER @Hp87510;Dum
750 OUTPUT @Hp87510;"RESPDONE"
760 RETURN
770 END

```

Figure 2-15. Reading Calibration Data (2/2)

Line 50	Declare the dimension part of the file header.
Line 110	Preset and set up the HP 87510A, and hold the trigger.
Line 120	Perform a response calibration.
Line 130	Re-draw the trace with the calibration data.
Line 210	Request outputting the calibration data.
Line 220	Enter the file header.
Line 230	Enter the calibration data.
Line 240	Enter the file terminator.
Line 280	Perform the calibration to set the correction ON.
Line 320	Calculate the number of bytes transferred, and represents it in the string format.
Line 330	Count the number of characters in the string which contains the number of bytes transferred.
Line 340	Enter 0 as the initial value in all header arrays.
Line 350 through 370	Place the number of bytes transferred to the header array digit by digit from the sixth array to the first array of the header.
Line 390 through 410	Send the file header and calibration data.

Miscellaneous Programming Examples

Controlling Peripherals

The purpose of this section is to demonstrate how to coordinate printers or plotters with the HP 87510A.

The HP 87510A has two operating modes with respect to HP-IB, as set under the **LOCAL** menu: System controller mode and Addressable only mode. The system controller mode is used when no controller is present. The addressable only mode is how a computer can control the HP 87510A and passes active control to the HP 87510A so that the HP 87510A can plot or print.

Note that the HP 87510A assumes that the address of the computer is correctly stored in its HP-IB addresses menu under the **ADDRESS: CONTROLLER** entry. If this address is incorrect, control will not return to the computer.

If the HP 87510A is in Addressable only mode and receives a command telling it to plot or print, it sets bit 1 in the event status register to indicate that it needs control of the bus. If the computer then uses the HP-IB control command to pass control to the HP 87510A, the HP 87510A will take control of the bus, and access the peripheral. When the HP 87510A no longer needs control, it will pass it back to the computer.

Control should not be passed to the HP 87510A before it has set event status register bit 1, Request Active Control. If the HP 87510A receives control before the bit is set, control is passed immediately back.

While the HP 87510A has control, it is free to address devices to talk and listen as needed. The only functions denied it are the ability to assert the interface clear line (IFC), and remote line (REN). These are reserved for the system controller. As active controller, the HP 87510A can send messages to and read replies back from printers and plotters.

This example prints the display.

```

10      !
20      ! Controlling Peripherals
30      !
40      DIM Err$(100)
50      ASSIGN @Hp87510 TO 717
60      !
70      OUTPUT @Hp87510;"*CLS"      ! Clear status reporting system
80      OUTPUT @Hp87510;"*ESE 2" ! Enable Request Active Control bit of ESE
90      !
100     OUTPUT @Hp87510;"PRINALL"
110     REPEAT
120         Stat=SPOLL(@Hp87510)
130     UNTIL BIT(Stat,5)
140     !
150     PASS CONTROL @Hp87510      ! Pass active control to HP 87510
160     DISP "Printing."
170     REPEAT
180         STATUS 7,6;Hpib
190     UNTIL BIT(Hpib,6)
200     DISP "Done."
205     ABORT 7                      ! Return active control to system controller
210     !
220     OUTPUT @Hp87510;"OUTPERRO?"
230     ENTER @Hp87510;Err,Err$
240     IF Err THEN DISP Err$
250     END

```

Figure 2-16. Sample Program: Controlling Peripherals *

Line 70	Clear the status reporting system.
Line 80	Enable the Request Active Control bit in the event status register.
Line 100	Request printing.
Lines 110 through 130	Wait until the HP 87510A requests control.
Line 150	Pass active control to the HP 87510A.
Line 170 through 190	Wait until the print is finished and control is returned.
Line 205	Return active control to the system controller.
Line 220 through 240	If an error occurred, print the error number and the error message.

Transferring disk data files

The built-in disk drive is often used to store data files in addition to instrument states. The file name is then appended with two characters to indicate what is in the file. "_D" indicates the file contains the internal data array using the **SAVE DATA ONLY** or the SAVDDAT command. Refer to "Saving and Recalling Instrument States and Data" in the *Reference Manual* for the file structure.

This example demonstrates how to recall a data file stored by the built-in disk drive into a computer using the disk drive connected to the computer.

Before running the program, store the data to the disk installed in the built-in disk drive, remove the disk, and put the disk in to the computer's disk drive.

```

10      !
20      ! Transferring Disk Data Files
30      !
50      INTEGER Nop
60      DIM Sw$(1:7)[8],Numseg(1:7)
70      DATA "Raw",8,"Cal",24,"Data",2,"Mem",2,"Uniform",2,"Trace",2
      , "Tracemem",2
80      !
90      INPUT "File name (with extension)?",File$
100     ASSIGN @Path TO File$
110     ENTER @Path USING "6X,#"
120     Numdat=0
130     PRINT "Data contained:"
140     FOR I=1 TO 7
150         READ Dat$,Num
160         GOSUB Datasw
170     NEXT I
180     PRINT
190     ENTER @Path USING "4X,#"
200     !
210     INPUT "Press [Return] to read data.",Dum$
220     FOR J=1 TO Numdat
230         FOR I=1 TO Numseg(J)
240             PRINT Sw$(J);I
250             GOSUB Dataseg
260             PRINT
270         NEXT I
280         PRINT
290         IF JNumdat THEN INPUT "Press [Return] to read next data.",Dum$
300     NEXT J
310     ASSIGN @Path TO *
320     STOP
330     !

```

Figure 2-17. Sample Program: Transferring Disk Data Files

```

340 Dataseg: !
350 ENTER @Path;Nop
360 ENTER @Path USING "4X,#"
370 FOR K=1 TO Nop
380     ENTER @Path;X,Y
390     PRINT K,X,Y
400 NEXT K
410 ENTER @Path USING "4X,#"
420 RETURN
430 !
440 Datasw: !
450 ENTER @Path USING "B,#";Sw
460 IF Sw THEN
470     Numdat=Numdat+1
480     Sw$(Numdat)=Dat$
490     Numseg(Numdat)=Num
500     PRINT Sw$(Numdat)
510 END IF
520 RETURN
530 END

```

Figure 2-17. Sample Program: Transferring Disk Data Files (2/2)

Lines 50 and 60	Set up the data of possible data groups.
Line 90	Get the file name to load. The file name must be included the extension: "_D"(for LIF) or .DAT(for DOS).
Line 100	Define an I/O path which points to the chosen file.
Line 120 through 170	Read the data switches and examine the data contained.
Line 220 through 300	Enter a data group.
Line 230 through 270	Enter a data segment.
Line 310	Close the I/O path.
Lines 340 through 420	Read a data switch.
Lines 440 through 510	Enter a data segment.

Status Reporting

The HP 87510A has a status reporting mechanism that gives information about specific functions and events inside the HP 87510A. The status byte is an 8-bit register with each bit summarizing the state of one aspect of the HP 87510A. For example, the error queue summary bit will always be set if there are any errors in the queue. The value of the status byte can be read with the SPOLL statement. This command does not automatically put the HP 87510A into the remote mode, thus giving the operator access to the HP 87510A front panel functions. Reading the status byte does not affect its value. The sequencing bit can be set by the operator during execution of a test sequence.

The status byte also summarizes two event status registers and one operational status register that monitor specific conditions inside the HP 87510A. The status byte also has a bit that is set when the HP 87510A is issuing a service request over HP-IB, and a bit that is set when the HP 87510A has data to send out over HP-IB. Refer to Appendix B for a definition of the status registers.

The error queue holds up to 20 instrument errors and warnings in the order that they occurred. Each time the HP 87510A detects an error condition and displays a message on the CRT, it also puts the error in the error queue. If there are any errors in the queue, bit 3 of the status byte will be set. The errors can be read from the queue with the OUTPERR? command, which causes the HP 87510A to transmit the error number and the error message of the oldest error in the error queue (first in first out).

It is also possible to generate interrupts using the status reporting mechanism. The status byte bits can be enabled to generate a service request (SRQ) when set. The computer can in turn be set up to generate an interrupt on SRQ.

To be able to generate an SRQ, a bit in the status byte has to be enabled using *SRE *n*. A one in a bit position enables that bit in the status byte. Therefore, *SRE 8 enables an SRQ on bit 3, check error queue, since 8 equals 0000 1000 in binary representation. That means that whenever an error is put into the error queue and bit 3 is set, and the SRQ line is asserted. The only way to clear the SRQ is to disable bit 3, re-enable bit 3, or read out all the errors from the queue.

A bit in the event status register can be enabled so that it is summarized by bit 5 of the status byte. If any bit is enabled in the event status register, bit 5 of the status byte will also be set. For example, *ESE 66 enables bits 1 and 6 of the event status register, since 66 equals 0100 0010 in binary representation. Therefore, whenever active control is requested or a front panel key is pressed, bit 5 of the status byte will be set. Similarly, ESNB *n* enables bits in event status register B so that they will be summarized by bit 2 in the status byte.

To generate an SRQ from an event status register, enable the desired event status register bit. Then enable the status byte to generate an SRQ. For instance, *ESE 32 and *SRE 32 enable the syntax error bit, so that when the syntax error bit is set, the summary bit in the status byte will be set, and it enables an SRQ on bit 5 of the status byte.

During the sample program (Figure 2-18) is running, you can try get into the subroutine "Err_report:" when this program is executed in an external controller and Instrument BASIC is installed in your HP 87510A.

Type a command in command line on the HP 87510A from the keyboard to occur an error:

For example :

```
OUTPUT 800;"HELLO"
```

Because HELLO is not the command of HP 87510A, an error will occur.

```

10      !
20      ! Generating Interrupts
30      !
40      ASSIGN @Hp87510 TO 717
50      !
60      OUTPUT @Hp87510;"*CLS"      ! Clear status reporting system
70      OUTPUT @Hp87510;"*ESE 32"  ! Enable bit-5 of ESR
80      OUTPUT @Hp87510;"*SRE 32"  ! Enable bit-5 or status byte
90      !
100     ON INTR 7 GOSUB Err_report
110     ENABLE INTR 7;2
120     !
130     LOOP
140     END LOOP
150     STOP
160     !
170     Err_report: !
180     Stat=SPOLL(@Hp87510)
190     OUTPUT @Hp87510;"*ESR?"
200     ENTER @Hp87510;Estat
210     PRINT "Syntax error detected."
220     !
230     OUTPUT @Hp87510;"OUTPERRO?" ! Ask error
240     ENTER @Hp87510;Err,Err$      ! Enter error number and message
250     PRINT Err,Err$
260     !
270     ENABLE INTR 7
280     RETURN
290     END

```

Figure 2-18. Sample Program: Generating Interrupts

Line 60	Clear the status reporting system.
Line 70	Enable bit 5 of the event status register.
Line 80	Enable bit 5 of the status byte so that an SRQ will generated when a syntax error occurs.
Line 100	Tell the computer where to branch on an interrupt.
Line 110	Tell the computer to enable an interrupt from interface 7 (HP-IB) when value 2 (bit 1: SRQ bit) of the interrupt register is set. A branch to Err_report will disable the interrupt, so the return from Err_report re-enables it. If there is more than one instrument on the bus capable of generating an SRQ, it is necessary to use serial poll to determine which device has issued the SRQ. In this case, we assume the HP 87510A issued it. A branch to Err_report will disable the interrupt, so the return from Err_report re-enable it.
Line 130 and 140	Do nothing loop.
Line 180	Clear the SRQ bit of the status byte.
Lines 190 and 200	Read the register to clear the bit.
Lines 230 through 250	Instruct the HP 87510A to output the error number and the error message, and print them.

HP-IB Programming Reference

This chapter provides a reference for HP-IB operation of the HP 87510A. Use this information as a reference to the syntax requirements and general function of the individual commands.

This chapter lists the commands in alphabetical order. Refer to Appendix A for a functional list of the commands.

Refer to the *Reference Manual* for the details of each function, or to the *Service Manual* for the details of the service related functions.

HP-IB Command Syntax

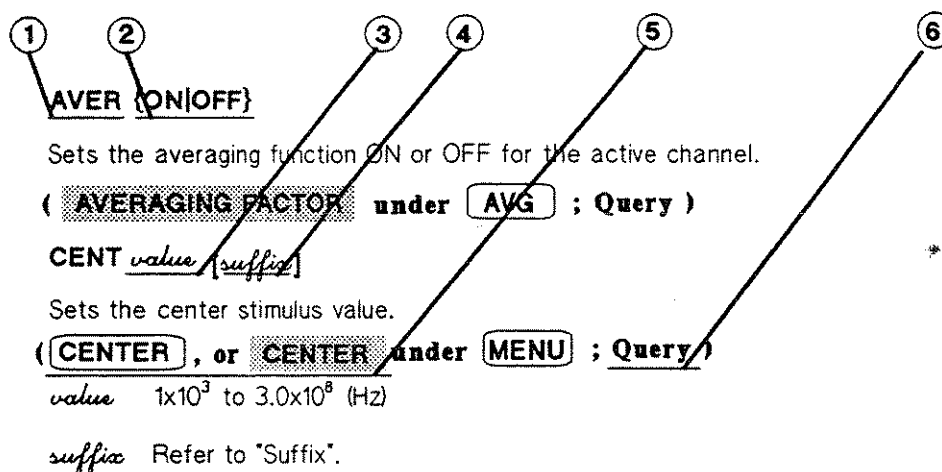

- ① Upper case bold characters represent the program codes which must appear exactly as shown with no embedded spaces. Upper and lower case characters are equivalent.
- ② Characters enclosed in the { } brackets are qualifiers attached to the root mnemonic. There can be no spaces or symbols between the root mnemonic and its appendage.

For example:

{ON|OFF} shows that either ON or OFF can be attached to the root mnemonic.
 AVER{ON|OFF} means AVERON or AVEROFF.

{1-4} shows that the numeral 1, 2, 3, or 4 can be attached to the root mnemonic.
 DELR{1-4} means DELR1, DELR2, DELR3, or DELR4.

- ③ A constant or a pre-assigned simple or complex numeric or string variable transferred to the HP 87510A. There must be a space between it and the code.
- ④ Square brackets indicate that the enclosed information is optional.

- ⑤ Key or softkey which has the same function.
- ⑥ "Query" indicates that the command can be queried. Refer to "Query Commands".

Note

A semicolon (;) is required as a separator for each program command except for the last command.

For example, either of the following is acceptable.

```
OUTPUT Hp87510;"CHAN1; AR; LOGM;"  
OUTPUT Hp87510;"CHAN1; AR; LOGM"
```

Query Commands

All instrument functions can be interrogated to find the current On/Off state or value.

For instrument state commands, append the question mark (?) character instead of {ON|OFF} to interrogate the state of the functions. The HP 87510A re to the next controller ENTER operation with a "1" or a "0" to indicate ON or OFF, respectively.

For setting functions such as SCAL *value*, using SCAL? causes the HP 87510A to respond to the next controller ENTER operation by the current function value output then clearing the instrument entry area.

If a command that does not have a defined response is interrogated, the instrument outputs a zero.

■ Example 1

AR

```
OUTPUT Hp87510;"AR?;"  
ENTER Hp87510;Reply  
PRINT "Input port is AR?",  
IF Reply THEN PRINT "Yes"  
IF NOT Reply THEN PRINT "No"
```

■ Example 2

CLASS11{A|B|C}

```
OUTPUT Hp87510;"CLASS11?;"  
ENTER Hp87510;Reply$  
PRINT "3 TERM calibration standard class is ";Reply$
```

■ Example 3

ADDRCONT *value*

```
OUTPUT Hp87510;"ADDRCONT?;"  
ENTER Hp87510;Reply  
PRINT "Controller HP-IB address is ";Reply
```

Suffix

The following suffixes can be used as the units of the command parameter:

Frequency:	Hz (default)
Power:	dBm (default)
Log mag:	dB (default)
Delay time:	s (default)
Phase:	deg (default)
Capacitance:	F (default)
Inductance:	H (default)
Impedance:	ohm (default)

If no suffix is used, the HP 87510A assumes the default values for the instruction. Upper and lower case characters are equivalent.

Code Naming Conventions

The HP-IB Commands of HP 87510A are derived from their front panel key titles (where possible), according to the naming conventions below.

Some codes require additional parameters (on, off, 1, 2, etc.). Codes that have no front panel equivalent are HP-IB only commands, and use a similar convention based on the common name of the function. Where possible, HP 87510A codes are compatible with HP 8751A, HP 8753 and HP 8510 codes.

Table 3-1. HP-IB Code Naming Conventions

Convention	For HP-IB Code Use	Example	
		Key Title	HP-IB Code
One word	First four letters	POWER START	POWE STAR
Two words	First three letters of first word and first letter of second word	ELECTRICAL DELAY SEARCH RIGHT	ELED SEAR
Two words in a group	First four letters of both	MARKER → CENTER	MARKCENT
Three Words	First three letters of first word, first letter of second word, and first four letters of third word	CAL KIT: 7MM SEARCH RNG STORE	CALK7MM SEARSTOR

HP 87510A Instrument Command Reference

ADDRCONT *value*

Sets the HP-IB address which the HP 87510A will use to communicate with an external controller.

(**ADDRESS: CONTROLLER** under **LOCAL**); Query)

value 0 to 30

ADDRPLOT *value*

Sets the HP-IB address which the HP 87510A will use to communicate with the plotter.

(**ADDRESS: PLOTTER** under **LOCAL**); Query)

value 0 to 30

ADDRPRIN *value*

Sets the HP-IB address which the HP 87510A will use to communicate with the printer.

(**ADDRESS: PRINTER** under **LOCAL**); Query)

value 0 to 30

ANA0CH1

Selects channel 1 for waveform analysis. For details, refer to Appendix E. (Query)

ANA0CH2

Selects channel 2 for waveform analysis. For details, refer to Appendix E. (Query)

ANA0DATA

Selects a data trace for waveform analysis. For details, refer to Appendix E. (Query)

ANA0MEMO

Selects a memory trace for waveform analysis. For details, refer to Appendix E. (Query)

ANARANG *value[suffix],value[suffix]*

Sets the waveform analysis stimulus range by entering the START and STOP values. For details, refer to Appendix E. (Query)

value 1 (kHz) to 3.0 (MHz)

suffix refer to "Suffix"

ANARFULL

Sets the analysis range equal to the full stimulus range. For details, refer to Appendix E.

AR

Calculates and displays the complex ratio of input A to input R.

(**A/R** under **MEAS**); Query)

ASCE string

Sets user defined extension for ASCII save file in MS-DOS format. Default setting is ".TXT". Modified extension is kept in SRAM even if power is OFF.

(**DEFINE EXTENSION ASCII DATA** under **SAVE**): Query)

string Extension name. Up to 3 characters

AUTO

Selects the scale/div value automatically to fit the trace data to the display.

(**AUTO SCALE** under **SCALE REF**)

AVER {ON|OFF}

Sets the averaging function ON or OFF for the active channel.

(**AVERAGING on off** under **AVG**); Query)

AVERFACT value

Sets the averaging factor.

(**AVERAGING FACTOR** under **AVG**); Query)

value 1 to 999

AVERREST

Resets and restarts averaging.

(**AVERAGING RESTART** under **AVG**)

BEEPDONE {ON|OFF}

Sets the operation completion beeper ON or OFF.

(**BEEP DONE on off** under **DISPLAY**); Query)

BEEPFAIL {ON|OFF}

Sets the limit fail beeper ON or OFF.

(**BEEP FAIL on off** under **(SYSTEM)**; Query)

BEEPWARN {ON|OFF}

Sets the warning beeper ON or OFF.

(**BEEP WARN on off** under **(DISPLAY)**; Query)

BINCLEL

Clears BIN sort table of active channel.

(**CLEAR LIST YES no** under **(SYSTEM)**)

BINEDONE

Completes editing the BIN sorting table.

(**DONE** under **(SYSTEM)**)

BINESB value

Sets to write a bit to the Event Status resistor B (ESB) if the result is sorted into the specified BIN.

value 0: Out of BIN
 1 to 16: BIN Number
 17: Not Write to ESB

BINL value

Sets lower limit of the BIN.

(**LOWER LIMIT** under **(SYSTEM)**)

value -5.0×10^5 to 5.0×10^5 (dB) (Log mag format)
 -5.0×10^5 to 5.0×10^5 (deg) (Phase and Expanded phase formats)
 -5.0×10^5 to 5.0×10^5 (s) (Delay format)
 -5.0×10^5 to 5.0×10^5 (Units) (Polar, Lin mag, Real, and Imaginary formats)

suffix refer to "Suffix"

BINO value

Sets the out of limit pattern (8 bit) of BIN sorting in decimal value.

value 0 to 255 (integer, decimal)

BINOA

Sets the output port of a BIN result to A port of 24-bit I/O port. (OUTPUT TO [A] under SYSTEM)

BINOB

Sets the output port of a BIN result to B port of 24-bit I/O port.

(OUTPUT TO [B] under SYSTEM)

BINP *value*

Sets the output pattern (8 bit) of BIN sorting as a decimal value.

value 0 to 255 (integer, decimal)

BINS {ON|OFF}

Sets BIN sorting test on or off.

(BIN SORT ON off under SYSTEM)

BINSADD

Adds a new BIN to the BIN sort table.

(ADD under SYSTEM)

BINSDEL

Deletes a selected BIN from the BIN sort table.

(DELETE under SYSTEM)

BINSDON

Complete editing a BIN.

(DONE under SYSTEM)

BINSEDI *value*

Selects BIN to edit.

(BIN under SYSTEM)

value BIN number. 1 to 16

BINSLINE {ON|OFF}

Sets BIN line display on or off.

(**BIN LINE on off** under **(SYSTEM)**)

BINU value[suffix]

Sets upper limit of the BIN.

(**UPPER LIMIT** under **(SYSTEM)**)

value -5.0×10^5 to 5.0×10^5 (dB) (Log mag format)
 -5.0×10^5 to 5.0×10^5 (deg) (Phase and Expanded phase formats)
 -5.0×10^5 to 5.0×10^5 (s) (Delay format)
 -5.0×10^5 to 5.0×10^5 (Units) (Polar, Lin mag, Real, and Imaginary formats)

suffix refer to "Suffix"

C0 value

Enters the constant term of the open circuit capacitor model value, C_0 .

(**C0** under **(CAL)**)

value 0 to 1,000 ($\times 10^{-15}$ F)

C1 value

Enters the constant term of the open circuit capacitor model value, C_1 .

(**C1** under **(CAL)**)

value 0 to 1,000 ($\times 10^{-27}$ F/Hz)

C2 value

Enters the constant term of the open circuit capacitor model value, C_2 .

(**C2** under **(CAL)**)

value 0 to 1,000 ($\times 10^{-36}$ F/Hz²)

CALCASSI

Shows the tabular listing of the calibration kit class assignment.

(**CLASS ASSIGNMENT** under **(COPY)**)

CALI parameter

Selects the measurement calibration type. (Query)

<i>parameter</i>	<i>description</i>
NONE	No calibration
RESP	Response measurement calibration
RAI	Response and isolation measurement calibration
S111	1-Port measurement calibration at port 1

CALIRAI

Selects the response and isolation measurement calibration.

(**RESPONSE & ISOL'N** under **CAL**); Query)

CALIRESP

Selects the response measurement calibration.

(**RESPONSE** under **CAL**); Query)

CALIS111

Selects the 1-port measurement calibration at port 1.

(**S11 1-PORT** under **CAL**); Query)

CALK parameter

Selects the calibration kit. (Query)

<i>parameter</i>	<i>description</i>
APC7	7 mm
N50	Type-N 50 Ω
N75	Type-N 75 Ω
USED	User-defined

CALK7MM

Selects the 7 mm calibration kit.

(**CAL KIT: 7mm** under **CAL**); Query)

CALKN50

Selects the 50 Ω type-N calibration kit.

(**N 50 Ω** under **CAL**); Query)

CALKN75

Selects the 75 Ω type-N calibration kit.

(**N 75 Ω** under **(CAL)**; Query)

CALKUSED

Selects a calibration kit model defined or modified by the user.

(**USER KIT** under **(CAL)**; Query)

CALN

Selects using no calibration.

(**CALIBRATE: NONE** under **(CAL)**; Query)

CALS *value*

Provides the tabular listing of the standard setting.

(**STD NO. 1** to **STD NO. 8** under **(COPY)**)

value 1 to 8

CENS *value1* [*suffix*], *value2* [*suffix*]

Sets center and span stimulus value.

(**(CENTER)** and **(SPAN)**; Query)

value1 Center stimulus; 1 (kHz) to 300 (MHz)
value2 Span stimulus; 0 (Hz) to 299.999 (MHz)
suffix refer to "Suffix"

CENT *value* [*suffix*]

Sets the center stimulus value.

(**(CENTER)**, or **CENTER** under **(MENU)**; Query)

value 1 (kHz) to 300 (MHz)
suffix refer to "Suffix"

CHAD *string*

Changes the current directory (only MS-DOS format).

(**CHANGE DIRECTORY** under **(SAVE)**)

string Directory path

CHAN1

Selects channel 1 as the active measurement channel. (CH 1); Query)

CHAN2

Selects channel 2 as the active measurement channel. (CH 2); Query)

CIN

Set port C of the 24-bit I/O port to be an input port.

CLAD

Completes specifying a class.

(CLASS DONE (SPE'D) under (CAL))

CLASS11 {A|B|C}

Selects port 1 (S11) one-port calibration standard class: S11A (open), S11B (short), or S11C (load).

([S11] : OPEN, SHORT, or LOAD under (CAL))

CLEL

Clears the current frequency list.

(CLEAR LIST YES under (MENU))

CLEM {1-8}

Clears the marker.

(MARKER 1 to MARKER 8 under (MKR))

CLES

Clears the status byte, the event status register, the event status register B, and the operational status register.

CONT

Continuous trigger.

(CONTINUOUS under (MENU); Query)

CONV parameter

Selects the measurement data conversion setting(impedance, admittance, or multiple phase).
(Query)

<i>parameter</i>	<i>description</i>
OFF	Conversion OFF
ZTRA	Z:transmission
YTRA	Y:transmission
ONEDS	Reciprocal (1/S)
MP4	Multiply phase by 4
MP8	Multiply phase by 8
MP16	Multiply phase by 16

CONV1DS

Expresses the data in inverse measured parameter values.

(1/S under MEAS); Query)

CONVMP {4|8|16}

Multiplies the current phase trace by a multiplier factor specified by a qualifier (4, 8, or 16).

(4 * Phase, 8 * Phase, 16 * Phase under MEAS); Query)

CONVOFF

Turns off all parameter conversion operations.

(OFF under MEAS); Query)

CONVYTRA

Converts transmission data to its equivalent admittance values.

(Y: Trans under MEAS); Query)

CONVZTRA

Converts transmission data to its equivalent impedance values.

(Z: Trans under MEAS); Query)

COPA

Aborts printing or plotting in progress.

(COPY ABORT under COPY)

COPT {ON|OFF}

Sets the time stamp function ON or OFF.

(**COPY TIME on off** under **COPY**); Query)

CORR {ON|OFF}

Sets the error correction function ON or OFF.

(**CORRECTION on off** under **CAL**); Query)

COUC {ON|OFF}

Sets the channel coupling of stimulus values ON or OFF.

(**COUPLED CH on off** under **MENU**); Query)

COUT

Sets port C of the 24-bit I/O port to be an output port.

CRED *string*

Create a directory (only MS-DOS format).

(**CREATE DIRECTORY** under **SAVE**)

string Up to 8 characters for directory name and up to 3 characters for extension

CURD?

Outputs current directory.

DATAM3TER

Displays calculated data using the following equation:

$$D = \frac{(M - E_2)}{(E_3 + E_4(D - E_2))}$$

Where,

- D* : Display data
- M* : Measured data
- E₂* : Defined by INPUDATM2 command
- E₃* : Defined by INPUDATM3 command
- E₄* : Defined by INPUDATM4 command

HP-IB Programming Reference

DATAMNONE

Displays measurement data without calculation.

DATAMTHRU

Displays calculated data using the following equation:

$$D = \frac{M}{E_1}$$

Where,

D : Display data
M : Measured data
E₁ : Defined by INPUDATM1 command

DAYMYEAR

Sets the displayed date mode to day/month/year order.

(**DayMonYear** under **SYSTEM**); Query)

DCBUS value

Selects the DC bus.

(Under **SERVICE MENU** under **SYSTEM**); Query)

value 0 to 20

DEFS value

Defines the number of the calibration standards to be modified.

(**DEFINE STANDARD** under **CAL**)

value 1 to 8

DELA

Selects the Delay format for the current measurement.

(**DELAY** under **FORMAT**); Query)

DELO

Sets the delta marker mode OFF.

(**Δ MODE OFF** under **MKR**); Query)

DELR {1-8}

Selects the delta reference marker.

(Δ REF = 1 to Δ REF = 8 under (MKR); Query)

DELRFIXM

Sets the user-specified fixed reference marker.

(Δ REF = Δ FIXED MKR under (MKR); Query)

DESTOFF

Sets destructive RAM testing OFF. (DATA in RAM will be restored when test is completed.)

(Under SERVICE MENU under (SYSTEM); Query)

DESTON

Sets destructive RAM testing ON. (DATA in RAM will be lost.)

(Under SERVICE MENU under (SYSTEM); Query)

DFLT

Outputs the plotting parameters to the default values.

(DEFAULT SETUP under (COPY))

DIN

Set port D of the 24-bit I/O port to be an input port.

DISA parameter

Selects the display allocation mode. (Query)

<i>parameter</i>	<i>description</i>
ALLI	All instrument
HIHB	Half instrument half BASIC
ALLB	All BASIC
BASS	BASIC status

DISAALLB

Displays only the HP Instrument BASIC display on the HP 87510A's CRT.

(ALL BASIC under (DISPLAY); Query)

DISAALLI

Displays only the measurement graticule on the HP 87510A's CRT.

(**ALL INSTRUMENT** under **DISPLAY**); Query)

DISABASS

Displays only the HP Instrument BASIC status on the HP 87510A's CRT.

(**BASIC STATUS** under **DISPLAY**); Query)

DISAHIHB

Displays the measurement graticule (top half) and the HP Instrument display (bottom half) on the HP 87510A's CRT.

(**HALF INSTR HALF BASIC** under **DISPLAY**); Query)

DISBLIST

Displays BIN sorting table on the HP 87510A's CRT.

DISFDOS

Sets the format for initializing the flexible disk in the internal disk drive in MS-DOS format.

(**DEFINE FORMAT, DOS** under **SAVE**); Query)

Supported MS-DOS formats are:

- 720 kbyte, 80 tracks, double-sided, 9 sector/track
- 1.44 Mbyte, 80 tracks, double-sided, 18 sector/track

DISFLIF

Sets the format for initializing the flexible disk in the HP 87510A's internal disk drive in LIF (Logical Interchange Format) format.

(**DEFINE FORMAT, LIF** under **SAVE**); Query)

DISG {ON|OFF}

Sets the graticule display on or off.

(**GRATICULE on off** under **DISPLAY**); Query)

DISL {1|2}

Selects list sweep table 1 or 2 to be displayed and hard copied.

(**DISL1** or **DISL2** under **COPY**)

DISLLIST

Displays the limit table on the display.

(**DISPLAY LIST** under **COPY**)

DISMCTSP

Displays the list sweep stimulus range in the center and span format.

(**CTR & SPAN** under **COPY**; Query)

DISMMD

Selects the middle and delta format for the limit testing table.

(**MID & DLT** under **COPY**; Query)

DISMNUM

Displays the list sweep stimulus resolution in the number of points format.

(**NUMBER of POINTS** under **COPY**; Query)

DISMSTEP

Displays the list sweep stimulus resolution in the step size format.

(**STEP SIZE** under **COPY**; Query)

DISMSTSP

Displays the list sweep stimulus range in the start and stop format.

(**DISP MODE: ST & SP** under **COPY**; Query)

DISMUL

Selects the upper and lower format for the limit testing table.

(**DISP MODE: UPR & LWR** under **COPY**; Query)

DISP *parameter*

Selects the display trace type. (Query)

<i>parameter</i>	<i>description</i>
DATA	Data only
MEMO	Memory only
DATM	Data and memory
DDM	Data divided by memory
DMM	Data minus memory

DISPDATA

Displays a trace of measured data.

DISPDATM

Displays traces of both measured data and memory data.

DISPDDM

Displays the trace of the results of measured data divided by memory data.

DISPDMM

Displays the trace of the results of measured data subtracted from memory data.

DISPMEMO

Displays a trace of memory data.

DIST {ON|OFF}

Sets the trace display on or off.

(TRACE on off under DISPLAY; Query)

DONE

Completes the measurement of the selected standard calibration.

(DONE: RESPONSE under CAL RESPONSE & ISOL'N)

DOUT

Sets D port of the 24-bit I/O port to output port.

DSKEY

Disables the front panel keys and the rotary knob. To enable the keys and knob again, send the ENKEY command.

DUAC {ON|OFF}

Selects the dual (ON) or single (OFF) channels display.

(DUAL CHAN on off under DISPLAY; Query)

EDITBINL

Begins editing the BIN sorting table.

(**EDIT BIN SORT LINE** under **SYSTEM**)

EDITDONE

Completes editing the frequency list for the list sweep.

(**LIST DONE** under **MENU**)

EDITLIML

Begins editing the limit line table.

(**EDIT LIMIT LINE** under **SYSTEM**)

EDITLIS1

Selects list 1 for editing.

(**EDIT LIST 1** under **MENU**; Query)

EDITLIS2

Selects list 2 for editing.

(**LIST 2** under **MENU**; Query)

EDITLIST

Begins editing the frequency list.

(**EDIT LIST** under **MENU**)

ELED *value* [s]

Sets the electrical delay.

(**ELECTRICAL DELAY** under **SCALE REF**; Query)

value -10 to 10 (s)

ENKEY

Re-enables the front panel keys and the rotary knob which have been disabled by the DSKEY command.

EQUCPARA?

Executes four element analysis of a crystal resonator, and outputs parameters, C_0 , C_1 , L_1 , and R_1 . For more information, refer to "EQUCPARA?" in Appendix E. (Data format: C_0 , C_1 , L_1 , R_1)

EQUCPARS?

Executes four elements analysis of a crystal resonator, and outputs parameters, C_0 , C_1 , L_1 , R_1 , f_s , f_a , f_r , f_1 , and f_2 . For more information, refer to "EQUCPARA?" in Appendix E. (Data format: C_0 , C_1 , L_1 , R_1 , f_s , f_a , f_r , f_1 , f_2)

ESB?

Outputs the event status register B value.

ESNB value

Specifies the bits of event status register B.

value 0 to 32,767 ($=2^{15}-1$)

EXET

Executes the service test.

(Under **SERVICE MENU** under **SYSTEM**)

EXPP

Selects the expanded phase format for the current measurement.

(**EXPANDED PHASE** under **FORMAT**; Query)

EXTRLOCK?

Outputs the state of the external reference (locked or unlocked).

(Under **SERVICE MENU** under **SYSTEM**)

EXTT parameter

Selects the external trigger mode. (Query)

<i>parameter</i>	<i>description</i>
OFF	External trigger OFF (internal trigger mode ON)
ONSWEE	On sweep
ONPOIN	On point
MAN	Manual trigger mode on point

EXTTOFF

Sets the internal measurement trigger mode (external trigger OFF).

(**TRIGGER: TRIG OFF** under **MENU**); Query)

EXTTON

Sets the external measurement trigger mode to ON. When triggered, one measurement sweep is executed.

(**EXT. TRIG ON SWEEP** under **MENU**); Query)

EXTTPOIN

Sets the external measurement trigger mode to ON. When triggered, one point is measured.

(**EXT. TRIG ON POINT** under **MENU**); Query)

FBUS value

Selects the frequency bus.

(Under **SERVICE MENU** under **SYSTEM**)

value 0 to 5

FILC string1,string2,string3,string4

Copies file on flexible and RAM disks.

<i>string1</i>	Source file name. String. Up to 12 characters.
<i>string2</i>	Source device name. "MEMORY" or "DISK"
<i>string3</i>	Destination file name. String. Up to 12 characters.
<i>string4</i>	Destination device name. "MEMORY" or "DISK"

FIRLPNOR

Sets first local PLL to NORMAL.

(Under **SERVICE MENU** under **SYSTEM**); Query)

FIRLPOPE

Sets first local PLL to OPEN.

(Under **SERVICE MENU** under **SYSTEM**); Query)

FIRR?

Outputs the firmware revision.

(Under **SERVICE MENU** under **SYSTEM**)

FMT parameter

Selects the display format. (Query)

<i>parameter</i>	<i>description</i>
LOGM	Log magnitude format
PHAS	Phase format
DELA	Delay format
POLA	Polar chart format
LINM	Linear magnitude format
REAL	Real format
IMAG	Imaginary format
EXPP	Expanded phase format
LOGMP	Log magnitude and phase format
LOGMD	Log magnitude and delay format

FNDAUTO

Sets FN DAC to AUTO.

(Under **SERVICE MENU** under **SYSTEM**; Query)

FNDMANU

Sets FN DAC to MANUAL.

(Under **SERVICE MENU** under **SYSTEM**; Query)

FNDVALU value

Sets the FN DAC value.

(Under **SERVICE MENU** under **SYSTEM**; Query)

value 0 to 255

FNVNARR

Sets the FN VCO to NARROW.

FNVNORM

Sets FN VCO to NORMAL.

(Under **SERVICE MENU** under **SYSTEM**; Query)

FNVOPEN

Sets the FN VCO to OPEN.

(Under **SERVICE MENU** under **SYSTEM**); Query)

FNVWIDE

Sets FN VCO to WIDE.

FORM2

Sets the IEEE 32-bit floating point format to transfer trace data and waveform analysis (Refer to Appendix E) data via HP-IB.

FORM3

Sets the IEEE 64-bit floating point format to transfer the trace data and waveform analysis (Refer to Appendix E) data via HP-IB.

FORM4

Sets the ASCII transfer format to transfer the trace data and waveform analysis (Refer to Appendix E) data via HP-IB.

FORM5

Sets MS-DOS format to transfer the trace data and waveform analysis (Refer to Appendix E) data via HP-IB.

FREQ

Erases the frequency annotation on the display. Preset to turn ON.

(**FREQUENCY BLANK** under **DISPLAY**); Query)

FULP

Selects full page plotting.

(**FULL PAGE** under **COPY**); Query)

GRAE string

Sets user defined extension for HP-GL file saved in MS-DOS format. Default setting is ".HPG". The modified extension is kept in SRAM even when power is turned OFF.

(**DEFINE EXTENSION GRAPHICS** under **SAVE**); Query)

string Extension name. Up to 3 characters

GRODAPER *value [pct]*

Sets the group delay aperture.

(**GROUP DELAY APERTURE** under **AVG**); Query)

value 1 to 200 (%)

HOLD

Holds the present measurement.

(**HOLD** under **MENU**); Query)

IFBW *value [suffix]*

Sets the bandwidth value for IF bandwidth reduction.

(**IF BW** under **AVG**); Query)

value 2, 20, 200, 1,000, 4,000, or 8,000(Hz)
suffix refer to "Suffix"

IFBWAUTO

Automatically selects the proper IF bandwidth for each measurement point.

(**IF BW AUTO** under **AVG**); Query)

IFRAUTO

Sets the auto range mode for the IF range of the selected channel.

(Under **SERVICE MENU** under **SYSTEM**); Query)

IFRCH?

Outputs the IF range set channel.

(Under **SERVICE MENU** under **SYSTEM**)

IFRX1

Sets the X1 range for the IF range.

(Under **SERVICE MENU** under **SYSTEM**); Query)

IFRX1X8

Sets X1, X8 range for the IF range.

(Under **SERVICE MENU** under **SYSTEM**); Query)

IFRX64

Sets X64 range for the IF range.

(Under **SERVICE MENU** under **SYSTEM**); Query)

IFRX8X1

Sets X8, X1 range for the IF range.

(Under **SERVICE MENU** under **SYSTEM**); Query)

IMAG

Displays only the imaginary (reactive) portion of the measured data in Cartesian format.

(**IMAGINARY** under **FORMAT**); Query)

INID

Initializes the disk in the built-in flexible disk drive.

(**INITIALIZE DISK** under **SAVE**/**RECALL**)

INP8IO

Inputs data from the 4-bit parallel input port to the HP 87510A. (option 005 only)

INP8IO?

Inputs data from the 4-bit parallel input port to the HP 87510A, and outputs the data to a computer.(option 005 only)

INPT?

Outputs value which tells whether there is pulse input at the Input1 port of the 24-bit I/O port. When there is pulse input at Input1, the return value is a 1. When there is not, the return value is a 0. Once INPT? returns 1, next INPT? query returns 0 until the next pulse input has occurred at Input1.

INPUCALC {01-03} *value*

Stores the measurement calibration error coefficient set real/imaginary pairs input via HP-IB into instrument memory. Refer to Appendix D for calibration array assignments.

value Complex number (Data format: real, imaginary)

INPUCALK *value*

Stores the calibration kit data transmitted by the OUTPCALK? command.

value Block data (Data format: HP 87510A internal format (714 bytes of binary data))

INPUD

Executes a 3-term calibration by using real data which are set with INPULOAA, INPUOPEA, and INPUSHOA commands.

INPUDATTP *value1, value2[suffix]*

Enters data to the *n*th point of a data trace.

value1 point number, *n*. 0 to 801
value2 input data. complex value. (Data format:Real, Imaginary)
suffix refer to "Suffix"

INPUDATM1 *value*

Inputs the complex parameter E_1 for the DATAMTHRU command. Default complex value is $1 + j0$.

value Complex number (Data format: real, imaginary)

INPUDATM2 *value*

Inputs the complex parameter E_2 for the DATAM3TER command. Default complex value is $0 + j0$.

value Complex value (Data format: real, imaginary)

INPUDATM3 *value*

Inputs the complex parameter E_3 for the DATAM3TER command. Default complex value is $0 + j0$.

value Complex value (Data format: real, imaginary)

INPUATM4 *value*

Inputs the complex parameter E4 for the DATAM3TER command. Default complex value is $1 + j0$.

value Complex value (Data format: real, imaginary)

INPUFORM *value*

Inputs formatted data.

value Complex value (Data format: real, imaginary)

INPULOAA *value*

Inputs the real LOAD data array for a 3-term calibration.

value Complex number (Data format: real, imaginary)

INPUMEM *value*

Inputs data to the memory array.

value Complex number (Data format: real, imaginary)

INPUMEMTP

Enters the *n*th point's memory-trace data. This command can only be used by the EXECUTE which is an HP instrument BASIC command.

value point number. 0 to 801

INPUOPEA *value*

Inputs the real OPEN data array for a 3-term calibration.

value Complex number (Data format: real, imaginary)

INPUSHOA *value*

Inputs the real SHORT data array for a 3-term calibration.

value Complex number (Data format: real, imaginary)

INPUTMEM *value*

Inputs data to the memory trace.

value Complex number (Data format: real, imaginary)

IOPO?

Returns the installed option number of the I/O port of the rear panel. If not option is installed, IOPO? returns string, "STD". If Option 005 is installed, IOPO? returns "005", and Option 006 is installed, IOPO? returns "006". (query only)

KEY value

Sends the key code for a key or a softkey on the front panel. This is equivalent to actually pressing a key. Refer to Appendix C for key codes.

value 0 to 49

KITD

Ends the calibration kit modification process.

(**KIT DONE** under **CAL**)

LABERES {I|P} string

Defines the label for response and isolation, or response class when modifying the calibration kit.

(**RESPONSE & ISOL'N** or **RESPONSE** under **CAL**)

string Up to ten characters may be used.

LABES11 {A|B|C} string

Defines the label for S11A (opens), S11B (shorts), or S11C (loads) class when modifying the calibration kit.

(**LABEL: S11A**, **S11B**, or **S11C** under **CAL**)

string Up to ten characters may be used.

LABK string

Defines the calibration kit label when modifying the calibration kit.

(**LABEL KIT** under **CAL**)

string Up to ten characters may be used.

LABS string

Defines the calibration standard label when modifying the calibration kit.

(**LABEL STD** under **CAL**)

string Up to ten characters may be used.

LEFL

Sets the plot quadrant to the lower left.

(**LEFT LOWER** under **COPY**); Query)

LEFU

Sets the plot quadrant to the upper left.

(**LEFT UPPER** under **COPY**); Query)

LIMCLEL

Clears all of segments in the limit test.

(**CLEAR LIST YES** under **SYSTEM**)

LIMD *value* [*suffix*]

Sets the limits delta value from the specified middle value.

(**DELTA LIMITS** under **SYSTEM**); Query)

value 0 to 5.0×10^5 (dB) (Log mag format)
 0 to 5.0×10^5 (deg) (Phase and Expanded phase formats)
 0 to 5.0×10^5 (s) (Delay format)
 0 to 5.0×10^5 (Units) (Polar, Lin mag, Real, and Imaginary formats)

suffix refer to "Suffix"

LIMEDONE

Completes editing the limit table.

(**DONE** under **SYSTEM**)

LIMIAMPO *value* [*suffix*]

Sets an amplitude offset value for limit testing.

(**AMPLITUDE OFFSET** under **SYSTEM**); Query)

value -5.0×10^5 to 5.0×10^5 (dB) (Log mag format)
 -5.0×10^5 to 5.0×10^5 (deg) (Phase and Expanded phase format)
 -5.0×10^5 to 5.0×10^5 (s) (Delay format)
 -5.0×10^5 to 5.0×10^5 (Units) (Polar, Lin mag, Real, and Imaginary formats)

suffix refer to "Suffix"

LIMLINE {ON|OFF}

Sets limit lines ON or OFF.

(LIMIT LINE on off under SYSTEM); Query)

LIMMAOF

Sets the active marker value to the amplitude offset for limit testing.

(MARKER → AMP. OFS under SYSTEM)

LIMIOPOIN

Sets the limit line test to execute at each measurement point.

(LMT TST ON [POINT] under SYSTEM)

LIMIOSEND

Sets the limit line test to execute at the end of the sweep.

(LMT TST ON [SWP END] under SYSTEM)

LIMISTIO *value [suffix]*

Sets a stimulus offset value for limit testing.

(STIMULUS OFFSET under SYSTEM); Query)

value -300 (MHz) to 300 (MHz)

suffix refer to "Suffix"

LIMITEST {ON|OFF}

Sets the limit testing ON or OFF.

(LIMIT TEST on off under SYSTEM); Query)

LIML *value [suffix]*

Sets the lower limit value for a limit testing segment.

(LOWER LIMIT under SYSTEM); Query)

value -5.0×10⁵ to 5.0×10⁵ (dB) (Log mag format)

-5.0×10⁵ to 5.0×10⁵ (deg) (Phase and Expanded phase formats)

-5.0×10⁵ to 5.0×10⁵ (s) (Delay format)

-5.0×10⁵ to 5.0×10⁵ (Units) (Polar, Lin mag, Real, and Imaginary formats)

suffix refer to "Suffix"

LIMM *value* [suffix]

Sets the middle value of delta limits.

(MIDDLE VALUE under (SYSTEM); Query)

value -5.0×10^5 to 5.0×10^5 (dB) (Log mag format)
 -5.0×10^5 to 5.0×10^5 (deg) (Phase and Expanded phase formats)
 -5.0×10^5 to 5.0×10^5 (s) (Delay format)
 -5.0×10^5 to 5.0×10^5 (Units) (Polar, Lin mag, Real, and Imaginary formats)

suffix refer to "Suffix"

LIMS *value* [suffix]

Sets the starting stimulus value of a limit testing segment.

(STIMULUS VALUE under (SYSTEM); Query)

value 1 (kHz) to 300 (MHz)

suffix refer to "Suffix"

LIMSADD

Adds a new segment to the end of the limit list.

(ADD under (SYSTEM))

LIMSDEL

Deletes a limit testing segment.

(DELETE under (SYSTEM))

LIMSDON

Completes editing the limit segments.

(DONE under (SYSTEM))

LIMSEDI *value*

Opens the segment to define or modify the stimulus and limit values.

(EDIT under (SYSTEM); Query)

value 1 to 18

LIMU *value* [*suffix*]

Sets the upper limit value for a limit testing segment.

(**UPPER LIMIT** under **SYSTEM**); Query)

value -5.0×10^5 to 5.0×10^5 (dB) (Log mag format)
 -5.0×10^5 to 5.0×10^5 (deg) (Phase and Expanded phase formats)
 -5.0×10^5 to 5.0×10^5 (s) (Delay format)
 -5.0×10^5 to 5.0×10^5 (Units) (Polar, Lin mag, Real, and Imaginary formats)

suffix refer to "Suffix"

LINFREQ

Activates a linear frequency sweep.

(**LIN FREQ** under **MENU**); Query)

LINM

Displays the linear magnitude format.

(**LIN MAG** under **FORMAT**); Query)

LINT {DATA|MEMO} *value*

Selects the line type of a trace for plotting.

(**LINE TYPE DATA** or **LINE TYPE MEMORY** under **COPY**)

value 0 to 7

LISDFBASE

Displays the measured data for the range between the minimum and maximum frequency set in the "Edit List Menu."

(**LIST DISP: FREQ BASE** under **MENU**); Query)

LISDOBASE

Displays the measured data for only the frequency ranges set in the "Edit List Menu."

(**ORDER BASE** under **MENU**); Query)

LISFREQ

Activates the frequency list sweep mode.

(**LIST FREQ** under **MENU**); Query)

LISSLIS1

Activates LIST 1 for the list sweep.

(**SWEEP BY: LIST 1** under **MENU**); Query)

LISSLIS2

Activates LIST 2 for the list sweep.

(**LIST 2** under **MENU**); Query)

LISV

Displays a tabular listing of all the stimulus values and their current measured values.

(**LIST VALUES** under **COPY**)

LMAX? value

Outputs the *n*th local maximum value from the left of range which is set by the ANARANG command. (Data format: local maximum)

value *n*, integer

LMIN? value

Outputs the *n*th local minimum value from the left of range which is set by the ANARANG command. (Data format: local minimum)

value *n*, integer

LOGFREQ

Activates log frequency sweep mode.

(**LOG FREQ** under **MENU**); Query)

LOGM

Displays in log magnitude format.

(**LOG MAG** under **FORMAT**); Query)

LOGMD

Displays the log magnitude trace and delay trace simultaneously.

(**LOG MAG & DELAY** under **FORMAT**); Query)

LOGMP

Displays the log magnitude trace and phase trace simultaneously.

(LOG MAG & PHASE under (FORMAT); Query)

MANTRIG

Triggers measurement at a single point.

(MANUAL TRG ON POINT under (MENU); Query)

MARD {ON|OFF}

Displays (ON) or does not display (OFF) markers and the marker information on the screen.
(Query)

MARK {1-8} *value* [*suffix*]

Selects the active marker, and moves it to the specified stimulus value.

(MARKER 1 to MARKER 8 under (MKR); Query)

value 1 (kHz) to 300 (MHz)

suffix refer to "Suffix"

MARK {STAR|STOP}

Changes the stimulus start or stop value to the active marker value.

(MARKER → START, MARKER → STOP under (MKR FCTN))

MARKBUCK *value*

Moves the active marker to specified data point number.

value 1 to "number of points"

MARKCENT

Changes the stimulus center value to the active marker value.

(MARKER → CENTER under (MKR FCTN))

MARKCONT

Interpolates between measured points to allow the markers to be placed at any point on the trace.

(CONTINUOUS under (MKR); Query)

MARKCOUP

Couples the marker stimulus values for the two display channels.

(**MARKERS: COUPLED** under **(MKR)**; Query)

MARKDISC

Places markers only on measured trace points determined by the stimulus settings.

(**MARKERS: DISCRETE** under **(MKR)**; Query)

MARKFAUV *value* [*suffix*]

Sets the fixed marker auxiliary value offset.

(**FIXED MKR AUX VALUE** under **(MKR)**; Query)

-5.0×10^6 to 5.0×10^6 (deg, polar format)

suffix refer to "Suffix"

MARKFSTI *value* [*suffix*]

Sets the fixed marker stimulus value offset.

(**FIXED MKR STIMULUS** under **(MKR)**; Query)

value -5 (GHz) to 5 (GHz)

suffix refer to "Suffix"

MARKFVAL *value* [*suffix*]

Sets the fixed marker position value offset.

(**FIXED MKR VALUE** under **(MKR)**; Query)

value -5.0×10^5 to 5.0×10^5 (dB) (Log mag format)
 -5.0×10^5 to 5.0×10^5 (deg) (Phase and Expanded phase formats)
 -5.0×10^5 to 5.0×10^5 (s) (Delay format)
 -5.0×10^5 to 5.0×10^5 (Units) (Polar, Lin mag, Real, and Imaginary formats)

suffix refer to "Suffix"

MARKL {ON|OFF}

Displays (ON) or does not display (OFF) the list of stimulus values and response values of all markers.

(**MKR LIST on off** under **(MKR)**; Query)

MARKMIDD

Sets the middle value for the delta limit using the active marker value.

(MIDDLE VALUE under (SYSTEM))

MARKODATA

Enables the marker to move on the measurement data trace.

(MARKERS ON [DATA] under (MKR); Query)

MARKOFF

Turns off all the markers and the delta reference marker.

(ALL MKR OFF under (MKR); Query)

MARKOMEMO

Enables the marker to move on the memory data trace.

(MARKERS ON [MEMO] under (MKR); Query)

MARKPEAD

Changes the differential stimulus value and the response value of the peak when searching for the local max, min, and peak-to-peak.

(MARKER → PEAK DEF under (MKR FCTN))

MARKREF

Changes the reference value to the active marker's response value, without changing the reference position.

(MARKER → REFERENCE under (SCALE REF) or (MKR FCTN))

MARKSPAN

Changes the start and stop values of the stimulus span to the active marker and the delta reference marker.

(MARKER → SPAN under (MKR FCTN))

MARKSTIM

Sets the stimulus value of a segment to the active marker value.

(MARKER → STIMULUS under (SYSTEM))

MARKTIME {ON|OFF}

Sets the x-axis marker readout to the sweep time (ON), or cancels the setting (OFF).

(**MARK TIME on off** under **(MKR)**; Query)

MARKUNCO

Allows the marker stimulus values to be controlled independently on each channel.

(**UNCOUPLED** under **(MKR)**; Query)

MARKZERO

Puts a fixed reference marker at the present active marker position, and makes the fixed marker stimulus and response values at that position equal to zero.

(**MKR ZERO** under **(MKR)**)

MEAS parameter

Selects the parameters or inputs to be measured. (Query)

<i>parameter</i>	<i>description</i>
AR	A/R measurement
A	A measurement
R	R measurement

MEASA

Measures the absolute power amplitude at input A.

(**A** under **(MEAS)**; Query)

MEASR

Measures the absolute power amplitude at input R.

(**R** under **(MEAS)**; Query)

MEASSTAT {ON|OFF}

Calculates and displays the mean, standard deviation, and peak-to-peak values among the search range (ON), or does not display them (OFF).

(**STATICS** under **(MKR FCTN)**; Query)

MODII

Leads to the modify calibration kit menu, where a calibration kit can be user-modified.

(**MODIFY** under **CAL**)

MONDYEAR

Changes the displayed date to the "month:day:year" format.

(**DATE MODE: MonDayYear** under **SYSTEM**; Query)

NEGL

Sets the output of the 24-bit I/O port to the negative logic.

NEXP

Displays the next page of information in a tabular listing onto the display.

(**NEXT PAGE** under **COPY**)

NEXPK?

Outputs the maximum local maximum value and its stimulus next to the value last found by the PEAK?, or NEXPK? commands. For more information, refer to Appendix E. (Data format: Local Maximum value, stimulus)

NUMG *value*

Triggers a user-specified number of sweeps, and returns to the HOLD mode.

(**NUMBER OF GROUPS** under **MENU**)

value Greater than 0

NUMLMAX?

Outputs the number of local maximums within the range set by the ANARANG command. (Data format: number)

NUMLMIN?

Outputs the number of local minimum within the range set by the ANARANG command. (Data format: number)

OFSD value [s]

Specifies the one-way electrical delay from the measurement (reference) plane to the standard.

(**OFFSET DELAY** under **CAL**)

value -10 to 10 (s)

OFSL value

Specifies energy loss, due to skin effect, along a one-way length of coaxial cable offset.

(**OFFSET LOSS** under **CAL**)

value 0 to 1.0×10^{19} (Ω/s)

OFSZ value [ohm]

Specifies the characteristic impedance of the coaxial cable offset.

(**OFFSET ZO** under **CAL**)

value 0.1 to 5.0×10^6 (Ω)

OPEP

Lists the key parameters for both channels 1 and 2 on the display.

(**OPERATING PARAMETERS** under **COPY**)

OPTI?

Returns installed option number of the front panel ports. If nothing is installed, OPTI? returns the string, "STD". If Option 004 (delete reference channel option) is installed, OPTI? returns "004". (query only)

OSE value

Enables the operational status register.

value 0 to 32,767

OSER?

Outputs the current value in the event register of an operational status register.

OSNT

Sets the negative transition filter of an operational status register. For details, refer to Appendix B. (Query)

OSPT

Sets the positive transition filter of an operational status register. For details, refer to Appendix B. (Query)

OSR?

Outputs the operational status register value.

OUT1ENVH

Sets OUTPUT1 set to HIGH when a pulse input has occurred at INPUT1.

OUT1ENVL

Sets OUTPUT1 set to LOW when a pulse input has occurred at INPUT1.

OUT1H

Sets OUTPUT1 to HIGH.

OUT1L

Sets OUTPUT1 to LOW.

OUT2ENVH

Sets OUTPUT2 set to HIGH when a pulse input has occurred at INPUT1.

OUT2ENVL

Sets OUTPUT2 set to LOW when a pulse input has occurred at INPUT1.

OUT2H

Sets OUTPUT2 to HIGH.

OUT2L

Sets OUTPUT2 to LOW.

OUT8IO *value*

Outputs the data to the 8-bit parallel output port. (Option 005 only)

value 0 to 255

OUTAIO value

Output decimal data specified as the parameter to port A (8 bit) of the 24-bit I/O port.
value 0 to 255

OUTBIO value

Output decimal data specified as the parameter to port B (8 bit) of the 24-bit I/O port.
value 0 to 255

OUTCIO value

Output decimal data specified as the parameter to port C (4 bit) of the 24-bit I/O port.
value 0 to 15

OUTDIO value

Output decimal data specified as the parameter to port D (4 bit) of the 24-bit I/O port.
value 0 to 15

OUTEIO value

Output decimal data specified as the parameter to port E (8 bit) of the 24-bit I/O port.
value 0 to 255

OUTFIO value

Output decimal data specified as the parameter to port F (16 bit) of the 24-bit I/O port.
value 0 to 65535

OUTGIO value

Output decimal data specified as the parameter to port G (20 bit) of the 24-bit I/O port.
value 0 to 1048575

OUTHIO value

Output decimal data specified as the parameter to port H (24 bit) of the 24-bit I/O port.
value 0 to 16777215

OUTPCALC {01-03}?

Outputs the active calibration set array of the active channel (Data format: real, imaginary).
Refer to Appendix D for the calibration set array.

OUTPCALK?

Outputs the active calibration kit. (Data format: block data (714 bytes of binary data))

OUTPCFIL? *value1,value2,value3,value4,value5,value6*

Outputs filter parameters within the range specified by the ANARANG command. Command parameter sets nominal frequency, the offset of $x1$ dB and $x2$ dB to the maximum peak value to determine the cutoff points, same parameter with POLE?, and f_1 and f_2 for determining rejection level and spurious level respectively. For details, refer to Appendix E. (Data format: loss, const loss, bandwidth, center frequency, Q, $\Delta L.F1$, $\Delta R.F1$, $\Delta L.F2$, $\Delta R.F2$, passband ripple, rejection level, spurious level, pole_x1, pole_stimulus1, pole_x2, pole_stimulus2)

<i>value1</i>	center frequency, fc
<i>value2</i>	$x1$
<i>value3</i>	$x2$
<i>value4</i>	POLE? parameter
<i>value5</i>	$f1$
<i>value6</i>	$f2$
<i>suffix</i>	refer to "Suffix"

OUTPDATAT?

Outputs data trace value on 16 points stimulus which is set by the STIDROUT command. If there are points that is not set by the STIDROUT command, the OUTPDATAT? returns the value at 100 kHz. (Data format: real \times 16)

OUTPDATTP?

Outputs the data-trace data at the specified point (Data format: real, imaginary).

value 1 to "number of points"

OUTPERRO?

Outputs the error message in the error queue (Data format: Error number (ASCII), "string").

OUTPFAIP?

Outputs number of the failed point of the limit test.

OUTPFBUS?

Outputs the FBUS data.

(Under **SERVICE MENU** under **SYSTEM**)

OUTPFILT? *value*[*suffix*]

Outputs filter parameters within the range specified by the ANARANG command. Command parameter sets the offset of x dB to the maximum peak value to determine the cutoff points. For details, refer to Appendix E. (Data format: loss, bandwidth, center frequency, Q, Δ L.F, Δ R.F)

value Relative offset value from maximum
suffix refer to "Suffix"

OUTPFORM?

Outputs the formatted trace data (Data format: real, imaginary)

OUTPFORMP? *value*

Outputs the formatted trace data at the specified point (Data format: real, imaginary)

value 1 to "number of points"

OUTPIFORM?

Outputs the formatted data from the inactive channel (Data format: real, imaginary)

OUTPINPSIO?

Outputs the data entered from the 4-bit parallel input port. (option 005 only)

OUTPINPCIO?

Outputs the data entered from port C (4 bit) of the 24-bit I/O port.

OUTPINPDIO?

Outputs the data entered from port D (4 bit) of the 24-bit I/O port.

OUTPINPEIO?

Outputs the data entered from port E (8 bit) of the 24-bit I/O port.

OUTPIRFORM?

Outputs the real part of the formatted data from the inactive channel.

OUTPIRTMEM?

Outputs the real part of the trace memory data from the inactive channel.

OUTPITMEM?

Outputs the trace memory data from the inactive channel. (Data format: real, imaginary)

OUTPLIMF?

Outputs the limit test results only for the failed points. (Data format: stimulus, result (0 for fail, -1 for no test), upper limit, lower limit; Form 4)

OUTPLIML?

Outputs the limit test results for each point. (Data format: stimulus, result (1 for pass, 0 for fail, -1 for no test), upper limit, lower limit; Form 4)

OUTPLIMM?

Outputs the limit test result for the marker position. (Data format: stimulus, result (1 for pass, 0 for fail, -1 for no test), upper limit, lower limit)

OUTPMARK?

Outputs the active marker values. (Data format: marker value, marker aux. value, stimulus)

OUTPMAX?

Outputs the maximum value within the range specified with the ANARANG command. For details, refer to Appendix E. (Data format: maximum, stimulus)

OUTPMEAN?

Outputs the mean value within the range specified with the ANARANG command. For details, refer to Appendix E. (Data format: mean)

OUTPMEMO?

Outputs the memory data from the active channel. (Data format: real, imaginary)

OUTPMEMOT?

Outputs memory trace value on 16 points stimulus which is set by the STIMROUT command. If there are points that is not set by STIMROUT command, OUTPMEMOT? returns the value at 100 kHz. (Data format: real × 16)

OUTPMEMTTP? *value*

Outputs the memory data at a specified point. (Data format: real, imaginary)

value 1 to "number of points"

OUTPMIN?

Outputs the minimum value within the range specified with the ANARANG command. For details, refer to Appendix E. (Data format: minimum, stimulus)

OUTPMINMAX?

Outputs the maximum and minimum values within the range specified with the ANARANG command. For details, refer to Appendix E. (Data format: maximum, stimulus, minimum, stimulus)

OUTPMSTA?

Outputs the marker statistics. (Data format: mean, standard deviation, peak to peak)

OUTPMWID?

Outputs the results of the bandwidth search. (Data format: bandwidth, center, Q)

OUTPMWIL?

Outputs the results of the bandwidth search with the insertion loss value. (Data format: bandwidth, center, Q, and loss)

OUTPMWLF?

Outputs the results of the bandwidth search with the insertion loss, the difference between the center frequency and the lower cutoff frequency ($\Delta L.F$), and the difference between the center frequency and the upper cutoff frequency ($\Delta R.F$) values. (Data format: bandwidth, center, Q, loss, $\Delta L.F$, and $\Delta R.F$)

OUTPRESF? *value1,value2*

Returns the stimulus of the maximum local-maximum and its $x1$ dB below points of both sides, and the stimulus of minimum local-minimum and its $x2$ dB above points of both sides. For more details, refer to Appendix E.

value1
value2

OUTPRESO?

Outputs the series resonant (Resonant) and parallel resonant (Anti-Resonant) parameters, 0° phase point frequency fr (Resonant frequency) and fa (Anti-Resonant frequency), and the corresponding gain values Gr and Ga. For details, refer to Appendix E. (Data format: Gr, fr, Ga, fa)

OUTPRESR?

Outputs same parameter as OUTPRES0? and maximum difference, rpl1 of local maximum and its left local minimum on left of resonant point, maximum difference, rpl2 of local maximum and its right local minimum between resonant and anti-resonant points, and the maximum difference, rpl3 of the local maximum and its left local minimum on the right of the anti-resonant point. For details, refer to Appendix E. (Data format:Gr, fr, Ga, fa, rpl1, rpl2, rpl3)

OUTPRFORM?

Outputs the real part of the formatted data from the active channel.

OUTPRTMEM?

Outputs the real part of the trace memory data from the active channel.

OUTPSTIM?

Outputs the stimulus array data from the active channel.

OUTPTESS? *value*

Outputs the specified test number's result.

(Under **SERVICE MENU** under **SYSTEM**)

value 0 to 85

OUTPTITL?

Outputs the display title for the active channel (less than 54 characters).

OUTPTMEM?

Outputs the memory trace data from the active channel. (Data format: real, imaginary)

OUTPTMEMP? *value*

Outputs the memory trace data from the active channel at a specified point. (Data format: real, imaginary)

value 1 to "number of points"

OUTPXFIL? *value1,value2,value3,value4,value5*

Outputs filter parameters within the range specified by the ANARANG command. Command parameter sets the offset of $x1$ dB and $x2$ dB to the maximum peak value to determine the cutoff points, same parameter as POLE?, and f_1 and f_2 for determining the rejection level and the spurious level respectively. For details, refer to Appendix E. (Data format:loss, bandwidth, center frequency, Q, $\Delta L.F1$, $\Delta R.F1$, $\Delta L.F2$, $\Delta R.F2$, passband ripple, rejection level, spurious level, pole_x1, pole_stimulus1, pole_x2, pole_stimulus2)

value1 $x1$
value2 $x2$
value3 POLE? parameter

value4 f1
value5 f2
suffix refer to "Suffix"

PARS {ON|OFF}

Sets the partial search of the marker search function on or off.

(PART SRCH on off under MKR FCTN); Query)

PEADX *value* [*suffix*]

Defines the differential stimulus value of the peak for searching for the local max, min, and peak-to-peak.

(PEAK DEF: ΔX under MKR FCTN); Query)

value -5000 to 5000 (MHz) (Frequency sweep)
suffix refer to "Suffix".

PEADY *value* [*suffix*]

Defines the differential response value of the peak for searching for the local max, min, and peak-to-peak.

(ΔY under MKR FCTN); Query)

value -5.0×10⁵ to 5.0×10⁵ (dB) (Log mag format)
 -5.0×10⁵ to 5.0×10⁵ (deg) (Phase and Expanded phase formats)
 -5.0×10⁵ to 5.0×10⁵ (s) (Delay format)
 -5.0×10⁵ to 5.0×10⁵ (Units) (Polar, Lin mag, Real, and Imaginary formats)
suffix refer to "Suffix".

PEAK?

Outputs the maximum local maximum value and its stimulus within range which is set by the ANARANG command. For more information, refer to Appendix E. (Data format: maximum Local-maximum value, stimulus)

PHAO *value* [deg]

Adds or subtracts a phase offset.

(PHASE OFFSET under SCALE REF); Query)

value -360 to +360 (deg).

PHAS

Displays a Cartesian format of the phase portion of the data, measured in degrees.

(PHASE under FORMAT); Query)

PLOALL

Selects plotting all the information displayed on the display except for the softkey.

(**PLOT: ALL** under **COPY**); Query)

PLOC *parameter*

Selects the plot elements. (Query)

<i>parameter</i>	<i>description</i>
DONLY	Data only
DGRAT	Data and graticule
ALL	All information displayed

PLODGRAT

Selects the measured data and memory data with the graticules for plotting.

(**DATA & GRATCL** under **COPY**); Query)

PLODONLY

Selects the measured data and the memory data without the graticules for plotting.

(**DATA ONLY** under **COPY**); Query)

PLOS {**FAST**|**SLOW**}

Sets the plotting speed to fast or slow.

(**PLOT SPEED** under **COPY**)

PLOT

Plots the display to a graphics plotter.

(**PLOT** under **COPY**)

POIN *value*

Sets the number of the data points per sweep.

(**NUMBER of POINTS** under **MENU**); Query)

value 2 to 801.

POLA

Displays in the polar format.

(**POLAR** under **FORMAT**); Query)

POLE? value

Outputs the first found local minimum for both side from the maximum point below the value which is the subtracted parameter from the maximum value. For example, to specify as -10 dB down, a command parameter becomes a -10. For more information, refer to Appendix E. (Data format: left local minimum, stimulus, right local minimum, stimulus)

value

POLM parameter

Selects the polar marker. (Query)

<i>parameter</i>	<i>description</i>
LOG	Log
LIN	Linear
RI	Real and imaginary

POLMLIN

Displays the linear magnitude and the phase of the active polar marker.

(**LIN MKR** under **MKR**); Query)

POLMLOG

Displays the logarithmic magnitude and the phase of the active polar marker.

(**LOG MKR** under **MKR**); Query)

POLMRI

Displays a real and imaginary pair of the active polar marker.

(**Re/Im MKR** under **MKR**); Query)

PORE {ON|OFF}

Sets the reference plane extension mode ON or OFF.

(**EXTENSIONS on off** under **CAL**); Query)

PORTA value [s]

Adds electrical delay to the input A reference plane for any A input measurements including S-parameters.

(**EXTENSION INPUT A** under **CAL**); Query)

value -10 to 10 (s)

PORTR value [s]

Adds electrical delay to extend the reference plane at input R to the end of cable.

(**EXTENSION INPUT R** under **CAL**); Query)

value -10 to 10 (s)

POSL

Sets output of the 24-bit I/O port to the positive logic.

POWE value [dBm]

Sets the source output level.

(**POWER** under **MENU**); Query)

value -15 to +5 (dBm)

PREP

Displays the previous page of information in a tabular listing.

(**PREV PAGE** under **COPY**)

PRES

Presets the instrument state. (**PRESET**)

PRINALL

Copies the measurement display to the printer according to plotting options.

(**PRINT** under **COPY**)

PSOFT {ON|OFF}

Selects the plot softkey label option ON or OFF.

PURG string

Removes a file saved on the disk in the built-in flexible disk drive.

(PURGE FILE under (SAVE) (RECALL))

string File name, up to 10 characters including the extension

QUAD parameter

Selects the quadrant plot setting.

<i>parameter</i>	<i>description</i>
LEFU	Upper left
LEFL	Lower left
RIGU	Upper right
RIGL	Lower right
FULP	Full-size

RAID

Completes the response and isolation calibration.

(DONE RESP ISOL'N CAL under (CAL))

RAISOL

Selects the isolation class for the response and isolation calibration.

(ISOL'N STD under (CAL))

RAIRESP

Selects the response class for the response and isolation calibration.

(RESPONSE under (CAL))

REAL

Displays only the real (resistive) portion of the measured data in Cartesian format.

(REAL under (FORMAT); Query)

RECCOFF

Sets the receiver correction OFF.

(Under SERVICE MENU under (SYSTEM); Query)

RECCON

Sets the receiver correction ON.

(Under **SERVICE MENU** under **SYSTEM**); Query)

RECD *string*

Loads the instrument states or data from the disk in the built-in flexible disk drive.

(**RECALL FILE** under **SAVE/RECALL**)

string File name, Up to 10 characters including the extension

REFP *value*

Sets the position of the reference line on the graticule of a Cartesian format.

(**REFERENCE POSITION** under **SCALE REF**); Query)

value 0 to 10 (Div)

REFV *value [suffix]*

Changes the value of the reference line, moving the measurement trace correspondingly.

(**REFERENCE VALUE** under **SCALE REF**); Query)

value -500 to 500 (dB) (Log mag format)
-5.0×10⁶ to 5.0×10⁶ (deg) (Phase or Expanded phase formats)
-0.5 to 0.5 (s) (Delay format)
1.0×10⁻¹¹ to 500 (Units) (Polar formats)
-5.0×10⁶ to 5.0×10⁶ (Units) (Lin man, Real, or Imaginary formats)

suffix refer to "Suffix"

RESAVD *string*

Updates an already saved file on the disk in the built-in flexible disk drive.

(**RE-SAVE FILE** under **SAVE**)

string File name up to 10 characters including the extension

RESC

Resumes the last measurement calibration sequence.

(**RESUME CAL SEQUENCE** under **CAL**)

RESD

Turns off the tabular listing and returns the measurement display to the screen.

(**RESTORE DISPLAY** under **COPY**)

RESPDONE

Completes the response calibration.

(**DONE: RESPONSE** under **CAL**)

REST

Aborts the sweep in progress, then restarts the measurement.

(**MEASURE RESTART** under **MENU**)

RFOPNORM

Sets the RF OSC PLL to NORMAL.

(Under **SERVICE MENU** under **SYSTEM**; Query)

RFOPOPEN

Sets the RF OSC PLL to OPEN.

(Under **SERVICE MENU** under **SYSTEM**; Query)

RIGL

Draws a quarter-page plot in the lower right quadrant of the page.

(**RIGHT LOWER** under **COPY**; Query)

RIGU

Draws a quarter-page plot in the upper right quadrant of the page.

(**RIGHT UPPER** under **COPY**; Query)

RPLENV?

Searches all sets of neighboring peaks and their included valleys for the maximum perpendicular height from the valley minimum point included between neighboring peaks, to the intersection of an imaginary slope line drawn between the maximum peak points of the neighboring peaks in range specified by ANARANG, and outputs the resultant data via HP-IB. For details, refer to Figure E-7 in Appendix E.

RPLHEI?

Searches for the maximum height between neighboring ripple peaks and outputs the resultant data via HP-IB. For details, refer to Figure E-3 in Appendix E.

RPLLHEI?

Searches for the maximum height between neighboring ripple peaks (measured from the ripple maximum peak point to the valley minimum point to the left of the ripple peak) and outputs the resultant data via HP-IB. For details, refer to Figure E-6 in Appendix E.

RPLMEA?

Averages all heights between neighboring local maximums and minimums within a specified range and outputs the result by HP-IB. If no ripple is detected, a zero is returned. For details, refer to "RPLMEA?" in Appendix E in Figure E-8 in Appendix E.

RPLPP?

Searches for the maximum ripple peak to peak value and outputs the resultant data via HP-IB. For details, refer to Figure E-1 in Appendix E.

RPLRHEI?

Searches for the maximum height between neighboring ripple peaks (measured from the ripple peak to the valley point to the right of the ripple peak) and outputs the resultant data via HP-IB. For details, refer to "RPLRHEI? and RPLLHEI?" in Appendix E in Appendix E.

RPLVAL?

Outputs the maximum sum of the difference between the local minimum and the both sides local maximum, and the stimulus of the corresponding local minimum within range which is specified by ANARANG command. For more information, refer to Appendix E. (Data format: sum, stimulus)

SADD

Adds a new segment to a list sweep table.

(**ADD** under **MENU**)

SAV1

Saves the 1-port calibration results.

(**DONE: 1-PORT CAL** under **CAL**)

SAVC

Re-draws a trace using current error coefficient array data.

SAVCA {ON|OFF}

Selects whether or not the calibration coefficients arrays are to be saved.

(**CAL ARY on off** under **(SAVE)**; Query)

SAVDALL *string*

Saves the instrument states, the data array, and the memory array to the disk in the built-in flexible disk drive.

(**SAVE ALL** under **(SAVE)**)

string File name, up to 8 characters

SAVDASC "*string*"

Save the current measurement data in ASCII file format.

(**ASCII SAVE DATA ONLY** under **(SAVE)**)

string File name, up to 8 characters

SAVDDAT *string*

Saves the internal data arrays which is defined by the SAVCA{ON|OFF}, SAVTA{ON|OFF}, and SAVTMA{ON|OFF}.

(**SAVE DATA ONLY** under **(SAVE)**)

string File name up to 8 characters

SAVDGRA "*string*"

Saves the current display image in an HP-GL file.

(**ASCII SAVE GRAPHICS** under **(SAVE)**)

string File name up to 8 characters

SAVDSTA *string*

Saves only the instrument states and the calibration coefficients to the disk in the built-in flexible disk drive.

(**SAVE STATE ONLY** under **(SAVE)**)

string File name up to 8 characters

SAVEUSEK

Stores the user-modified or user-defined calibration kit into memory.

(**SAVE USER KIT** under **CAL**)

SAVTA {ON|OFF}

Sets the trace arrays to be saved (ON) or not (OFF).

(**TRACE ARY on off** under **SAVE**; Query)

SAVTMA {ON|OFF}

Sets the memory trace arrays to be saved (ON) or not (OFF).

(**T.MEM ARY on off** under **SAVE**; Query)

SCAC

Couples the data and memory trace to be scaled.

SCAFDATA

Selects the data trace to be scaled.

(**SCALE FOR [DATA]** under **SCALE REF**; Query)

SCAFMEMO

Selects the memory trace to be scaled.

(**SCALE FOR [MEMORY]** under **SCALE REF**; Query)

SCAL *value* [*suffix*]

Changes the response value scale per graticule division.

(**SCALE/DIV** under **SCALE REF**; Query)

<i>value</i>	0.001 to 500 (dB/div) (Log mag format)
	0.01 to 500 (deg/div) (Phase format)
	1.0×10^{-11} to 10,000 (deg) (Expanded phase format)
	1.0×10^{-14} to 10 (s/div) (Delay format)
	1.0×10^{-11} to 10,000 (Units FS) (Polar format)
	1.0×10^{-11} to 10,000 (Units/div) (Lin mag, Real, and Imaginary formats)
<i>suffix</i>	refer to "Suffix"

SCAPFULL

Selects the normal full size scale for plotting.

(**SCALE: FULL** under **COPY**)

SCAPGL

Fits the lower graticule to the user-defined P1 and P2.

(**LOWER GRATICULE** under **COPY**)

SCAPGU

Fits the upper graticule to the user-defined P1 and P2.

(**UPPER GRATICULE** under **COPY**)

SCAU

Uncouples the data and memory trace to be scaled.

SDEL

Deletes a segment from a list sweep table.

(**DELETE** under **MENU**)

SDON

Completes editing a segment of a list sweep table.

(**SEGMENT DONE** under **MENU**)

SEAL

Searches the trace for the next occurrence of the target value to the left of the marker.

(**SEARCH LEFT** under **MKR FCTN**)

SEALMAX

Moves the active marker to the maximum peak point on the trace in the search range.

(**LOCAL MAX** under **MKR FCTN**; Query)

SEALMIN

Moves the active marker to the minimum peak point on the trace in the search range.

(**LOCAL MIN** under **(MKR FCTN)**; Query)

SEAM parameter

Selects the marker search function. (Query)

<i>parameter</i>	<i>description</i>
OFF	Marker search function OFF
MAX	Maximum
MIN	Minimum
TARG	Target
MEAN	Mean
LMAX	Local maximum
LMIN	Local minimum
PPEAK	Peak to peak

SEAMAX

Moves the active marker to the maximum point on the trace.

(**MAX** under **(MKR FCTN)**; Query)

SEAMEAN

Moves the active marker to the mean point on the trace.

(**SEARCH: MEAN** under **(MKR FCTN)**; Query)

SEAMIN

Moves the active marker to the minimum point on the trace.

(**MIN** under **(MKR FCTN)**; Query)

SEAOFF

Turns off the marker search function.

(**SEARCH: OFF** under **(MKR FCTN)**; Query)

SEAPPEAK

Moves the active marker and the delta reference marker to the maximum peak point and the minimum peak point on the trace in the search range.

(**PEAK-PEAK** under **(MKR FCTN)**; Query)

SEAR

Searches the trace for the next occurrence of the target value to the right of the marker.

(**SEARCH RIGHT** under **(MKR FCTN)**)

SEARSTOR

Stores the search range, which is defined between the active marker and the delta reference marker.

(**SEARCH RNG STORE** under **(MKR FCTN)**)

SEATARG *value [suffix]*

Places the active marker at a specified target point on a trace.

(**TARGET** under **(MKR FCTN)**; Query)

value -5.0×10^5 to 5.0×10^5 (dB) (Log mag format)
 -5.0×10^5 to 5.0×10^5 (deg) (Phase and Expanded phase formats)
 -5.0×10^5 to 5.0×10^5 (s) (Delay format)
 -5.0×10^5 to 5.0×10^5 (Units) (Polar, Lin mag, Real, and Imaginary format)

suffix refer to "Suffix"

SEDI *value*

Determines a segment of a list sweep table to be modified.

(**SEGMENT** under **(MENU)**; Query)

value 1 to 31

SELD

Executes the self diagnostics.

(Under **SERVICE MENU** under **(SYSTEM)**)

SETCDATE *year,month,day*

Changes date of the internal clock.

(**MONTH**, **DAY**, and **YEAR** under **(SYSTEM)**; Query)

year 1901 to 2059
month 1 to 12
day 1 to 31

SETCTIME *hour,min,sec*

Changes time of the internal clock.

(**HOUR**, **MIN**, and **SEC** under **SYSTEM**); Query)

<i>hour</i>	0 to 23
<i>min</i>	0 to 59
<i>sec</i>	0 to 59

SETZ *value [ohm]*

Sets the characteristic impedance used by the HP 87510A in calculating measured impedance with conversion parameters.

(**SET 20** under **CAL**); Query)

<i>value</i>	0.1 to 5.0×10^6 (Ω)
--------------	---------------------------------------

SING

Makes a single measurement sweep, then sets the HOLD mode.

(**SINGLE** under **MENU**)

SMOO {ON|OFF}

Sets the smoothing function to ON or OFF.

(**SMOOTHING on off** under **AVG**); Query)

SMOOPER *value [pct]*

Changes the value of the smoothing aperture as a percent of the span.

(**SMOOTHING APERTURE** under **AVG**); Query)

<i>value</i>	0.05 to 100 (%)
--------------	-----------------

SOUOFF

Sets the source correction to OFF.

(Under **SERVICE MENU** under **SYSTEM**); Query)

SOUCON

Sets the source correction to ON.

(Under **SERVICE MENU** under **SYSTEM**); Query)

SPAN *value* [*suffix*]

Sets the frequency span of a segment about a specified center frequency.

(SPAN) or SPAN under (MENU); Query)

value 0 to 299.999 (MHz)
suffix refer to "Suffix"

SPECRESI *value*,[*value*,[*value*,[*value*,[*value*,[*value*,[*value*]]]]]]]

Enters the standard numbers to specify standard class required for a response and isolation calibration.

(RESPONSE * ISOL'N under (CAL))

value 1 to 8

SPECRESP *value*,[*value*,[*value*,[*value*,[*value*,[*value*,[*value*]]]]]]]

Enters the standard numbers to specify standard class required for a response calibration.

(RESPONSE under (CAL))

value 1 to 8

SPECS11A *value*,[*value*,[*value*,[*value*,[*value*,[*value*,[*value*]]]]]]]

Enters the standard numbers to specify the first standard class (S_{11A}) required for an S₁₁ 1-port calibration.

(SPECIFY: S11A under (CAL))

value 1 to 8

SPECS11B *value*,[*value*,[*value*,[*value*,[*value*,[*value*,[*value*]]]]]]]

Enters the standard numbers to specify the second standard class (S_{11B}) required for an S₁₁ 1-port calibration.

(S11B under (CAL))

value 1 to 8

SPECS11C *value*,[*value*,[*value*,[*value*,[*value*,[*value*,[*value*]]]]]]]

Enters the standard numbers to specify third standard class (S_{11C}) required for an S₁₁ 1-port calibration.

(S11C under (CAL))

value 1 to 8

Reference

SPLD {ON|OFF}

Sets the dual channel display mode: a full-screen single graticule display (OFF), or a split display with two half-screen graticules (ON).

(**SPLIT DISP on off** under **DISPLAY**); Query)

STAN {A-C}

Measures the calibration standard in the current standard class.

(**OPEN, SHORT, THRU** under **CAL**)

STAR value [suffix]

Defines the start frequency of the stimulus. (**START**); Query)

Sets the start frequency of a segment.

(**SEGMENT START** under **MENU**); Query)

value 1(kHz) to 300 (MHz)

suffix refer to "Suffix"

STAS value1 [suffix], value2 [suffix]

Sets start and stop stimulus values.

(**START** and **STOP**)

value1 start frequency. 1 (kHz) to 300 (MHz)

value2 stop frequency. 1 (kHz) to 300 (MHz)

suffix refer to "Suffix"

STDD

Completes the current standard definition.

(**STD DONE (DEFINED)** under **CAL**)

STDT parameter

Selects the standard type. (Query)

<i>parameter</i>	<i>description</i>
OPEN	Open
SHOR	Short
LOAD	Load
DELA	Transmission line
ARBI	Arbitrary impedance

STDTARBI

Defines the standard type to LOAD with an arbitrary impedance.

(**ARBITRARY IMPEDANCE** under **CAL**); Query)

STDTDELA

Defines the standard type as transmission line of specified length.

(**DELAY/THRU** under **CAL**); Query)

STDTLOAD

Defines the standard type as LOAD (termination).

(**LOAD** under **CAL**); Query)

STDTOPEN

Defines the standard type as an OPEN.

(**OPEN** under **CAL**); Query)

STDTSHOR

Defines the standard type as a SHORT.

(**SHORT** under **CAL**); Query)

STIDROUT{1-16} value [suffix]

Sets stimulus of data trace up to 16 for OUTPDATAT? query. To execute STIDROUT? query, pass a number as the parameter.

value 1 (kHz) to 300 (MHz)
suffix refer to "Suffix"

STIMROUT{1-16} value [suffix]

Sets stimulus of memory trace up to 16 for OUTPDATAT? query. To execute STIDROUT? query, pass a number as the parameter.

value 1 (kHz) to 300 (MHz)
suffix refer to "Suffix"

STODDISK

Selects internal flexible disk drive for mass storage device.

STODMEMO

Selects RAM disk drive for mass storage device.

STOP *value* [*suffix*]

Defines the stop value of the stimulus. (**STOP**; Query)

Sets the stop frequency of a segment.

(**STOP** under **MENU**); Query)

value 1 (kHz) to 300 (MHz)

suffix refer to "Suffix"

STPSIZE *value* [*suffix*]

Specifies the frequency step for a list sweep table.

(**STEP SIZE** under **MENU**); Query)

value 0 to 299.999 (MHz)

suffix refer to "Suffix"

SWET *value* [s]

Manually sets the sweep time.

(**SWEEP TIME** under **MENU**); Query)

value 6.0×10^{-4} to 86,400 (s)

SWETAUTO

Automatically sets the sweep time.

(**SWEEP TIME AUTO** under **MENU**); Query)

SWPT *parameter*

Selects the sweep type. (Query)

<i>parameter</i>	<i>description</i>
LINF	Linear frequency
LOGF	Log frequency
LIST	Frequency list

TARL? *value*

Outputs stimulus of first found point which has value specified by parameter of this command from right of range which is set by ANARANG command. For more information, refer to Appendix E. (Data format: stimulus)

value 1 (kHz) to 300 (MHz)

suffix refer to "Suffix"

TARL? value

Outputs stimulus of first found point which has value specified by parameter of this command from right of range which is set by ANARANG command. For more information, refer to Appendix E. (Data format: stimulus)

value 1 (kHz) to 300 (MHz)
suffix refer to "Suffix"

TARR? value

Outputs stimulus of first found point which has value specified by parameter of this command from left of range which is set by ANARANG command. For more information, refer to Appendix E. (Data format: stimulus)

value 1 (kHz) to 300 (MHz)
suffix refer to "Suffix"

TERI value [ohm]

Specifies the (arbitrary) impedance of the standard.

(**TERMINAL IMPEDANCE** under **CAL**)

value 0 to 10,000 (Ω)

TESC

Continues the test.

(Under **SERVICE MENU** under **SYSTEM**)

TEST value

Selects the test number.

(Under **SERVICE MENU** under **SYSTEM**; Query)

value 0 to 85

THRR value

Specifies threshold height of peak for waveform analysis command. Waveform analysis commands ignore ripples which has less height than specified value.

value -5.0×10^5 to 5.0×10^5 (dB) (Log mag format)
 -5.0×10^5 to 5.0×10^5 (deg) (Phase and Expanded phase formats)
 -5.0×10^5 to 5.0×10^5 (s) (Delay format)
 -5.0×10^5 to 5.0×10^5 (Units) (Polar, Lin mag, Real, and Imaginary formats)

suffix refer to "Suffix"

TITL *string*

Sends the string to the title area on the display.

(**TITLE** under **DISPLAY**); Query)

string up to 53 characters

TRACK {ON|OFF}

Tracks the search at the specified target value with each new sweep.

(**TRACKING on off** under **MKR FCTN**); Query)

VELOFACT *value*

Enters the velocity factor used by the HP 87510A to calculate the equivalent electrical length.

(**VELOCITY FACTOR** under **CAL**); Query)

value 0 to 10

WIDSIN

Searches for the cutoff point on the trace within the current cutoff points.

(**SEARCH IN** under **MKR FCTN**)

WIDSOUT

Searches for the cutoff point on the trace outside of the current cutoff points.

(**SEARCH OUT** under **MKR FCTN**)

WIDT {ON|OFF}

Sets the bandwidth search feature (ON) or not (OFF).

(**WIDTHS on off** under **MKR FCTN**); Query)

WIDV *value* [*suffix*]

Sets the amplitude parameter that defines the start and stop points for a bandwidth search.

(**WIDTH VALUE** under **MKR FCTN**); Query)

value -5.0×10^5 to 5.0×10^5 (dB) (Log mag format)
 -5.0×10^5 to 5.0×10^5 (deg) (Phase and Expanded phase formats)
 -5.0×10^5 to 5.0×10^5 (s) (Delay format)
 -5.0×10^5 to 5.0×10^5 (Units) (Polar, Lin mag, Real, and Imaginary formats)

suffix refer to "Suffix"

***CLS**

Clears the status byte register, the event register of the standard operation status register structure, and the standard event status register.

***ESE value**

Sets the enable bits of the standard status register. (Query)

value 0 to 255 (decimal expression of enable bits of the operation status register)

***ESR?**

Outputs the contents of the standard event status register.

***IDN?**

Outputs the HP 87510A ID. (Data format: manufacturer, model, serial no., firmware rev.)

***OPC**

Tells the HP 87510A to set bit 0 (Operation Complete bit) in the standard event status register when it completes all pending operations. (Query)

***PCB value**

Specifies the address of a controller that is temporarily passing HP-IB control to the HP 87510A.

value 0 to 30

***RST**

Resets the HP 87510A to its initial settings.

***SRE value**

Sets the enable bits of the status byte register. (Query)

value 0 to 255 (decimal expression of enable bits of the status byte register)

***STB?**

Reads the status byte by reading the master summary status bit.

***TRG**

Triggers the HP 87510A when the trigger mode is set to EXTERNAL trigger.

***TST?**

Executes an internal self-test and returns the test result.

***WAI**

Makes the HP 87510A wait until all previously sent commands are completed.



HP-IB Commands Summary

This appendix summarizes the HP-IB instrument commands of the HP 8751A according to the their softkey labels.

Active Channel Block

CHAN1	CH 1
CHAN2	CH 2

Response Function Block

MEAS Key

Input Port Menu

AR	A/R
MEASA	A
MEASR	R
MEAS <i>parameter</i>	

Conversion Menu

CONVOFF	OFF
CONVZTRA	Z: Trans
CONVYTRA	Y: Trans
CONV1DS	1/S
CONV MP{4 8 16}	4 * Phase 8 * Phase 16 * Phase
CONVMP{4 8 16}	4 * Phase 8 * Phase 16 * Phase
CONV <i>parameter</i>	

FORMAT Key

Format Menu

LOGM	LOG MAG
PHAS	PHASE
DELA	DELAY
LINM	LIN MAG
EXPP	EXPANDED PHASE
LOGMP	LOG MAG & PHASE
LOGMD	LOG MAG & DELAY

Format More Menu

REAL	REAL
IMAG	IMAGINARY
POLA	POLAR
FMT <i>parameter</i>	

SCALE REF Key

Scale Reference Menu

AUTO	AUTO SCALE
SCAL <i>value</i>	SCALE/DIV
REFP <i>value</i>	REFERENCE POSITION
REFV <i>value</i>	REFERENCE VALUE
MARKREF	MARKER → REFERENCE
SCAFDATA	SCALE FOR [DATA]
SCAFMEMO	SCALE FOR [MEMORY]

Electrical Delay Menu

ELED <i>value</i>	ELECTRICAL DELAY
PHAO <i>value</i>	PHASE OFFSET

DISPLAY Key

Display Menu

DUAC{ON OFF}	DUAL CHAN on off
SPLD{ON OFF}	SPLIT DISP on off
TITL <i>string</i>	TITLE
DIST{ON OFF}	TRACE on off

Display More Menu

BEEPDONE{ON OFF}	BEEP DONE on off
BEEPWARN{ON OFF}	BEEP WARN on off
DISG	GRATICULE on off
FREQ	FREQUENCY BLANK

Display Allocation Menu

DISAALLI	ALL INSTRUMENT
DISAIIHB	HALF INSTR HALF BASIC
DISAALLB	ALL BASIC
DISABASS	BASIC STATUS
DISA <i>parameter</i>	

AVG Key

Average Menu

AVERREST	AVERAGING RESTART
AVERFACT <i>value</i>	AVERAGING FACTOR
AVER{ON OFF}	AVERAGING on off
SMOOPER <i>value</i>	SMOOTHING APERTURE
SMOO{ON OFF}	SMOOTHING on off
GRODAPER <i>value</i>	GROUP DELAY APERTURE
IFBW <i>value</i>	IF BW

IF Bandwidth Menu

IFBWAUTO	IF BW AUTO
----------	------------

CAL Key

Correction Menu

CORR{ON OFF}	CORRECTION on off
RESC	RESUME CAL SEQUENCE

Select Cal Kit Menu

CALK7MM	CAL KIT: 7mm
CALKN50	N 50Ω
CALKN75	N 75Ω
CALKUSED	USER KIT
SAVEUSEK	SAVE USER KIT
MODI1	MODIFY
CALK <i>parameter</i>	

Calibrate More Menu

VELOFACT <i>value</i>	VELOCITY FACTOR
SETZ <i>value</i>	SET Z0

Reference Plane Menu

PORE{ON OFF}	EXTENSIONS on off
PORTR <i>value</i>	EXTENSION INPUT R
PORTA <i>value</i>	EXTENSION INPUT A

Calibration Menu

CALN	CALIBRATE: NONE
CALIRESP	RESPONSE
CALIRAI	RESPONSE & ISOL'N
CALIS111	3TERM S11-1PORT
CALI <i>parameter</i>	

Response Cal Menu

STANA	SHORT
STANB	OPEN
STANC	THRU
RESPDONE	DONE: RESPONSE

Response and Isolation Cal Menus

RAIRESP	RESPONSE
DONE	DONE: RESPONSE
RAIISOL	ISOL'N STD
RAID	DONE RESPONSE ISOL'N CAL

3-Term Cal Menus

CLASS11A	[S11] : OPEN
CLASS11B	SHORT
CLASS11C	LOAD
SAV1	DONE: 1-PORT CAL

Modify Cal Kit Menu

LABK	LABEL KIT
KITD	KIT DONE

Define Standard Menu

DEFS <i>value</i>	STD NO. 1 TO STD NO. 8
STDOPEN	OPEN

STDTSHOR	SHORT
STDTLOAD	LOAD
STDTDELA	DELAY/THRU
STDTARBI	ARBITRARY IMPEDANCE
C0 <i>value</i>	C0
C1 <i>value</i>	C1
C2 <i>value</i>	C2
TERI <i>value</i>	TERMINAL IMPEDANCE
LABS <i>string</i>	LABEL STD
STDD	STD DONE (DEFINED)
STDT <i>parameter</i>	

Specify Offset Menu

OFSD <i>parameter</i>	OFFSET DELAY
OFSL <i>parameter</i>	OFFSET LOSS
OFSZ <i>parameter</i>	OFFSET Z0

Specify Class Menus

SPECS11A <i>value,value,...</i>	SPECIFY: S11A
SPECS11B <i>value,value,...</i>	S11B
SPECS11C <i>value,value,...</i>	S11C
SPECRESP <i>value,value,...</i>	RESPONSE
SPECRESI <i>value,value,...</i>	RESPONSE & ISOL'N
CLAD	CLASS DONE (SPE'D)

Label Class Menus

LABES11A	LABEL: S11A
LABES11B	S11B
LABES11C	S11C
LABERESP	RESPONSE
LABERESI	RESPONSE & ISOL'N

(MKR) Key

Marker Menu

MARKOFF	ALL MKR OFF
MARKODATA	MARKERS ON [DATA]
MARKOMEMO	MARKERS ON [MEMORY]
MARKL{ON OFF}	MKR LIST on off
MARKZERO	MKR ZERO

Active Marker Menu

MARK{1-8} *value* MARKER 1 to 8

Clear Marker Menu

CLEM{1-8} MARKER 1 to 8

Delta Marker Mode Menu

DELRFIXM ΔREF=Δ FIXED MKR

DELO Δ MODE OFF

Delta Marker Menu

DELR{1-8} Δ REF=1 to Δ REF=8

Fixed Marker Menu

MARKFSTI *value* FIXED MKR STIMULUS

MARKFVAL *value* FIXED MKR VALUE

MARKFAUV *value* FIXED MKR AUX VALUE

Marker Mode Menu

MARKDISC MARKERS: DISCRETE

MARKCONT CONTINUOUS

MARKCOUP MARKERS: COUPLED

MARKUNCO UNCOUPLED

MARKTIME{ON|OFF} MKR TIME on off

Polar Marker Menu

POLMLIN LIN MKR

POLMLOG LOG MKR

POLMRI Re/Im MKR

POLM *parameter*

MKR FCTN Key

Marker Function Menu

MARKSTAR MARKER → START

MARKSTOP MARKER → STOP

MARKCENT MARKER → CENTER

MARKSPAN MARKER → SPAN

MARKREF MARKER → REFERENCE

MEASTAT{ON|OFF} STATISTICS

Search Range Menu

SEARSTOR	SEARCH RNG STORE
PARS{ON OFF}	PART SRCH on off

Marker Search Menu

SEAOFF	SEARCH: OFF
SEAMAX	MAX
SEAMIN	MIN
SEATARG <i>value</i>	TARGET
TRACK{ON OFF}	TRACKING on off

Target Menu

SEATARG	TARGET
SEAL	SEARCH LEFT
SEAR	SEARCH RIGHT

Marker Search More Menu

SEAMEAN	SEARCH: MEAN
SEALMAX	LOCAL MAX
SEALMIN	LOCAL MIN
SEAPPEAK	PEAK-PEAK
MARKPEAD	MARKER → PEAK DEF
PEADX <i>value</i>	PEAK DEF: ΔX
PEADY <i>value</i>	ΔY
SEAM <i>parameter</i>	

Width Menu

WIDV <i>value</i>	WIDTH VALUE
WIDSIN	SEARCH IN
WIDSOUT	SEARCH OUT
WIDT{ON OFF}	WIDTHS on off

SPCL FNCT Key

Special Function Menu

OUTPFILT? -3	-3 dB BAND WIDTH
OUTPFILT? <i>value</i>	-X dB BAND WIDTH and BAND WIDTH VALUE
EQUCPARA	EQUIVALENT CKT

Waveform Analysis Setting Menu

ANAOCH1	ANALY ON [CH1]
ANAOCH2	ANALY ON [CH2]
ANAODATA	ANALY FOR [DATA]
ANAOMEMO	ANALY FOR [SUB]
ANARANGE	ANALY MIN RANGE and ANALY MAX RANGE

Stimulus Function Block

STAR <i>value</i>	START
STOP <i>value</i>	STOP
CENT <i>value</i>	CENTER
SPAN <i>value</i>	SPAN
STAS <i>value1,value2</i>	START and STOP
CENS <i>value1,value2</i>	CENTER and SPAN

MENU Key

Stimulus Menu

POWE <i>value</i>	POWER
POIN <i>value</i>	NUMBER of POINTS
REST	MEASURE RESTART
COUC{ON OFF}	COUPLED CH on off

Sweep Time Menu

SWET <i>value</i>	SWEEP TIME
SWETAUTO	SWEEP TIME AUTO

Trigger Menu

HOLD	HOLD
SING	SINGLE
NUMG	NUMBER OF GROUPS
CONT	CONTINUOUS
EXTTOFF	TRIGGER: TRIG OFF
EXTTON	EXT. TRIG ON SWEEP
EXTTPOIN	EXT. TRIG ON POINT
MANTRIG	MANUAL TRG ON POINT
EXTT <i>parameter</i>	

Sweep Type Menu

LINFREQ	LIN FREQ
LOGFREQ	LOG FREQ
LISFREQ	LIST FREQ [LIST 1] or LIST FREQ [LIST 2]
LISDFBASE	LIST DISP: FREQ BASE
LISDOBASE	ORDER BASE
EDITLIST	EDIT LIST
SWPT <i>parameter</i>	

List Sweep Menu

LISSLIS1	SWEEP by: LIST 1
LISSLIS2	LIST 2

Edit List Menu

EDITLIS1	EDIT: LIST 1
EDITLIS2	LIST 2
SEDI <i>value</i>	SEGMENT
SDEL	DELETE
SADD	ADD
CLEL	CLEAR LIST
EDITDONE	LIST DONE

Edit Segment Menu

MARKSTAR	MKR → START
MARKSTOP	MKR → STOP
POIN	NUMBER of POINTS
STPSIZE <i>value</i>	STEP SIZE
POWE <i>value</i>	POWER
IFBW <i>value</i>	IF BW
SDON	SEGMENT DONE

Edit Segment More Menu

STAR <i>value</i>	SEGMENT: START
STOP <i>value</i>	STOP
CENT <i>value</i>	CENTER
SPAN <i>value</i>	SPAN

Clear List Menu

CLEL	CLEAR LIST YES
------	----------------

Instrument State Function Block

SYSTEM Key

Real Time Clock Menu

SETCTIME <i>hour, min, sec</i>	TIME HH:MM:SS
SETCDATE <i>year, month, day</i>	DATE MM:DD:YY
MONDYEAR	DATE MODE: MonDayYear
DAYMYEAR	DayMonYear

BIN Sort Menu

BINSLINE	BIN LINE on off
BINS	BIN SORT on off
BINOA	OUTPUT TO [A PORT]
BINOB	OUTPUT TO [B PORT]
EDITBINL	EDIT BIN SORT LINE

BIN Sort Edit Menu

BINSEDI	BIN
BINESB	BIN for ESB
BINSDEL	DELETE
BINSADD	ADD
BINSDON	DONE

BIN Sort Table Edit Menu

BINU	UPPER LIMIT
BINL	LOWER LIMIT
BINP	OUTPUT PATTERN
BINO	OUT OF LMT PATTERN
BINEDONE	DONE

Clear Menu

BINCLEL	CLEAR LIST YES
---------	----------------

Limits Menu

LIMILINE{ON OFF}	LIMIT LINE on off
LIMITEST{ON OFF}	LIMIT TEST on off
BEEPFAIL{ON OFF}	BEEP FAIL on off
LIMIOPOIN	LMT TST ON [POIN]
LIMIOEND	LMT TST ON [SWP END]

EDITLIML

EDIT LIMIT LINE

Edit Limits Menu

LIMSEDI *value*

EDIT or SEGMENT

LIMSDEL

DELETE

LIMSADD

ADD

LIMEDONE

DONE

Edit Segment Menu

LIMS *value*

STIMULUS VALUE

MARKSTIM

MARKER → STIMULUS

LIMU *value*

UPPER LIMIT

LIML *value*

LOWER LIMIT

LIMD *value*

DELTA LIMITS

LIMM *value*

MIDDLE VALUE

MARKMIDD

MARKER → MIDDLE

LIMSDON

DONE

Clear List Menu

LIMCLEL

CLEAR LIST YES

Offset Limit Menu

LIMISTIO *value*

STIMULUS OFFSET

LIMIAMPO *value*

AMPLITUDE OFFSET

LIMIMAOF

MARKER → AMP. OFS

LOCAL Key

ADDRPLOT *value*

ADDRESS: PLOTTER

ADDRPRIN *value*

ADDRESS: PRINTER

ADDRCONT *value*

ADDRESS: CONTROLLER

PRESET Key

PRES

PRESET

COPY Key

Copy Menu

PRINALL	PRINT
PLOT	PLOT
COPA	COPY ABORT
COPT{ON OFF}	COPY TIME on off
DFLT	DEFAULT SETUP

Select Quadrant Menu

LEFU	LEFT UPPER
LEFL	LEFT LOWER
RIGU	RIGHT UPPER
RIGL	RIGHT LOWER
FULP	FULL PAGE

QUAD *parameter*

Define Plot Menu

PLOALL	PLOT: ALL
PLODGRATY	DATA & GRATICLE
PLODONL	DATA ONLY
LINTDATA	LINE TYPE DATA
LINTMEMO	LINE TYPE SUB
PLOFAST	PLOT SPEED [FAST]
PLOSSLOW	PLOT SPEED [SLOW]

PLOC *parameter*

Scale Plot Menu

SCAPFULL	SCALE: FULL
SCAPGU	UPPER GRATICULE
SCAPGL	LOWER GRATICULE

Copy More Menu

LISV	LIST VALUES
OPEP	OPERATING PARAMETERS
DISBLIST	BIN SORT TABLE

Copy Cal Kit Menu

CALCASSI	CLASS ASSIGNMENT
----------	------------------

Copy Standard Number Menu

CALS *value* STD NO.1 to STD NO.8

Copy List Sweep Menu

DISL1 DISPLAY: LIST1
DISL2 LIST2
DISMSTP DISP MODE: ST & SP
DISMCTP DISP MODE: CTR & SPAN
DISMNUM NUMBER of POINTS
DISMSTEP STEP SIZE

Copy Limit Test Menu

DISLLIST DISPLAY LIST
DISMUL DISP MODE: UPR & LWR
DISMMD MID & DLT

Screen Menu

PRINALL PRINT [STANDARD]
PLOT PLOT
COPA COPY ABORT
COPT{ON|OFF} COPY TIME on off
DFLT DEFAULT SETUP
NEXP NEXT PAGE
PREP PREV PAGE
RESD RESTORE DISPLAY

SAVE and **RECALL** Keys

Save Menu

SAVDALL ALL
SAVDSTA STATE ONLY
SAVDDAT DATA ONLY
RESAVD *string* RE-SAVE FILE
STODDISK STOR DEV [DISK]
STODMEMO STOR DEV [MEMORY]

Title Menu

STODDISK STOR DEV [DISK]
STODMEMO STOR DEV [MEMORY]

ASCII Save Menu

SAVDGRA	GRAPHICS
SAVDASC	DATA ONLY

Define Extension Menu

GRAE	GRAPHICS [.HPG]
ASCE	ASCII DATA [.TXT]

Define Save Data Menu

SAVCA{ON OFF}	CAL ARY on off
SAVTA{ON OFF}	TRACE ARY on off
SAVTM{ON OFF}	SUB ARY on off

Disk Menu

PURG <i>string</i>	PURGE FILE
CRED	CREATE DIRECTORY
CHAD	CHANGE DIRECTORY
INID	INITIALIZE DISK
DISFLIF	INITIALIZE DISK [LIF]
DISFDOS	INITIALIZE DISK [DOS]
STODDISK	STOR DEV [DISK]
STODMEMO	STOR DEV [MEMORY]

Recall Menu

RECD <i>string</i>	RECALL FILE
--------------------	-------------

Service Function

DCBUS <i>value</i>	IFRCH?
DESTOFF	IFRX1
DESTON	IFRX1X8
EXET	IFRX64
EXTRLOCK?	IFRX8X1
FBUS <i>value</i>	OUTPFBUS?
FIRLPNOR	OUTPTESS? <i>value</i>
FIRLPOPE	RECCOFF
FIRR?	RECCON
FNDAUTO	REOPNORM
FNDMANU	REOPOPEN
FNDVALU <i>value</i>	SELD
FNVNARR	SOUCOFF
FNVNORM	SOUCON
FNVOPEN	TESC
FNVWIDE	TEST <i>value</i>
IFRAUTO	

IEEE 488.2 Common Commands

- *CLS
- *ESE *value*
- *ESE?
- *ESR?
- *IDN?
- *OPC
- *OPC?
- *PCB *value*
- *RST
- *SRE *value*
- *SRE?
- *STB?
- *TRG
- *TST?
- *WAI

Commands Which Don't Have Equivalent Softkey Labels

CIN	MARKBUCK <i>value</i>	OUTPLIMF?
CLES	NEGL	OUTPLIML?
COUT	NEXPK?	OUTPLIMM?
CURD	NUMLMAX?	OUTPMARK?
DATAM3TER	NUMLMIN?	OUTPMAX?
DATAMNONE	OPTI?	OUTPMEAN?
DATAMTHRU	OSE <i>value</i>	OUTPMEMO?
DIN	OSER?	OUTPMEMOP? <i>value</i>
DISP	OSNT	OUTPMEMOT
DISPDATA	OSPT	OUTPMIN?
DISPDATM	OSR?	OUTPMINMAX?
DISPDDM	OUT1ENVH	OUTPMSTA?
DISPDMM	OUT1ENVL	OUTPMWID?
DISPMEMO	OUT1H	OUTPMWIL?
DOUT	OUT1L	OUTPMWLF?
DSKEY	OUT2ENVH	OUTPRESO?
ENKEY	OUT2ENVL	OUTPRESR?
EQUCPARS?	OUT2H	OUTPRESR?
ESB?	OUT2L	OUTPRFORM?
ESNB <i>value</i>	OUT8IO <i>value</i>	OUTPRTMEM?
FORM2	OUTAIO <i>value</i>	OUTPSTIM?
FORM3	OUTBIO <i>value</i>	OUTPTIIL?
FORM4	OUTCIO <i>value</i>	OUTPTMEM?
FORM5	OUTDIO <i>value</i>	OUTPTMEMP? <i>value</i>
INP8IO	OUTEIO <i>value</i>	OUTPXFIL? <i>x1,x2,D,f1,f2</i>
INP8IO?	OUTFIO <i>value</i>	PEAK?
INPT?	OUTGIO <i>value</i>	POLE? <i>value</i>
INPUCALC{01-03} <i>value</i>	OUTHIO <i>value</i>	POSL
INPUCALK <i>value</i>	OUTPCALC{01-03}?	PSOFT{ON OFF}?
INPUD	OUTPCALK?	RPLENV?
INPUDATAP <i>value</i>	OUTPCFIL? <i>fc,x1,x2,D,f1,f2</i>	RPLHEI?
INPUDATM1 <i>real,imag</i>	OUTPDATAP? <i>value</i>	RPLLHEI?
INPUDATM2 <i>real,imag</i>	OUTPDATAT?	RPLMEA?
INPUDATM3 <i>real,imag</i>	OUTPERRO?	RPLPP?
INPUDATM4 <i>real,imag</i>	OUTPFAIP?	RPLRHEI?
INPUFORM <i>value</i>	OUTPFORM?	RPLVAL?
INPULOAA <i>values</i>	OUTPFORMP? <i>value</i>	SAVC
INPUOPEA <i>values</i>	OUTPIFORM?	SCAC
INPUSHOA <i>values</i>	OUTPINP8IO	SCAU
INPUTMEM <i>value</i>	OUTPINPCIO?	STIDROUT <i>number,value</i>
IOPO?	OUTPINPDIO?	STIMROUT <i>number,value</i>
KEY <i>value</i>	OUTPINPEIO?	TARL? <i>value</i>
LMAX? <i>value</i>	OUTPIRFORM?	TARR? <i>value</i>
LMIN? <i>value</i>	OUTPIRTMEM?	THRR <i>value</i>
MARD	OUTPITMEM?	

Status Reporting

Status byte totals three status registers which indicate the internal condition of an instrument. Figure B-1 shows the status reporting structure of the HP 87510A.

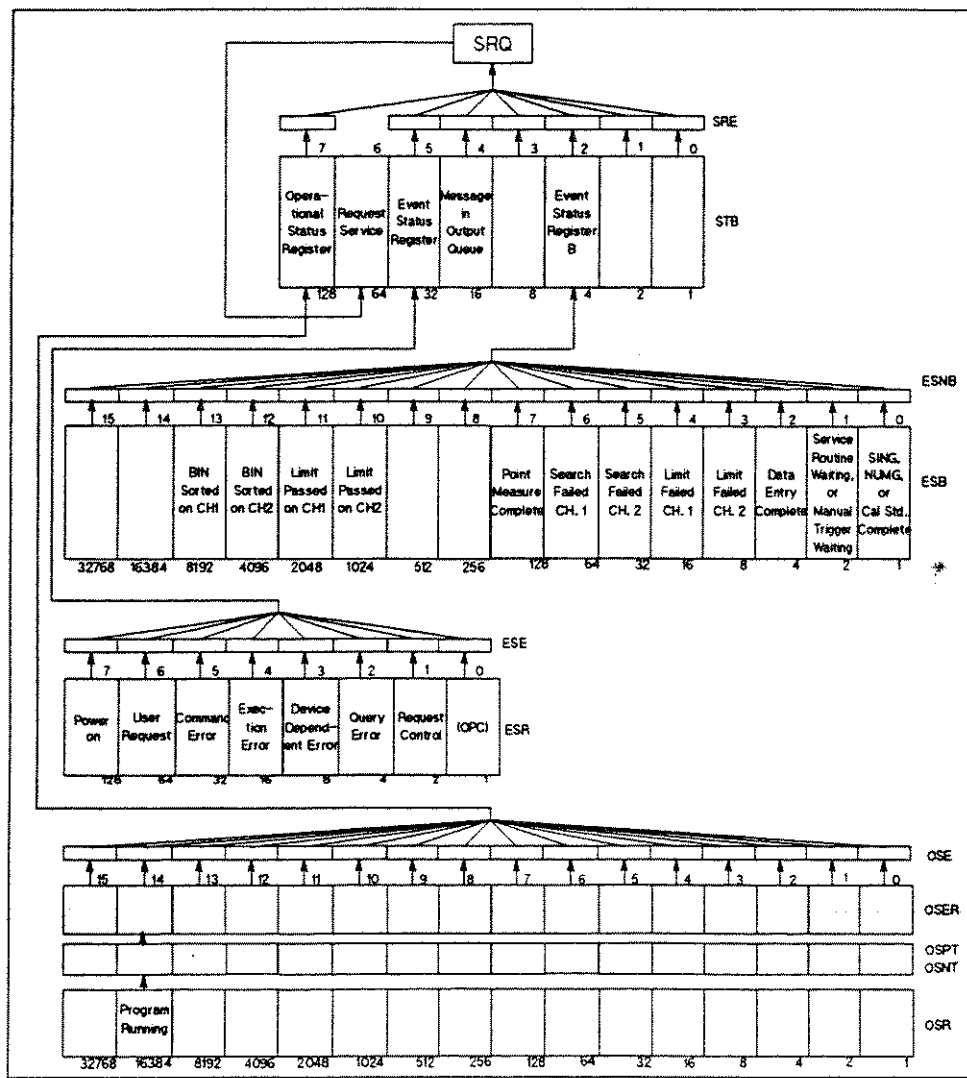

Figure B-1. Status Reporting Structure

The HP 87510A has a status reporting system to report the condition of the instrument. Status bytes consists of 8-bit registers, each bit represents specific instrument conditions. The value of the status byte can be read by using SPOLL(717) statement from an external controller. This command reads value directly from the HP 87510A without being set to remote. So, you can operate front panel keys while a controller is reading the status byte. Contents of the status

byte can also be read by using the *STB? command. Reading the status byte has no effect on the contents of the status byte. Table B-1 shows contents of status byte.

Table B-1. Status Bit Definitions of the Status Byte (STB)

Bit	Name	Description
2	Check event status register B	One of the enabled bits in event status register B has been set.
4	Message in output queue	A command has prepared information to be output, but it has not been read yet.
5	Check event status register	One of the enabled bits in the event status register has been set.
6	Request service	One of the enabled status byte bits is causing an SRQ.
7	Operational status summary bit	One of the enabled bits in the operational status register has been set.

For example, to read the contents of Message in the output queue,

```
10 Stat=SPOLL(717)
20 Stb4=BIT(Stat,4)
30 PRINT Stb4
40 END
```

Figure B-2. Example of Reading Status Byte (1)

or,

```
10 ASSIGN @Hp87510 TO 717
20 OUTPUT @Hp87510;"*STB?"
30 ENTER @Hp87510;Stat
40 Stb4=BIT(Stat,4)
50 PRINT Stb4
60 END
```

Figure B-3. Example of Reading Status Byte (2)

The Event Status Register (ESR), Event Status register B (ESB), and Operational Status Register (OSR) are subordinate to the status byte. Each register is set a bit with condition which is watched by status bit. Status bit is cleared when is read by query or CLES command is executed.

Table B-2. Status Bit Definitions of the Event Status Register (ESR)

Bit	Name	Description
0	Operation complete	A command for which OPC has been enabled, and completed an operation.
1	Request control	The HP 87510A has been commanded to perform an operation that requires control of a peripheral, and needs control of HP-IB.
2	Query error	<ol style="list-style-type: none"> 1. The HP 87510A has been addressed to talk, but there is nothing in the output queue to transmit. 2. Data in the Output Queue has been lost.
3	Device dependent error	An error, other than a command error, a query error, and an execution error has occurred.
4	Execution error	<ol style="list-style-type: none"> 1. A program data element following a header exceeded its input range, or is inconsistent with the HP 87510A's capabilities. 2. A valid program message could not be properly executed due to some instrument condition.
5	Command error	<ol style="list-style-type: none"> 1. An IEEE 488.2 syntax error has been occurred. Possible violations include, a data element violated the HP 87510A listening formats or a data element type is unacceptable to the HP 87510A. 2. A semantic error which indicates that an unrecognized header was received has occurred. Unrecognized headers include incorrect device-specific headers and incorrect or unimplemented IEEE 488.2 common commands. 3. A Group Execute Trigger (GET) was entered into the Input Buffer of a program message.
6	User request	The operator pressed a front panel key or an optional keyboard key or turned the rotary knob.
7	Power on	A power-on sequence has occurred since the last read of the register.

Table B-3. Status Bit Definitions of the Event Status Register B (ESB)

Bit	Name	Description
0	Sweep or group complete, or cal std. complete	A single sweep or group has been completed since the last read of the register. Operates in conjunction with SING or NUMG.
1	Service routine waiting or done, or manual trigger waiting	1. An internal service routine has completed an operation, or is waiting for an operator response. 2. The HP 87510A has set the manual trigger to the point mode and is waiting for a manual trigger.
2	Data entry complete	A terminator key has been pressed.
3	Limit failed, Ch 2	Limit test failed on channel 2.
4	Limit failed, Ch 1	Limit test failed on channel 1.
5	Search failed, Ch 2	A marker search was executed on channel 2, but the target value was not found.
6	Search failed, Ch 1	A marker search was executed on channel 1, but the target value was not found.
7	Point measurement complete ¹	One measurement point of a sweep has been completed.
10	Limit Passed, Ch 2	Limit test passed on channel 2.
11	Limit Passed, Ch 1	Limit test passed on channel 1.
12	BIN Sorted, Ch2	Sorted at specified BIN on channel 2. ²
13	BIN Sorted, Ch1	Sorted at specified BIN on channel 1. ²

¹ This bit is set only when the related bits of both SRE and ESNB are enabled.

In the case of the manual trigger on point mode, HP 87510A accepts the next trigger while current measurement is in progress (up to the number of points). Use bit 1 and bit 7 correctly to synchronize measurement and external triggering. For example, 1) wait until bit 1 is set, 2) trigger, and 3) wait until bit 7 is set.

² BIN is specified by BINESB command

**Table B-4.
Status Bit Definitions of the Operational Status Register (OSR)**

Bit	Name	Description
14	Program running	An HP Instrument BASIC program is running.

Each status register has a register mask which enables generating Service ReQuest (SRQ) with condition of a status bit. For instance, to generate an SRQ when the HP 87510A completes the specified number of sweep, enable ESNB bit 1 which is the mask register for ESB 0 ("SING, NUMG, or Cal Std. Complete") which shows sweep completion and SRE bit 2. This makes a path from ESB bit 0 to an SRQ. This example is listed as a program listing:

```

10 ASSIGN @Hp87510 TO 717
20 !
30 OUTPUT @Hp87510;"CLES" ! Clears status registers
40 OUTPUT @Hp87510;"ESNB 1" ! Enables mask register of "SING. NUMG. or
50 ! ! Cal Std. Complete" of ESB
60 OUTPUT @Hp87510;"*SRE 4" ! Enables mask register of "Event Status
70 ! ! Register B" of STB
80 !
90 ON INTR 7 GOTO End ! Declare SRQ interrupt
100 ENABLE INTR 7;2
100 OUTPUT @Hp87510;"SING" ! Execute single sweep
110 GOTO 110 ! Endless loop
120 !
130 End: ! Exit from loop when sweep is completed
140 END

```

Figure B-4. Example of Generating a Service ReQuest (SRQ)

OSPT, OSNT

OSPT (Operational Status Positive Transition Filter)

Sets the positive transition filter. Setting a bit in OSPT will cause a 0 to 1 transition in the corresponding bit of the associated operational status register (OSR) to cause a 1 to be written in the associated bit of corresponding operational status event register (OSER).

Because only bit 17 of the HP 87510A's OSR is used to show program status, when bit 17 of OSPT is set to 1, starting a program causes a 1 to be written in bit 17 of OSER. (And then a 1 is written in bit 7 of STB.)

OSNT (Operational Status Negative Transition Filter)

Sets the negative transition filter. Setting a bit in the negative transition filter will cause a 1 to 0 transition in the corresponding bit of the associated operational status register to cause a 1 to be written in the associated bit of corresponding operational status event register.

Because only bit 17 of the HP 87510A's OSR the is used to show program status, when bit 17 of OSNT is set to 1, stopping a program causes a 1 to be written in bit 17 of OSER. (And then a 1 is written in bit 7 of STB.)

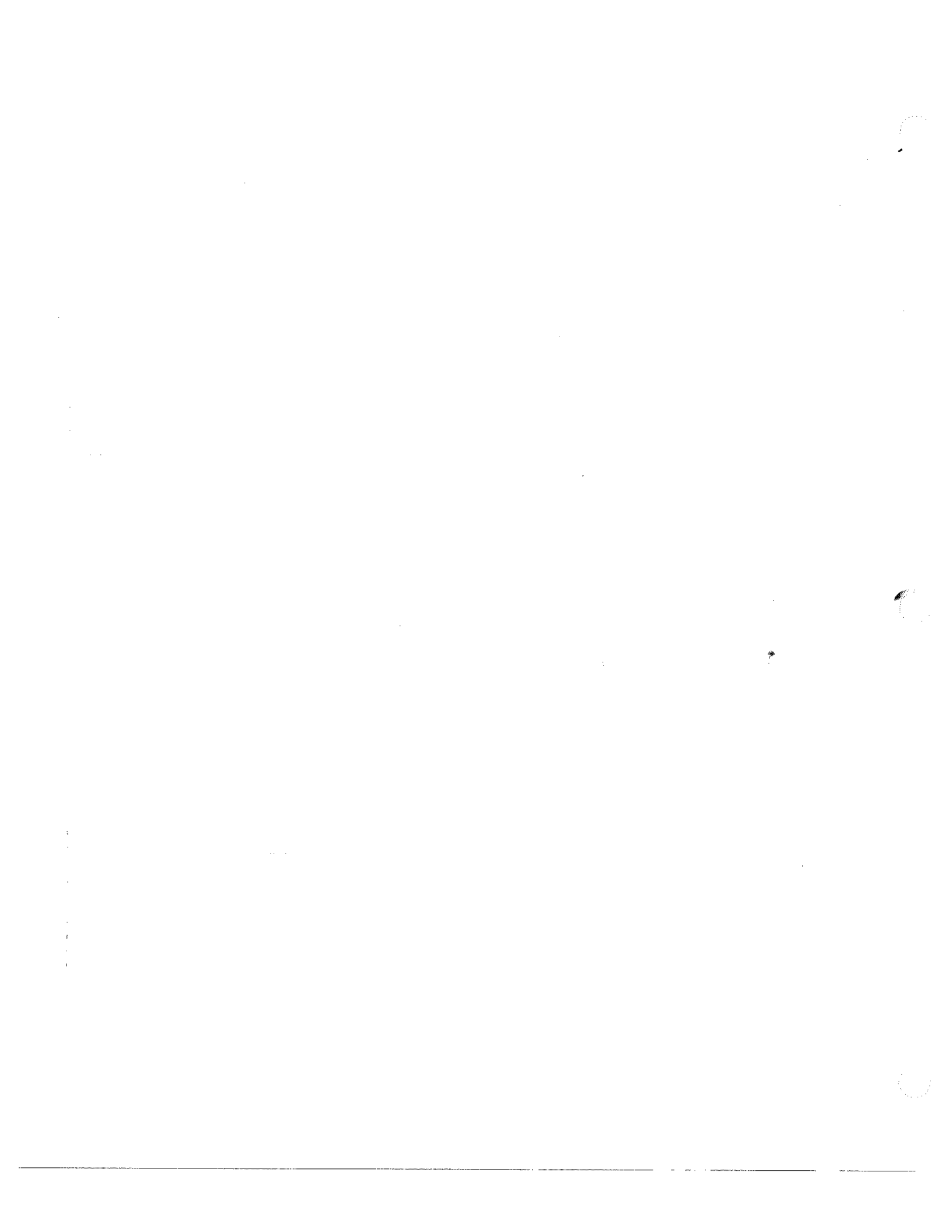

Key Codes

Figure C-1 shows the codes of the front panel keys for using the KEY HP-IB command.

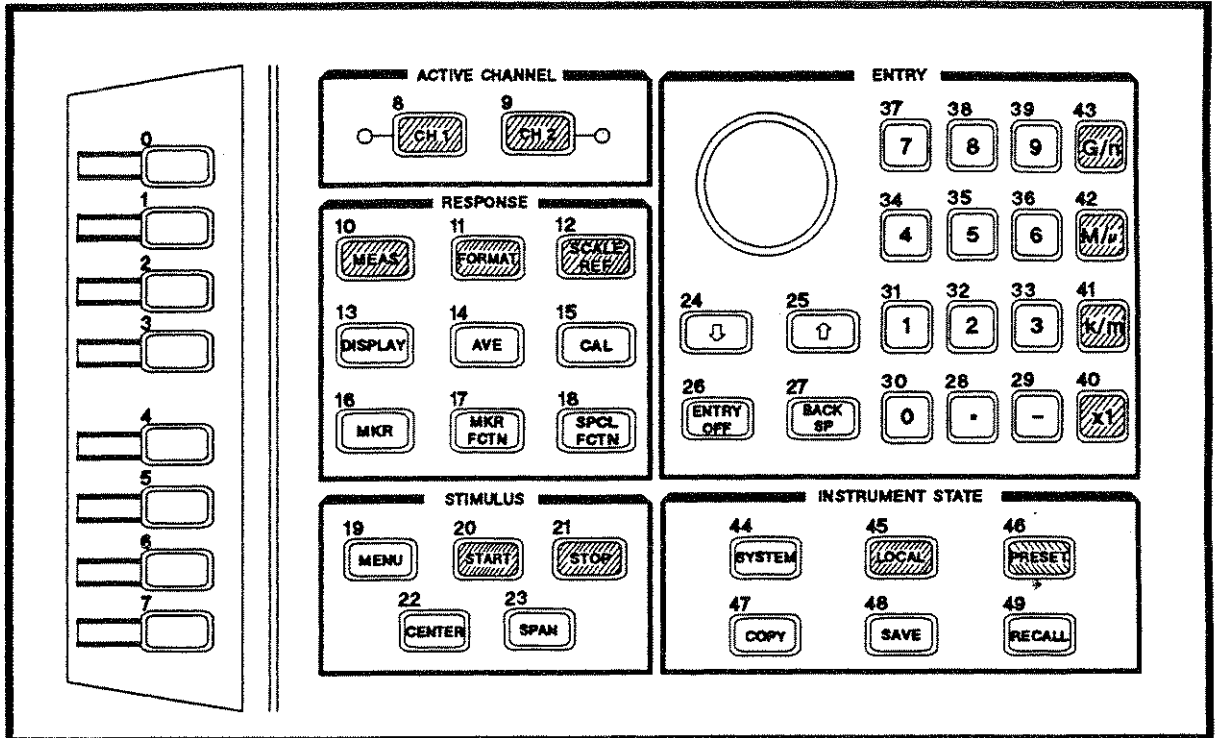

D450C001

Figure C-1. Key Codes

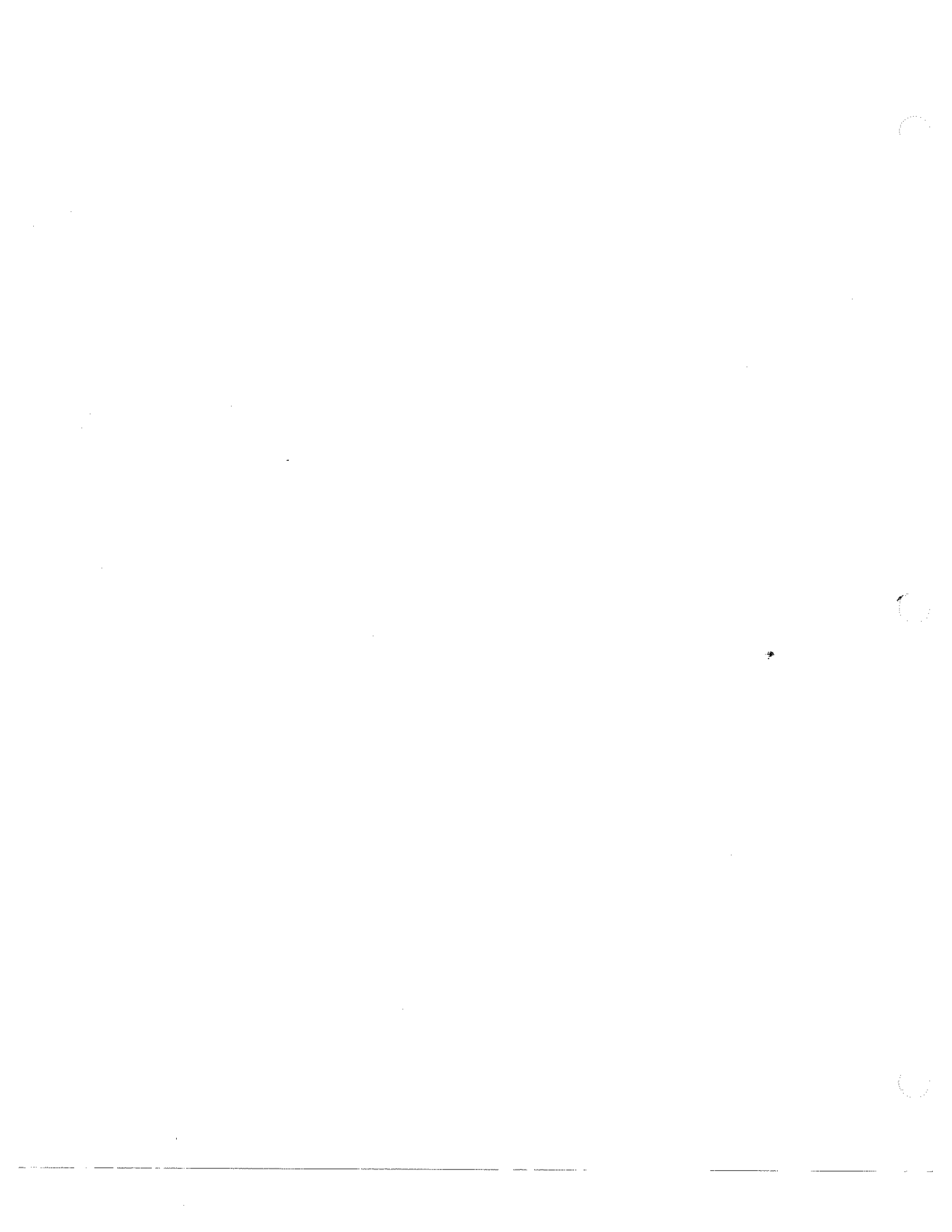

D

Calibration Types and Standard Classes, and Calibration Arrays

Table D-1 lists which standard classes are required for each calibration type. Table D-2 specifies where the calibration coefficients are stored for different calibration types.

Table D-1. Calibration Types and Standard Classes

Class	Response	Response and Isolation	S ₁₁ 1-port
Response:	•		
Response and isolation: Response Isolation		• •	
Reflection: S ₁₁ A (opens) S ₁₁ B (shorts) S ₁₁ C (loads)			• • •

Table D-2. Calibration Array

Array	Response ¹	Response and Isolation ¹	1-port
1	E _T	E _X	E ₁
2		E _T	E ₂
3			E ₃

¹ Meaning of subscript: X=crosstalk; T-transmission tracking.

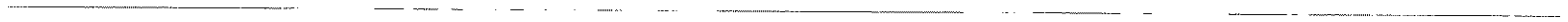

Waveform Analysis Commands

The HP 8751A has several commands for analyzing measurement waveforms. These commands allow you to perform analysis with a single command instead of combining marker functions.

This appendix provides information about these waveform analysis commands. The commands are divided into four groups as follows:

- Waveform analysis setting commands
- Ripple analysis commands
- Maximum/Minimum/Mean search commands
- Filter and Resonator analysis commands

When a query command is sent, the HP 8751A searches, calculates, and then returns the resultant data by HP-IB. Nothing will be displayed on the CRT during this time. This makes possible faster and easier operation than using the marker function in an HP-IB program.

Note

Figures are concept figures to show how the commands work, and they are different from an actual measurement display. Actually, nothing will change on the CRT when a command is executed.

Setting Commands for Waveform Analysis

The following commands specify the analysis range for the previously mentioned waveform analysis commands.

```
ANARANG
ANARFULL
ANAODATA
ANAOMEMO
ANA0CH1
ANA0CH2
THRR
```

ANARANG and ANARFULL

ANARANG sets the stimulus range for the waveform analysis commands. This analysis range is specified independently from the marker search range. When the HP 8751A is turned ON, the default setting for the analysis range is equal to the full stimulus range.

When the analysis range exceeds the stimulus range, the analysis range is reset to match the stimulus range. For example, if the analysis range is set from 80 MHz to 100 MHz when the stimulus range is 75 MHz to 95 MHz, the HP 8751A resets the analysis range to 80 MHz to 95 MHz. If the stimulus setting is modified after the analysis range is set, the HP 8751A resets the analysis range to the full range of the new stimulus range.

ANARFULL sets the waveform analysis range equal to the full stimulus range.

ANAOCH1/ANAOCH2

These commands select the channel to be used by the waveform analysis commands. **ANAOCH1** selects channel 1 and **ANAOCH2** selects channel 2. The channel selected is independent of active channel.

ANAODATA and ANAOMEMO

These commands select the object trace to be used by the waveform analysis commands. **ANAODATA** selects a data trace and **ANAOMEMO** selects a memory trace for waveform analysis.

Note



The target trace (data or memory) can be specified independently for each channel. The **ANAODATA/ANAOMEMO** command is effective for the currently selected channel. So, the **ANAODATA/ANAOMEMO** command should be set after switching channel using the **ANAOCH1/ANAOCH2** command.

THRR

Sets threshold ripple height for waveform analysis commands. Ripple height is defined as difference between local maximum and local minimum. Waveform analysis command searches only greater ripples than threshold value, and others are ignored. Default threshold value is 0.

Ripple Analysis Command

The following commands analyze ripple of trace data and return the resultant data by HP-IB. The effective analysis range for these commands is specified with the **ANARANG** command. The HP 8751A starts ripple analysis when it receives a query.

A sensitivity of ripple search can be set by **THRR** command. For details about **THRR**, refer to "THRR".

RPLPP?
RPLHEI?
RPLRHEI?
RPLLHEI?
RPLENV?
RPLMEA?
RPLVAL?
POLE?

RPLPP?

The RPLPP? command calculates the amplitude between the local maximum and minimum points within a specified range as shown in Figure E-1 and outputs the resultant data by HP-IB. If no ripple is detected, a zero is returned.

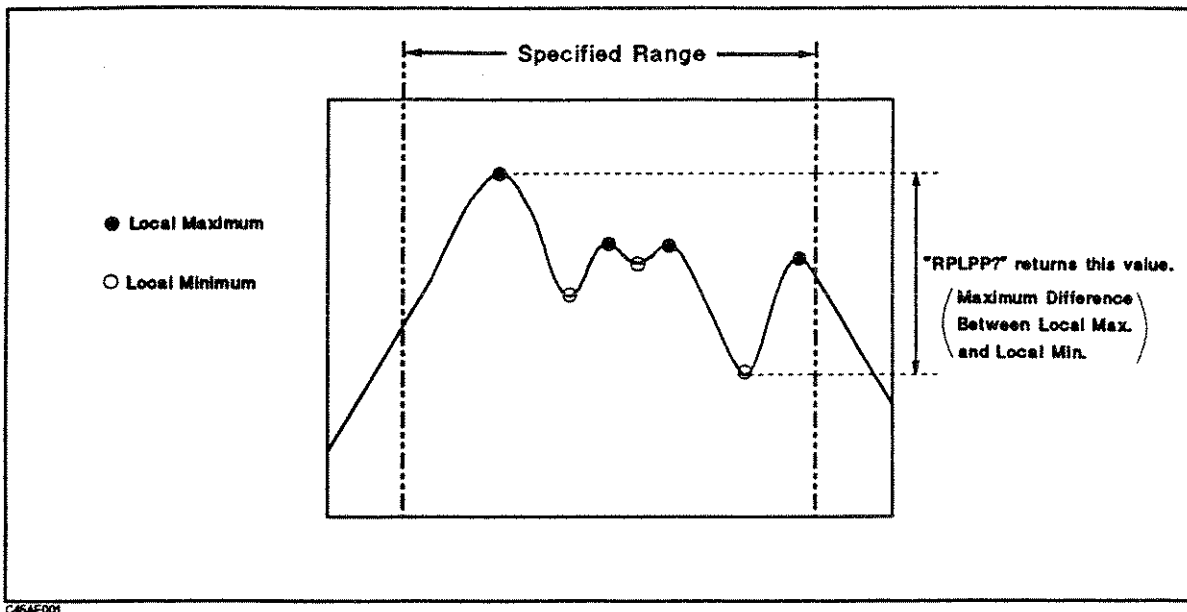

Figure E-1. RPLPP?

```
10 ASSIGN @Hp87510 TO 717          ! When iBASIC is used, *
15                                ! Change 717 to 800.
20 OUTPUT @Hp87510;"ANAOCH1"      ! Select channel 1 for analysis
30 OUTPUT @Hp87510;"ANARANG 69.99E6,70.01E6" ! Set freq. range for analysis.
35                                ! (69.99 MHz through 70.01 MHz)
40 OUTPUT @Hp87510;"ANAO DATA"   ! Select DATA trace for analysis
50 OUTPUT @Hp87510;"RPLPP?"      ! Search for ripple
60 ENTER @Hp87510;Ripple          ! Get ripple value
70 PRINT Ripple;" dB"            ! Print ripple value
80 END
```

Figure E-2. Sample Program for RPLPP

RPLHEI?

The RPLHEI? command searches for the maximum height between all neighboring local maximums and minimums within a specified range, as shown in Figure E-3 and outputs the resultant data by HP-IB. If no ripple is detected, a zero is returned.

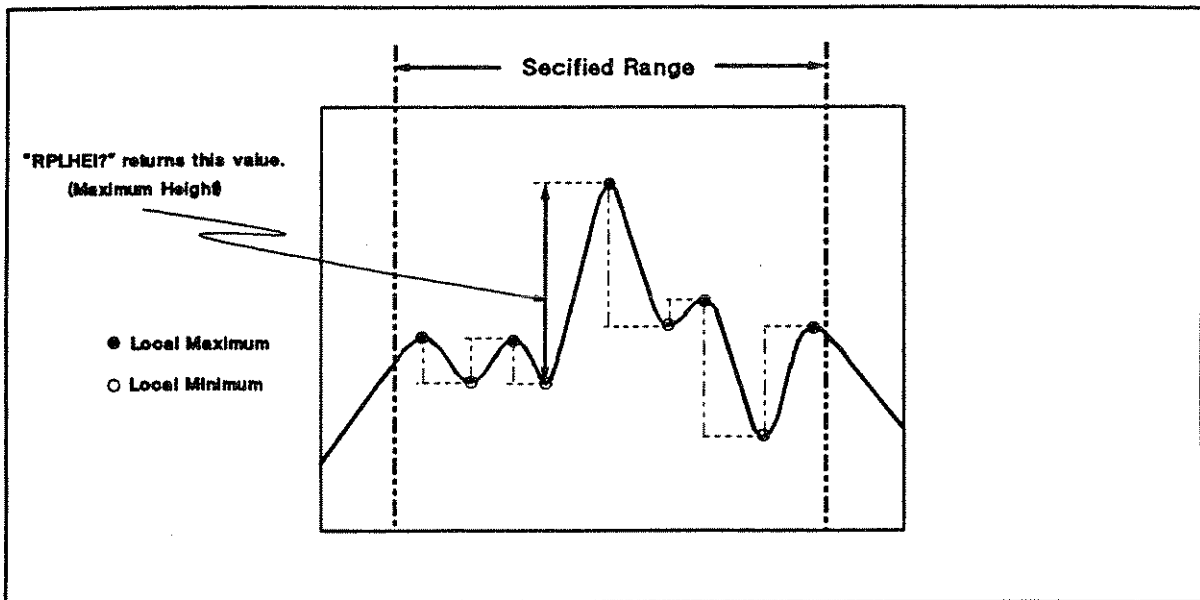

Figure E-3. RPLHEI?

```
10 ASSIGN @Hp87510 TO 717      ! When iBASIC is used, change 717 to, 800
20 OUTPUT @Hp87510;"ANAOCH1"  ! Select channel 1 for analysis
30 OUTPUT @Hp87510;"ANARFULL" ! Range for analysis is equal to
35                             ! the stimulus range.
40 OUTPUT @Hp87510;"ANAO DATA" ! Select DATA trace for analysis
50 OUTPUT @Hp87510;"RPLHEI?"  ! Search for ripple
60 ENTER @Hp87510;Ripple      ! Get ripple value
70 PRINT Ripple;" dB"        ! Print ripple value
80 END
```

Figure E-4. Sample Program for RPLHEI

RPLRHEI? and RPLLHEI?

These commands also search for the maximum height between neighboring local maximums and minimums within a specified range as does the RPLHEI command. But RPLRHEI? searches only for the local minimum to the right from each local maximum point, and RPLLHEI? searches only for the local minimum to the left from each local maximum point as shown in Figure E-5. Both commands return the maximum height by HP-IB. If no ripple is detected, a zero is returned.

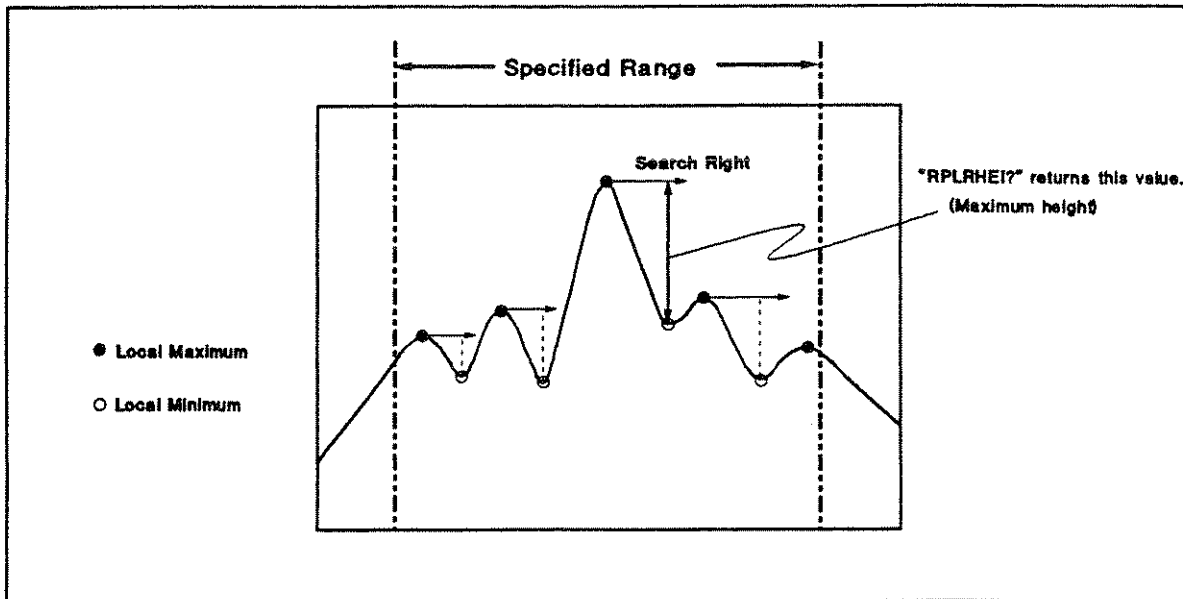

C46AE003

Figure E-5. RPLRHEI?

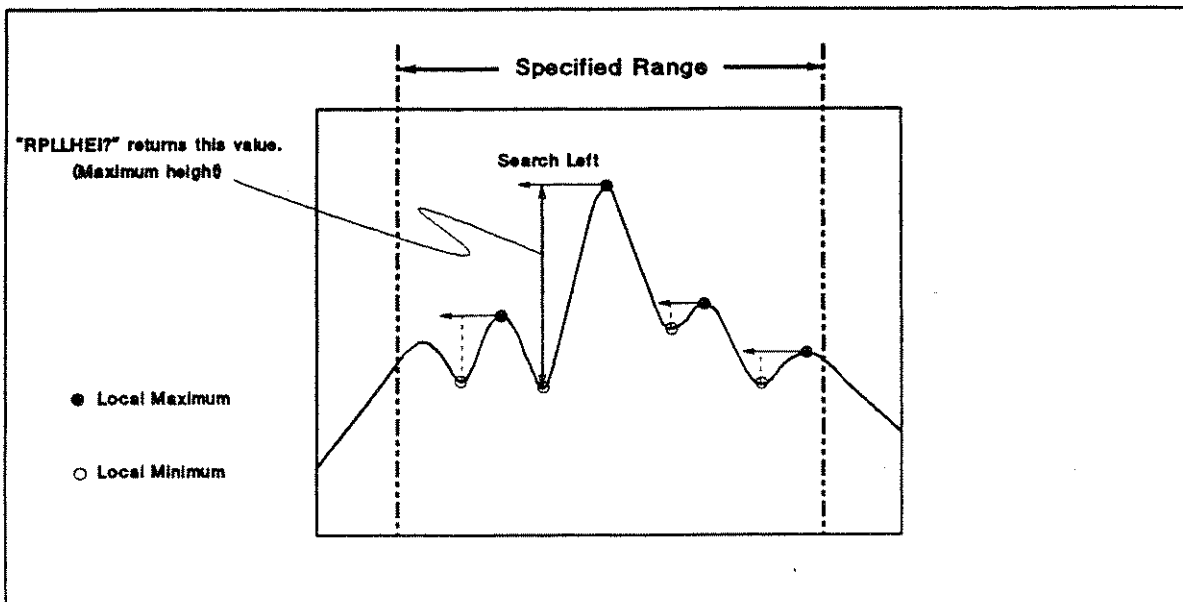

C46AE004

Figure E-6. RPLLHEI?

RPLENV?

This command searches all neighboring peaks and their included valleys for the maximum height, perpendicular from the valley minimum point between neighboring peaks, to the intersection of an imaginary slope line drawn between the neighboring local maximums as shown in Figure E-7, and outputs the resulting maximum envelope value by HP-IB. If no ripple is detected, a zero is returned.

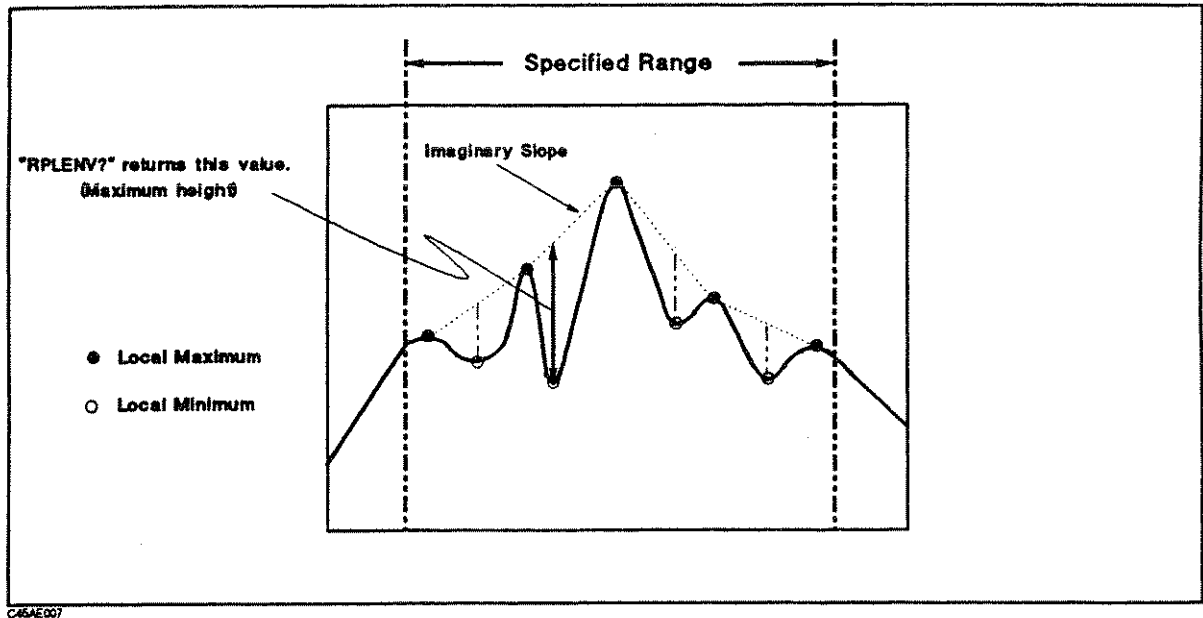

Figure E-7. RPLENV?

RPLMEA?

This command averages all heights between neighboring local maximums and minimums within a specified range as shown in Figure E-8 and outputs the average value by HP-IB. If no ripple is detected, a zero is returned.

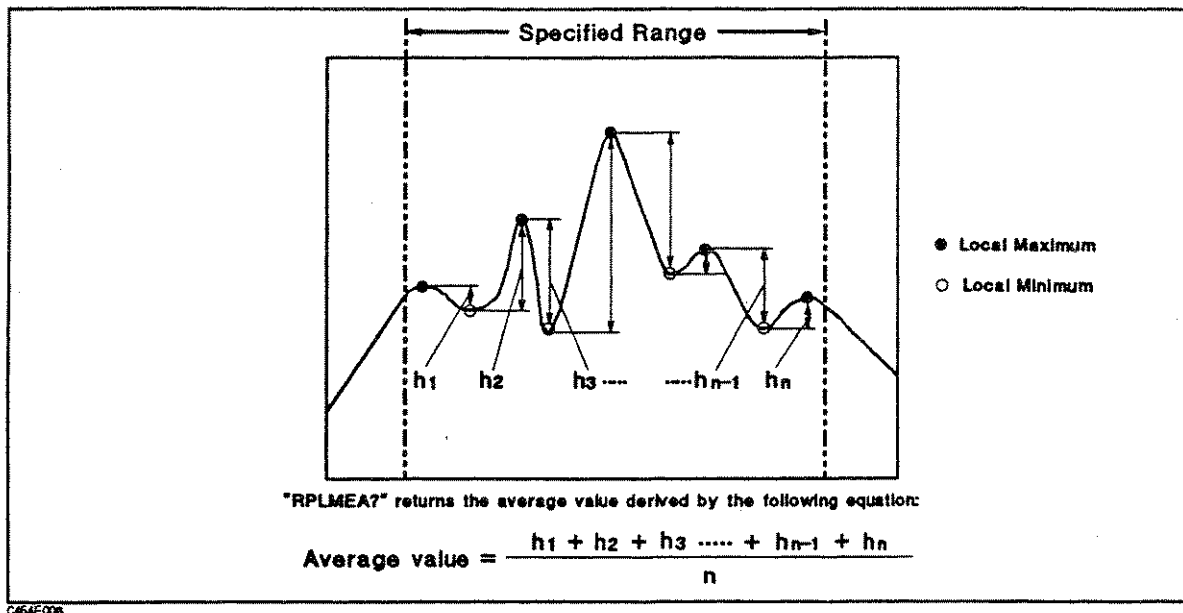

Figure E-8. RPLMEA?

```

110 ASSIGN @Hp87510 TO 717      ! When iBASIC is used, change 717 to 800
120 OUTPUT @Hp87510;"ANAOCH1"  ! Select channel 1 for analysis
130 OUTPUT @Hp87510;"ANARFULL" ! Range for analysis is equal to
135                               ! the stimulus range.
140 OUTPUT @Hp87510;"ANAO DATA" ! Select DATA trace for analysis
150 OUTPUT @Hp87510;"RPLRHEI?" ! Search right for ripple
160 ENTER @Hp87510;Right_ripple ! Get ripple value
170 OUTPUT @Hp87510;"RPLLHEI?" ! Search left for ripple
180 ENTER @Hp87510;Left_ripple  ! Get ripple value
190 OUTPUT @Hp87510;"RPLENV?"  ! Search for "envelope ripple"
200 ENTER @Hp87510;Env_ripple   ! Get envelope value
210 OUTPUT @Hp87510;"RPLMEA?"  ! Search for ripple and average ripple values
220 ENTER @Hp87510;Mean_ripple  ! Get average value
230 PRINT "Right Ripple ";Right_ripple ! Print ripple values
240 PRINT "Left Ripple ";Left_ripple  !
250 PRINT "Env. Ripple ";Env_ripple   !
260 PRINT "Mean Ripple ";Mean_ripple  !
280 END

```

Figure E-9. Sample Program for RPLRHEI, RPLLHEI, RPLENV and RPLMEA

RPLVAL?

The RPLVAL? command returns the maximum total of the differences between the local minimums and the adjacent left-hand and right-hand local maximums within the range specified by the ANARANG command and the stimulus value of the minimum total by the HP-IB bus. Refer to Figure E-10. If the corresponding points are not found, a zero will be returned.

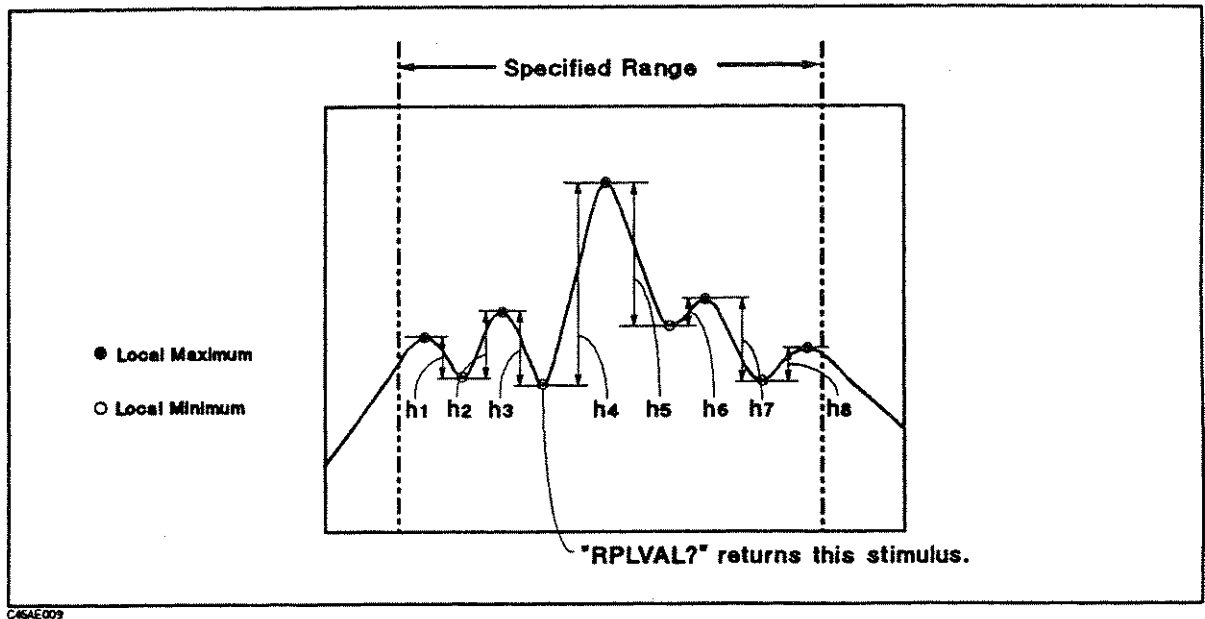

Figure E-10.

POLE?

The POLE? command searches from the maximum value point for the leftward and rightward local minimums which are below the value obtained by subtracting the parameter-specified value from the maximum value, and returns the first qualifying local minimums found with their corresponding stimulus values. Refer to Figure E-11. The command parameter should be a negative value. If such a point is not found, a zero will be returned.

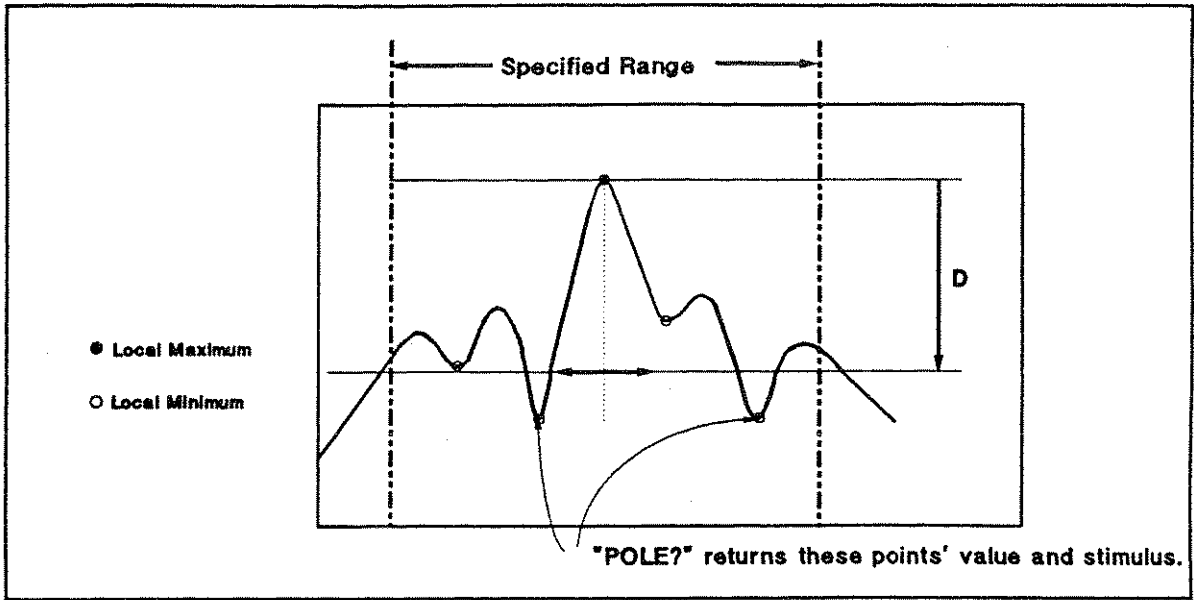

Figure E-11. POLE?

Maximum/Minimum/Mean Value Search Command

The following commands return the maximum, minimum, and mean value of a trace within the range specified by the ANARANG command.

```

OUTPMAX?
OUTPMIN?
OUTPMINMAX?
OUTPMEAN?
PEAK?
NEXPK?
NUMLMAX?
NUMLMIN?
LMAX?
LMIN?
TARR?
TARL?

```

OUTPMAX?/OUTPMIN?/OUTPMINMAX?

These commands search for a maximum/minimum/mean value within a specified range and returns it with its corresponding stimulus value by HP-IB. OUTPMAX? returns the maximum value and OUTPMIN? returns the minimum value. OUTPMINMAX? returns both the maximum and minimum values.

OUTPMEAN?

OUTPMEAN? returns the mean value within a specified range by HP-IB.

PEAK?

The **PEAK?** command returns the maximum local maximum within the specified range with its corresponding stimulus value. If there are two or more maximum local maximums, the minimum stimulus value is returned. The HP 87510A records the maximum local maximum and its stimulus value. If such a local maximum is not found, a zero will be returned.

NEXPK?

The **NEXPK?** command returns the maximum local maximum (within the specified range) having a value less than the value recorded by the HP 87510A. It also returns the corresponding stimulus value. If two or more such local maximums are found, this command returns the local maximum having a stimulus value larger than the stimulus value recorded by the HP 87510A. If such a local maximum is not found, a zero will be returned.

NUMLMAX?

The **NUMLMAX?** command returns the number of local maximums within the specified range.

NUMLMIN?

The **NUMLMIN?** command returns the number of local minimums within the specified range.

LMAX?

The **LMAX?** command returns the nth local maximum counted from the left end of the specified range. n is a command parameter. If such a local maximum is not found, 3.40282347E+38 will be returned.

LMIN?

The **LMIN?** command returns the nth local minimum counted from the left end of the specified range. n is a command parameter. If such a local minimum is not found, 3.40282347E+38 will be returned.

TARR?

The **TARR?** command searches for the point having the parameter-specified value rightward from the left end of the specified range. If it is found, the **TARR?** command returns it and its corresponding stimulus value. If the point is not found, a zero will be returned.

TARL?

The **TARL?** command searches for the point having the parameter-specified value leftward from the right end of the specified range. If it is found, the **TARL?** command returns it and its corresponding stimulus value. If such a point is not found, a zero will be returned.

Filter and Resonator Analysis Command

The following commands are device related. They are easy to use for specific device analysis because they will output many parameters with only a single command.

```
OUTPFILT? value[suffix]
OUTPFIL?
OUTPCFIL?
OUTPRESO?
OUTPRESR?
OUTPRESF?
```

OUTPFILT? *value[*suffix*]*

OUTPFILT? returns filter specific parameters, insertion loss, BW(bandwidth), f_{cent} , Q, $\Delta L.F$ and $\Delta R.F$ within the range specified by the ANARANG command.

This command has parameter which sets the offset of x dB to the maximum peak value to determine the cutoff point. For example, use “-3dB” for the parameter value of OUTPFILT? command to determine the cutoff point to 3 dB below the maximum peak.

Figure E-12 shows a typical example of a bandpass filter measurement trace. The insertion loss is the absolute value of the difference of the maximum within a specified range and 0 dB. BW is the stimulus width between two cutoff points (f_1 and f_2) and the center point of two cutoff points are given as f_{cent} . Q is calculated as:

$$Q = \frac{\sqrt{f_1 \times f_2}}{BW}$$

$\Delta L.F$ is the stimulus difference between the left x dB cutoff point and the center point of a specified range. Similarly, $\Delta R.F$ is the difference between the right cutoff point and the center of a specified range.

Zeros will be returned for all parameters when two x dB points can not be found.

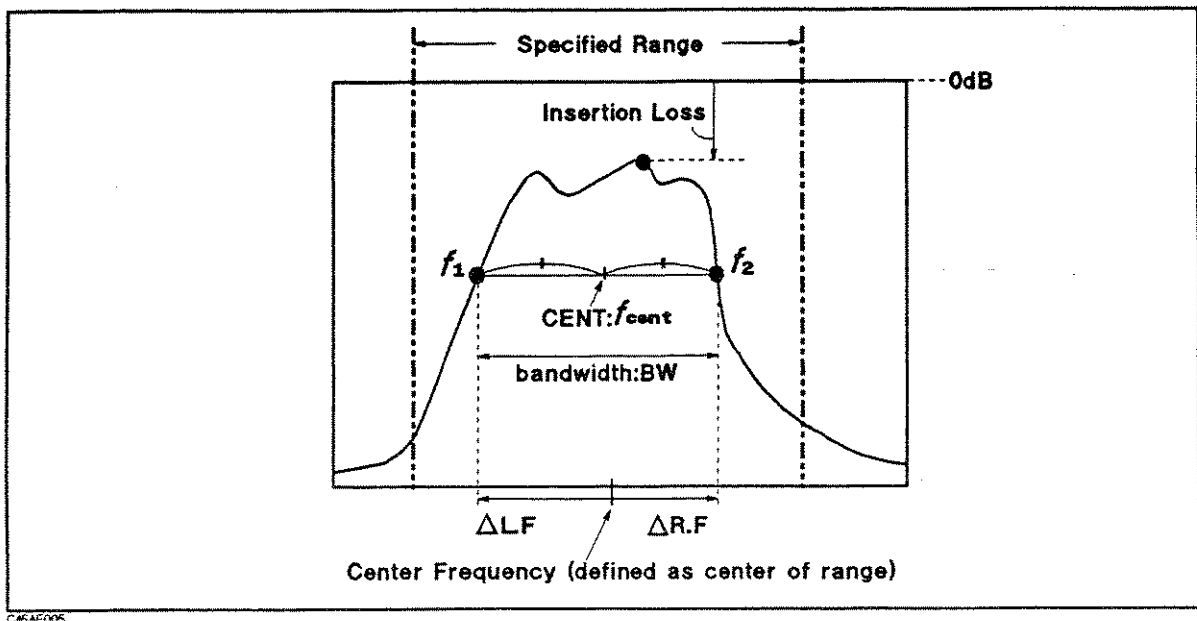

Figure E-12. Output Filter Parameters Example

```

100 ASSIGN @Hp87510 TO 717          ! If iBASIC is used,
105                                ! Change 717 to 800.
110 OUTPUT @Hp87510;"PRES"         ! Preset the HP 8751A.
120 OUTPUT @Hp87510;"HOLD"         ! Sweep hold
130 OUTPUT @Hp87510;"DISAALLB"     ! Display allocation is ALL BASIC
140 OUTPUT @Hp87510;"CENT 70E6;SPAN 100E3" ! CENTER 70 MHz, SPAN 100 kHz
150 OUTPUT @Hp87510;"AR"           ! Measure AR
160 OUTPUT @Hp87510;"ANAOCH1"      ! Select CHANNEL 1 to be used
170 OUTPUT @Hp87510;"ANARANG 69.95E6,70.05E6" ! Analysis range is between
175                                ! 69.95 MHz and 70.05 MHz
176                                ! by the analysis command.
180 OUTPUT @Hp87510;"ANAOCH1"      ! Select DATA TRACE to be used
185                                ! by the analysis command.
190 OUTPUT @Hp87510;"SING"         ! Trigger sweep
200 OUTPUT @Hp87510;"OUTPFILT? -3" ! Query -3 dB bandwidth and
                                   ! other filter parameters.
210 ENTER @Hp87510;I1,Bw,Fc,Q,Lf,Rf ! Get filter parameters
220 PRINT "INSERTION LOSS ",I1;"dB" ! Print parameters
230 PRINT "BANDWIDTH      ",Bw/1000;"kHz"
240 PRINT "CENTER FREQUENCY",Fc/1.E+6;"MHz"
250 PRINT "Q FACTOR      ",Q
260 PRINT "LEFT FREQ.    ",Lf/1000;"kHz"
270 PRINT "RIGHT FREQ.   ",Rf/1000;"kHz"
280 END

```

Figure E-13. Sample Program for OUTPFILT

OUTPXFIL?

The OUTPXFIL? command returns the parameters output by the OUTPFILT? command, insertion loss, BW (bandwidth), fcent (frequency center), Q, L.F, R.F, pass band ripple, L.F2 and R.F2 of two points which are X2 dB below the maximum peak, blocking level, spurious level, and POLE? command result (local minimum (left) and its stimulus and local minimum (right) and its stimulus). The OUTPXFIL? command makes an analysis within the range specified by the ANARANG command and returns the result via the HP-IB.

The returned insertion loss, BW, Q, fcent, L.F, and R.F are the same as those of the OUTPFILT? command. For other parameters, refer to Figure E-12.

The pass band ripple is the maximum difference between a local maximum and minimum within the parameter-specified range, f_1 to f_2 . L.F2 and R.F2 indicate the differences between the left and right cutoff points and the center point of a specified range like L.F and R.F. The blocking level is the difference between the maximum value to the left of f_1 and the maximum value within the specified range. The spurious level is the difference between the maximum value to the right of f_2 and the maximum value within the specified range.

The OUTPXFIL? command uses the third command parameter D to return the same result (local minimum (left) and its stimulus and local minimum (right) and its stimulus) as that of the POLE? command. For more information on the POLE? command, see "POLE?".

If two cutoff points which are xdB below the maximum peak are not found, zeros will be returned for all parameters.

If two cutoff points which are X2 dB below the maximum value are not found, zeroes will be returned for L.F2 and R.F2.

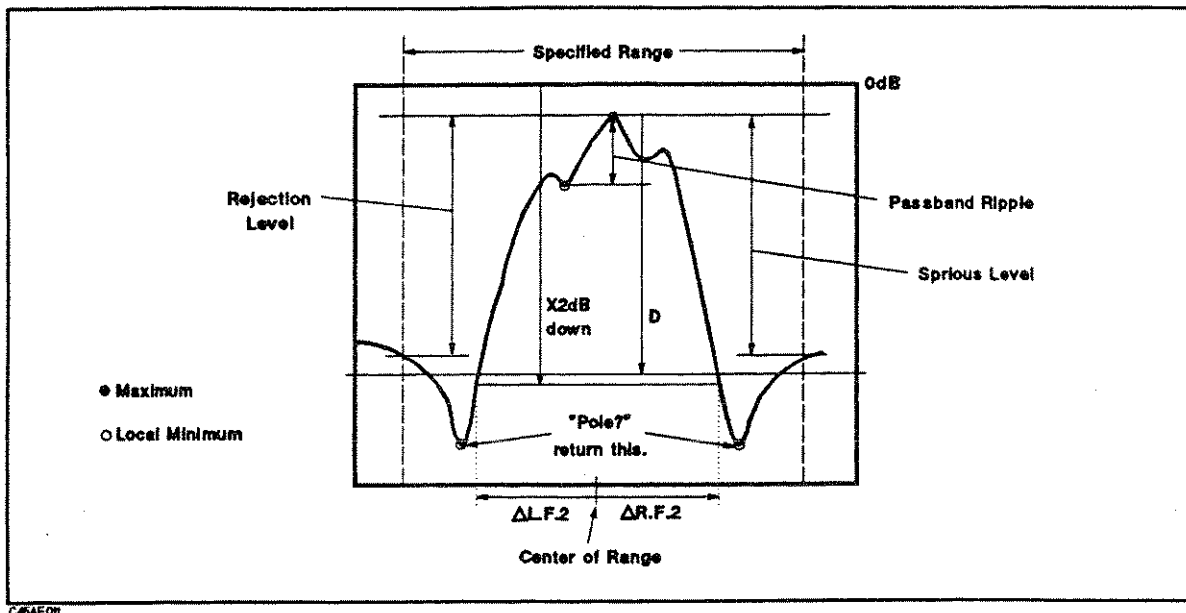

Figure E-14. OUTPXFIL?

OUTPCFIL?

The OUTPCFIL? command returns an insertion loss, point on fc, BW, frequency center, Q, L.F, R.F, pass band ripple, L.F2 and R.F2 of two points which are X2 dB below the maximum peak, blocking level, spurious level, and POLE? command result (local minimum (left) and its stimulus and local minimum (right) and its stimulus). Refer to Figure E-18. The insertion loss is the absolute value of the difference between the maximum value within the specified range and 0 dB. The point on fc is the point on the nominal frequency given as a command parameter. BW is the stimulus width between two cutoff points which are X1 dB below the point on fc. The center frequency (fcent) is the stimulus value of the center of two cutoff points (f₁ and f₂). Q is calculated using the values of BW, f₁, and f₂.

L.F is the stimulus width from fc to f₁. R.F is the stimulus width from fc to f₂. The pass band ripple is the maximum difference between a local maximum and local minimum between f₁ and f₂.

L.F2 and R.F2 are stimulus widths between fc and the left and right cutoff points which are X2 dB below the point on fc.

The blocking level, spurious level, and POLE? command output result are the same as those of the OUTPXFIL? command.

The OUTPCFIL? command uses the fourth command parameter D to return the same result (local minimum (left) and its stimulus and local minimum (right) and its stimulus) as that of the POLE? command.

If two cutoff points which are xdB below the point on fc are not found, zeros will be returned. If two points which are x2 dB below the point on fc are not found, zeros will be returned for L.F2 and R.F2.

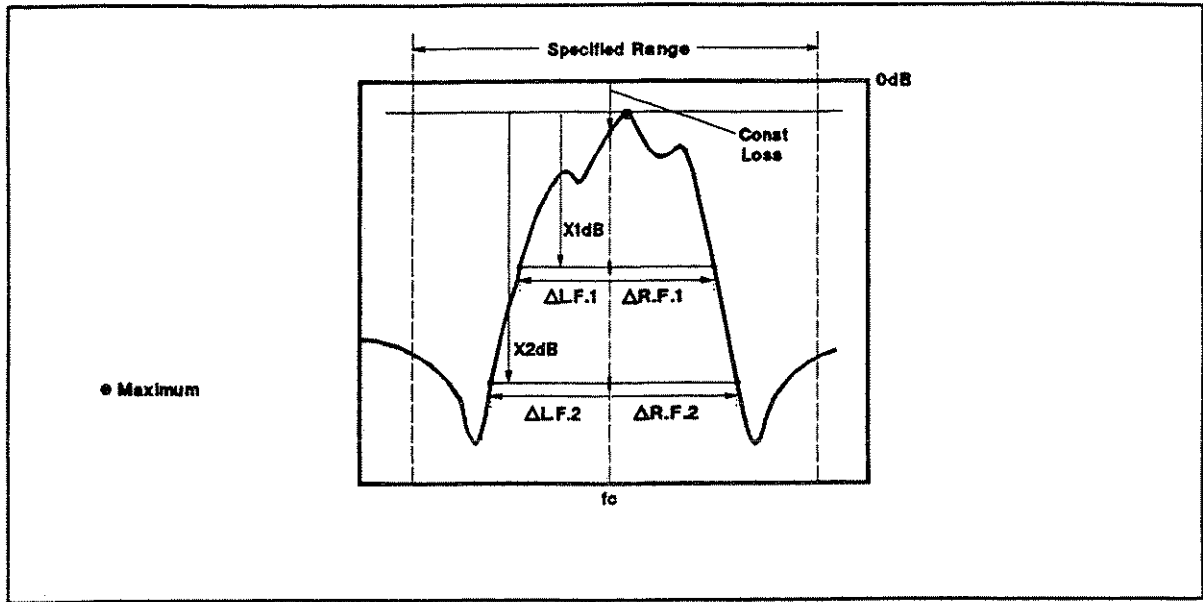

Figure E-15. OUTPCFIL?

OUTPRESO?

OUTPRESO? returns resonator specific parameters, the resonant frequency(f_r) and the anti-resonant frequency(f_a) within a specified range, and the magnitude values(G_r , G_a). (Data format: G_r , f_r , G_a , f_a)

Figure E-16 shows a typical example of an crystal resonator measurement trace. When the OUTPRESO? command is sent, the HP 8751A searches for the 0° phase point, from the left to end of the specified range. The HP 8751A regards the first point found as the resonant point and the second point found as the anti-resonant point and returns the stimulus and magnitude data by HP-IB.

If there are three or more 0° points within a specified range, the HP 8751A returns data on the first two points found. If there is only one 0° point within a specified range, the HP 8751A considers this point to be the resonant point and returns zeros for G_a and f_a . If there is no 0° phase point within a specified range, the HP 8751A will return zeros for all parameters.

This command is available only when in the LOG MAG & Phase format. So, the ANAODATA, ANAOMEMO commands are disregarded. If the format is not "LOG MAG & Phase", the HP 8751A will return zeros for all parameters.

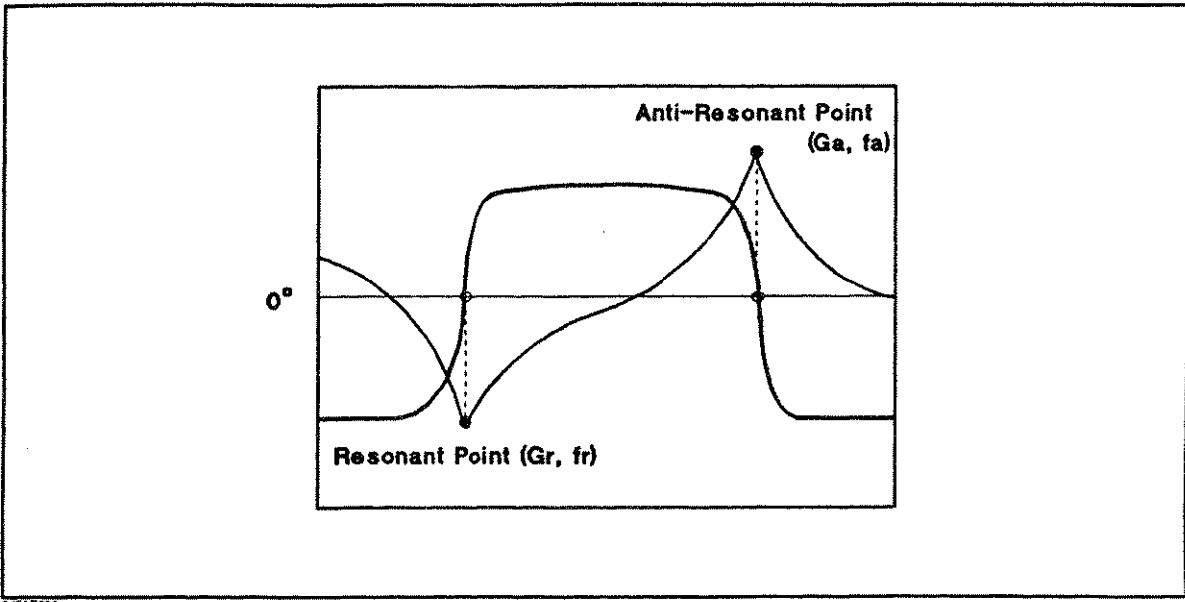

Figure E-16. OUTPRESO?

```

100 ASSIGN @Hp87510 TO 800           ! If iBASIC is used,
115                                 ! Change 717 to 800.
110 ASSIGN @Hp87510a TO 800;FORMAT OFF ! Path for ENTER statement
120 OUTPUT @Hp87510;"";HOLD"         ! Sweep hold
130 OUTPUT @Hp87510;"";DISAALLB"     ! Display allocation is ALL BASIC
140 OUTPUT @Hp87510;"ANA0CH1"       ! Select CHANNEL 1 to be used by
150 OUTPUT @Hp87510;"ANARFULL"      ! Analysis range is full
155                                 ! the analysis command.
160 OUTPUT @Hp87510;"ANA0DATA"      ! Select DATA TRACE to be used
165                                 ! by the analysis command.
170 OUTPUT @Hp87510;"FORM3"         ! Set format to IEEE 64
180 OUTPUT @Hp87510;"OUTPRESO?"     ! Query Res/Ant-res. point.
190 ENTER @Hp87510 USING "#,8A";A$   ! Enter header
200 ENTER @Hp87510a;Zr,Fr,Za,Fa     ! Get result
210 ENTER @Hp87510 USING "#,1A";B$   ! Enter tail
220 PRINT "RES POINT ",Zr;"dB"       ! Print parameters
230 PRINT "RES F ",Fr/1.E+6;"MHz"
240 PRINT "ANT.R POINT ",Za
250 PRINT "ANT.R FREQ. ",Fa/1.E+6;"MHz"
260 END

```

Figure E-17. Sample Program for OUTPRESO

OUTPRESR?

The OUTPRESR? command analyzes the ripple of a resonator which has the characteristics shown in Figure E-19.

When the OUTPRESR? command is issued, the HP 87510A searches for the 0° phase point from the left end of the specified range. The HP 87510A regards the first found point as the resonant point and the second found point as the anti-resonant point. Then, it searches for and returns the following parameters by the HP-IB:

- Gain and stimulus value of the resonant point
- Gain and stimulus value of the anti-resonant point
- Maximum value of the difference between the local maximum and the adjacent left-hand local minimum which are at left of the resonant point
- Maximum value of the difference between the local maximum and the maximum value of the adjacent right-hand local minimum which are between the resonant and antiresonant points
- Maximum value of difference between the local maximum and the maximum value of the adjacent left-hand local minimum which are at the right of the resonant point

If there are three or more phase 0° points within the specified range, the HP 87510A returns the values of first two points found. If there is only one phase 0° point, the HP87510A regards the first found point as the resonant point and returns the stimulus and amplitude values and returns a zero for the anti-resonant parameter. If there is no phase 0° point within the range, zeros will be returned for all parameters.

If Z-conversion was made previously, the above values are returned as impedance values.

This command is available only in the LOG MAG & Phase format. Therefore, the ANAODATA and ANAOMEMO commands are ignored. If the format is not "LOG MAG & Phase," the HP 87510A will return zeros for all parameters.

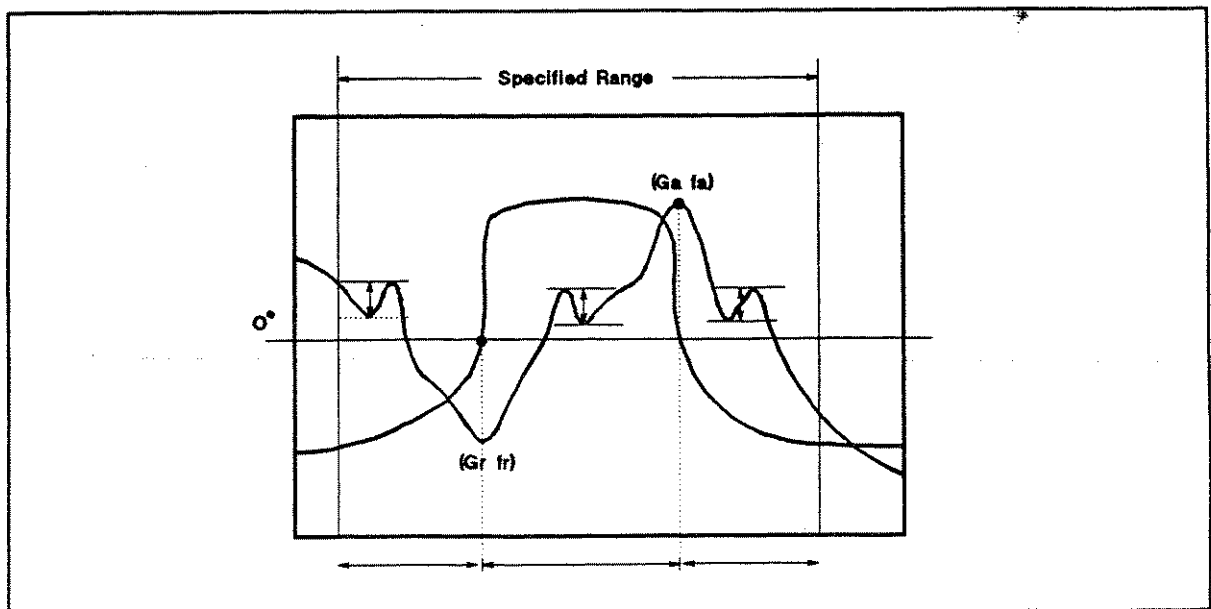

Figure E-18. OUTPRESR?

OUTPRESF?

OUTPRESF? searches maximum local-maximum (f_s) and minimum local-minimum (f_p) within specified range, then, searches x_1 dB below points for both side from f_s and x_2 dB above points for both side from f_p . The first point founded on the left-hand side of f_s is f_{s1} , and right-hand is f_{s2} . In a similar way, f_{p1} is first point found on the left-hand side of f_p , and f_{p2} is right-hand point. See Figure E-19.

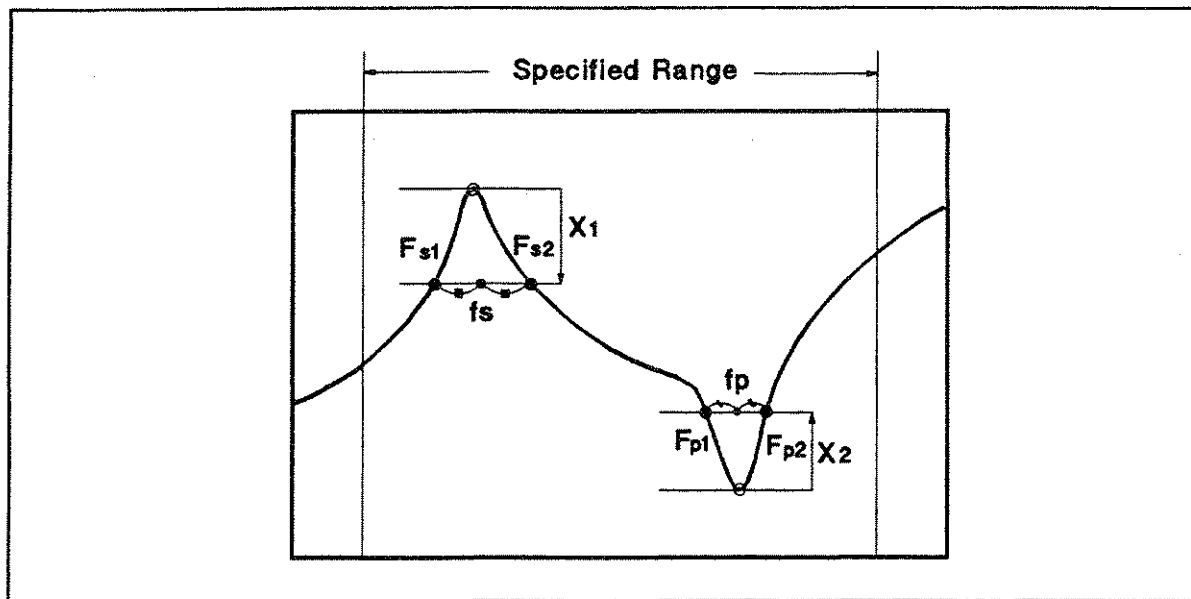

Figure E-19. OUTPRESF?

Equivalent Circuit Analysis Commands

The following commands make an equivalent circuit analysis for the measurement data and return the analysis result. The equivalent circuit analysis is made within the range specified by the ANARANG command. Following commands are only available when the polar format and admittance conversion is selected.

EQUCPARA?

The EQUCPARA? command makes a 4-device equivalent circuit analysis for the crystal resonator and returns equivalent circuit constants. The EQUCPARA? regards the following circuits as equivalent circuits:

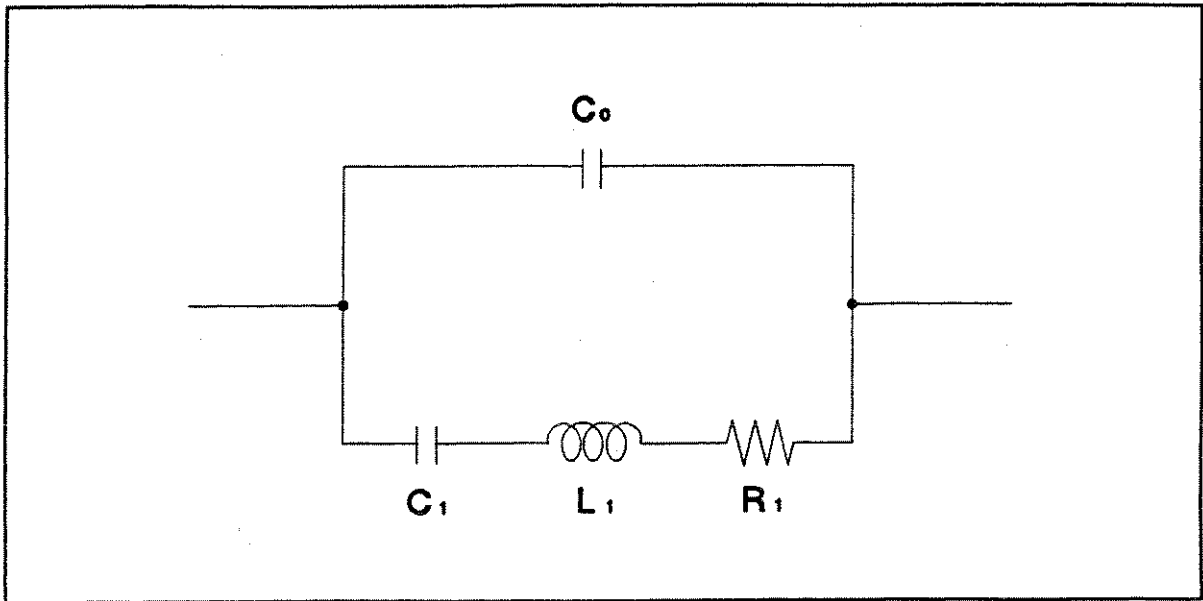

Figure E-20. Four-Device Equivalent Circuit for Crystal Resonator

Where,

- C_0 : Parallel capacity
- C_1 : Motional capacity
- L_1 : Motional inductance
- R_1 : Motional resistance

The EQUCPARA? command obtains the above constants in the following procedure:

1. Obtains the admittance characteristic circle diagram.
2. Obtains the susceptance (Bfs) and its frequency (fs) at the maximum conductance (Gmax) point.
3. Obtains frequencies f_1 and f_2 ($f_1 < f_2$) of two points where the conductance is half the maximum conductance (Gmax).
4. Assumes that the frequency at which the phase becomes 0° near the parallel resonance frequency is f_a .
5. Assumes that the frequency at which the phase becomes 0° near the series resonance frequency is f_r .
6. Calculates the constants using the above values and the following equations:

$$R_1 = \frac{1}{G_{max}}$$

$$L_1 = \left| \frac{Q \times R_1}{2\pi f_s} \right|$$

$$C_1 = \frac{1}{QR_1 \times 2\pi f_s}$$

$$C_0 = \left(\frac{f_r^2}{f_a^2 - f_r^2} \right)$$

Where,

$$Q = \left| \frac{f_2}{f_2 - f_1} \right|$$

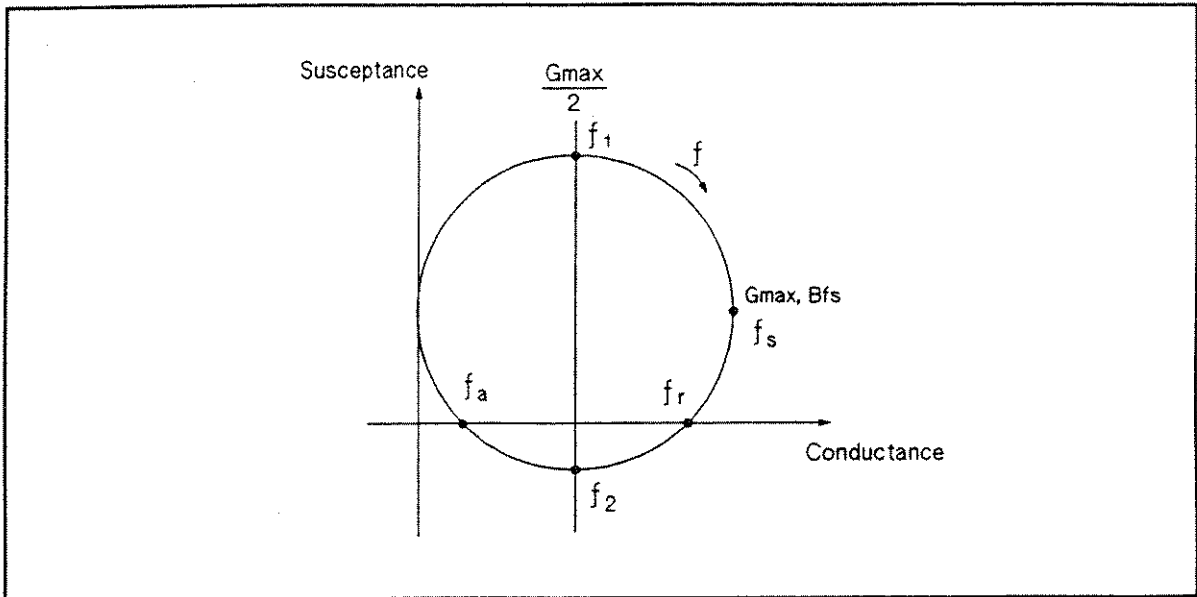

Figure E-21. Admittance Characteristic Chart

If there are no f_r and f_a points on the admittance chart, C_0 is calculated using the following equation:

$$C_0 = \frac{B_{fs}}{2\pi f_s}$$

EQUCPARS?

The EQUCPARS? command returns f_s , f_a , f_r , f_1 , and f_2 in addition to C_0 , C_1 , L_1 , and R_1 which are returned by the EQCUPARA? command. For more information on parameters, see "EQCUPARA?".



HP-IB EXECUTE Commands

Execute Command and HP-IB Command

HP Instrument BASIC of the HP 87510A has an EXECUTE command which can execute HP-IB commands faster than in the ordinary way, for example, using the OUTPUT statement of HP BASIC and Instrument BASIC. EXECUTE command can execute the following HP-IB commands:

Available HP-IB Commands for EXECUTE

ANAOCH1	OUTPMAX?	LMAX?
ANAOCH1	OUTPMEAN?	LMIN?
ANAOCH2	OUTPMINMAX?	RPLVAL?
ANAODATA	OUTPFILT?	OUTPXFIL?
ANAOMEMO	OUTPRESO?	OUTPCFIL?
ANARANG	EQUCPARA?	OUTPRESR?
ANARFULL	EQUCPARS?	OUTPDATAT?
RPLPP?	POLE?	OUTPMEMOT?
RPLHEI?	PEAK?	THRR
RPLRHEI?	NEXP?	SING
RPLLHEI?	TARR?	OUTPDATTP?
RPLENV?	TARL?	OUTPMEMTP?
RPLMEA?	NUMLMAX?	INPUDATTP
OUTPMIN?	NUMLMIN?	INPUMEMTP

For details about EXECUTE, refer to Using the HP Instrument BASIC.

EXECUTE Specific Command

The following HP-IB commands give different result, when used with the EXECUTE command and than when used with the OUTPUT statement.

SING

When executing the SING command, which makes a single sweep, using the EXECUTE command, Instrument BASIC waits before proceeding to the next program-line until completion of the sweep. If SING is executed by OUTPUT, Instrument BASIC executes the next program line, and the program should be designed to the time by the controller by the using sweep end detection technique. By using EXECUTE for SING, above technique is not necessary.

EXECUTE Unique Commands

Following HP-IB Commands are only available for the EXECUTE command. You can not execute them using the OUTPUT statement. The effective channel for these commands are dependent on the setting of ANAOCH1 and ANAOCH2. For details about ANAOCH1 and ANAOCH2, refer to "ANAPOCH1/ANAPOCH2" in Appendix E.

- INPUDATTP
- INPUMEMTP
- OUTPDATTP?
- OUTPMEMTP?

INPUDATTP

Enters data to the nth point of a data trace. Command parameters; data point number, real and imaginary part of input data, are passed to the HP 87510A by using a register. Data point number is set to register 0, real part of input data is set to register 1, and imaginary part of input data is set to register 3.

INPUMEMTP

Enters data to the nth point of a memory trace. Command parameters are data point number, real and imaginary part of input data. Data point number is set to register 0, real part of input data is set to register 1, and imaginary part of input data is set to register 3.

OUTPDATTP?

Outputs the data-trace data for the specified point. Command parameter, point number of data trace, is set to register 0. Query returns real part of specified point to register 0 and imaginary part of specified point to register 1.

OUTPMEMTP?

Outputs the memory data at a specified point. Command parameter, point number of data trace, is set to register 0. Query returns real part of specified point to register 0 and imaginary part of specified point to register 1.

One-Point Correction

HP 87510A has a one point correction function, which corrects each measurement point using a coefficient constant. There are two ways for one-point correction. One uses 1 coefficient, and another uses 3 coefficients.

1 Coefficient Command

This correction command corrects measured data on each point using the following equation:

$$\text{CorrectedData} = \frac{\text{MeasuredData}}{\text{Coefficient1}} \quad (\text{G.1})$$

This equation is the same as correction equation used for frequency response calibration. In this case, coefficient 1 is an error term, transmission tracking (E_1).

HP-IB Command

The following HP-IB commands are used to execute this correction:

INPU DATM1 *real, imaginary*

This command sets coefficient 1.

DATAMTHRU

Calculates measured data by using equation G.1.

3-Coefficient Command

This correction command corrects measured data on each point by using following equation:

$$\text{CorrectedData} = \frac{\text{MeasuredData} - \text{Coefficient2}}{\text{Coefficient3} + \text{Coefficient4}(\text{MeasuredData} - \text{Coefficient2})} \quad (\text{G.2})$$

This equation is the same as the correction equation used for a 3-term calibration. In this case, coefficient 1 is E_1 , coefficient 2 is E_2 , and coefficient 3 is E_3 .

HP-IB Command

The following HP-IB commands are used to execute this correction:

INPUDATM2 *real,imaginary*

This command sets coefficient 2.

INPUDATM3 *real,imaginary*

This command sets coefficient 3.

INPUDATM4 *real,imaginary*

This command sets coefficient 4.

DATAM3TER

Calculates measurement data by using equation G.1.

Cancel of 1-Point Correction

To cancel a 1-point correction, execute DATAMNONE.

Sample Program

The following program shows a sample of using the DATAMTHRU command.

```
10  ASSIGN @Hp87510 TO 717
20  OUTPUT @Hp87510;"CALIRESP" ! Execute frequency response calibration
30  ON INTR 7 GOTO Sweep_end
40  OUTPUT @Hp87510;"CLES"
50  OUTPUT @Hp87510;"*SRE 4;ESNB 1"
60  REPEAT
70  UNTIL SPOLL(@Hp87510)=0
80  ENABLE INTR 7;2
90  OUTPUT @Hp87510;"STANC"
100 Loop_top:GOTO Loop_top
110 Sweep_end:!
120  OUTPUT @Hp87510;"RESPDONE"
130  DIM Dat(200,1)
140  OUTPUT @Hp87510;"OUTPCALCO1?" ! Reads calibration data array
150  ENTER @Hp87510;Dat(*)
160  OUTPUT @Hp87510;"INPUDATM1";Dat(1,0),Dat(1,1) ! Arbitrary point data
165  ! on trace is as coefficient of DATAMTHRU
170  OUTPUT @Hp87510;"DATAMTHRU"
180  OUTPUT @Hp87510;"SORROW" ! Turn off the frequency response cal.
190  OUTPUT @Hp87510;"CONT"
200  END
```

Difference between 1-Point Correction and Calibration

HP 87510A corrects data automatically by using interpolated error correction feature if the stimulus settings is changed when calibration is turned on. In this case, the HP 87510A calculates error correction data, and this requires some time. On the other hand, 1-port correction applies the same error coefficient for all points. So, a 1-port correction does not need an interpolation time. If error coefficient does not requires consideration of frequency response, you should use a 1-point correction feature to reduce the interpolation time.



Using HP Instrument BASIC with the HP 87510A



Printed in JAPAN December 1991

Notice

The information contained in this document is subject to change without notice.

This document contains proprietary information which is protected by copyright. All rights are reserved. No part of this document may be photocopied, reproduced, or translated to another language without the prior written consent of the Hewlett-Packard Company.

Customer shall have the personal, non-transferable rights to use, copy or modify SAMPLE PROGRAM in this manual for Customer's internal operations. Customer shall use the SAMPLE PROGRAM solely and exclusively for its own purpose and shall not license, lease, market or distribute the SAMPLE PROGRAM or modification or any part thereof.

HP shall not be liable for the quality, performance or behavior of the SAMPLE PROGRAM. HP especially disclaims that the operation of the SAMPLE PROGRAM shall be uninterrupted or error free. This SAMPLE PROGRAM is provided AS IS.

HP DISCLAIMS THE IMPLIED WARRANTIES OF MERCHANTABILITY AND FITNESS FOR A PARTICULAR PURPOSE.

HP shall not be liable for any infringement of any patent, trademark, copyright or other proprietary rights by the SAMPLE PROGRAM or its use. HP does not warrant that the SAMPLE PROGRAM is free from infringements or such rights of third parties. However, HP will not knowingly infringe or deliver a software that infringes the patent, trademark, copyright or other proprietary right of a third party.

MS-DOS[®] is a U.S. registered trademark of Microsoft Corporation.

© Copyright 1991, Yokogawa-Hewlett-Packard, LTD.

Manual Printing History

The manual printing date and part number indicate its current edition. The printing date changes when a new edition is printed. (Minor corrections and updates which are incorporated at reprint do not cause the date to change.) The manual part number changes when extensive technical changes are incorporated.

December 1991..... 1st. Edition

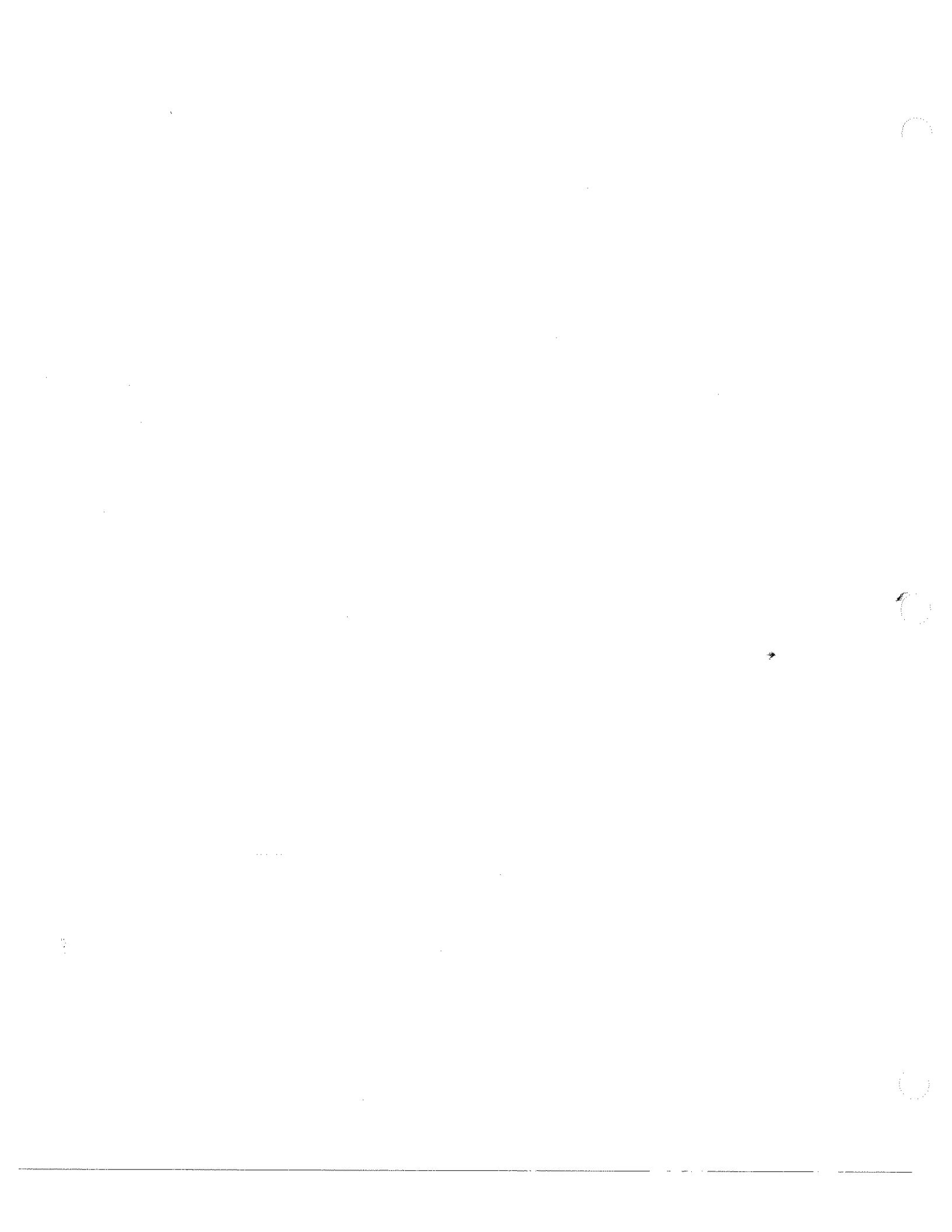

Contents

1. Welcome to HP Instrument BASIC	
Overview of HP Instrument BASIC	1-1
Using HP Instrument BASIC	1-1
How to Use This Manual	1-1
For Experienced Programmers	1-2
2. Preparing to Use HP Instrument BASIC	
Connecting the Keyboard	2-1
About Option of the HP 87510A	2-2
3. Introduction to the System	
Notation Used in this Manual	3-1
Using HP Instrument BASIC with the HP 87510A for the First Time	3-2
Allocating Screen Area for BASIC	3-2
Using the Keyboard	3-3
What can the Keyboard be Used for?	3-3
Performing Calculations from the Keyboard	3-3
Entering Arguments to the Active Instrument Functions	3-3
Entering Titles	3-4
Executing Commands	3-4
Using Softkeys from Keyboard	3-5
Entering BASIC Statements from the Front Panel Keys	3-6
4. Writing and Running Programs	
Getting into/out of the EDIT Mode	4-1
Getting into the EDIT Mode	4-1
Getting out of the EDIT Mode	4-1
Writing Programs	4-2
Controlling the HP 87510A	4-2
Writing an Example Program	4-2
Executing (Running) Programs	4-5
Listing Programs	4-5
Listing on the Screen	4-5
Listing to the Printer	4-5
If You Want to Know More Information	4-6
5. Saving and Getting Programs	
Saving Programs (SAVE)	5-1
Listing File Names (CAT)	5-2
Listing to Screen	5-2
Listing to Printer	5-2
Retrieving Programs (GET)	5-3
If You Need More Information	5-3

6. Editing Programs	
Getting Into/Out of the EDIT Mode	6-1
Getting Into the EDIT Mode using the Front Panel Keys	6-1
Entering the EDIT Mode from the Keyboard	6-1
Getting Out of the EDIT Mode	6-1
Edit Mode Commands	6-2
Deleting Characters	6-2
Back Space	6-2
Delete Character	6-2
Insert Character	6-2
Moving the Cursor	6-2
Scrolling Lines and Pages	6-2
Scrolling Lines	6-2
Scrolling Pages	6-2
Jumping from the Current Line	6-3
Jumping to a Specified Line	6-3
Jumping to the Top/Bottom of a Program	6-3
Insert/Delete/Recall Lines	6-3
Clear Line	6-3
Renumbering Program Line Numbers	6-3
7. Program I/O	
Display Features	7-1
All Instrument	7-2
Half Instrument/Half BASIC	7-2
All BASIC	7-2
BASIC Status	7-2
Run Light Indications	7-3
HP-IB Remote Indicator	7-3
Graphics	7-3
Instrument BASIC Graphics Commands	7-4
Hard Copies	7-4
PLOT	7-4
PRINT	7-4
Initial settings	7-4
Example of Graphics Programming	7-4
Drawing a Straight Line	7-4
Drawing a Circle	7-4
Using the 24-bit I/O port in BASIC programs	7-5
READIO(select_code,register_number)	7-6
WRITEIO select_code,register_number,register_data	7-6
Using the 8-bit I/O Port in BASIC Programs (option 005 only)	7-7
Using the External RUN/CONT Connector	7-7
File System Exceptions	7-7
8. Special Features and Advanced Techniques	
Autoloading and Running a Program Automatically (AUTOST)	8-1
On Key Label Function	8-1
Increasing Program Speed	8-2

9. The HP-HIL Keyboard	
Character Entry Keys	9-1
Cursor-Control and Display-Control Keys	9-2
Numeric Keypad	9-3
Editing Keys	9-3
Program Control Keys	9-4
System Control Keys	9-5
Softkeys and Softkey Control	9-6
Softkey Control Keys	9-6
Softkeys	9-6
Softkeys Accessed from Menu Key	9-7
Edit Menu	9-7
File Utility Menu	9-7
Softkeys Accessed from User System Key	9-8
Using CTRL Key in Edit Mode	9-8
Controlling the Front Panel Keys from the HP-HIL keyboard	9-9
10. Application Programs	
Controlling the HP 87510A Using the Instrument BASIC	10-1
Sending HP-IB Commands to the Gain Phase Analyzer Part of the HP 87510A	10-2
To Send HP-IB the Command in the Ordinary Way	10-2
To Send an HP-IB Command Using the EXECUTE Command	10-2
Detecting the End of Sweep	10-2
Detecting the End of a Single Sweep	10-2
Detecting the End of a Group Sweep	10-3
Executing the Limit Line Test	10-3
Trace Data Transfer	10-5
Output Trace Data	10-5
Input Trace Data	10-5
ON KEY. . . . LABEL Function	10-7
I/O Operation from Instrument BASIC	10-8
Data Transfer Using the 24-bit I/O Port	10-8
Reading Data from the 24-bit I/O Port	10-8
Disk I/O for Built-in Disk Drive	10-9
Saving Trace Data	10-9
Loading Trace Data	10-9
Simultaneously using Instrument BASIC and an External Controller	10-10
Passing Control	10-10
Transferring a Program to Instrument BASIC	10-11
Running an External Instrument BASIC Program	10-11
Accessing the Contents of a Data Array in an Instrument BASIC Program from an External Controller	10-12
Application Programs	10-13
Sharing One Printer Between Two Controllers	10-13
Automatic Program Execution	10-15
BIN Sorting Using the 24-bit I/O Port	10-16

11. HP 87510A Specific HP Instrument BASIC Features	
Available I/O Interface and Select Codes	11-7
Display	11-1
Keyboard	11-2
Disk Drive	11-2
RAM Disk Memory	11-3
BASIC Statements not Implemented	11-4
BASIC Statements Specific to HP 87510A	11-4
HP-IB Commands Specific to HP 87510A's Instrument BASIC	11-4
A. BASIC Commands Specific to HP 87510A	
DATE	A-1
Example Statements	A-1
Semantics	A-2
DATE\$	A-2
Example Statements	A-2
Semantics	A-2
EXECUTE	A-3
Semantics	A-4
GCLEAR	A-4
READIO	A-5
Example Statements	A-5
Semantics	A-6
SET TIME	A-6
Example Statements	A-7
Semantics	A-7
SET TIMEDATE	A-7
Example Statements	A-7
Semantics	A-7
TIME	A-8
Example Statements	A-8
Semantics	A-8
TIME\$	A-9
Example Statements	A-9
Semantics	A-9
WRITEIO	A-9
Example Statements	A-10
Semantics	A-10
B. HP-IB Instrument BASIC Commands	
Notation Conventions and Definitions	B-1
Command Structure	B-1
Basic Rules	B-2
Command Abbreviations	B-3
PROgram Subsystem	B-4
:PROgram:CATalog?	B-4
:PROgram[:SElected]:DEFine <program>	B-4
PROGRAM[:SElected]:DELeTe[:SElected]	B-5
:PROgram[:SElected]:DELeTe:ALL	B-5
:PROgram[:SElected]:EXECute <program command>	B-5
:PROgram[:SElected]:MALLocate {<nbytes> DEFault}	B-5
:PROgram[:SElected]:NAME <programe>	B-5
:PROgram[:SElected]:NUMber <varname>, <nvalues>	B-5
:PROgram[:SElected]:STATe {RUN PAUSE STOP CONTInue}	B-6
:PROgram[:SElected]:STRing <varname>, <svalues>	B-6

:PROGrama[:SElected]:WAIT	B-6
:PROGrama:EXPLicit:DEFine <programe>, <program>	B-6
:PROGrama:EXPLicit:DElete <program>	B-7
:PROGrama:EXPLicit:EXECute <programe>,<program command>	B-7
:PROGrama:EXPLicit:MALLocate <programe>, {<nbytes> DEFault}	B-7
:PROGrama:EXPLicit:NUMBer <programe>,<varname>,<nvalues>	B-7
:PROGrama:EXPLicit:STATe <programe>,{RUN PAUSE STOP CONTInue}	B-7
:PROGrama:EXPLicit:STRing <programe>,<varname>,<svalues>	B-7
:PROGrama:EXPLicit:WAIT	B-7

Index

Figures

2-1. Connecting the HP-HIL Keyboard	2-1
3-1. Command Entry Menu	3-6
7-1. Display Allocation Menu	7-1
7-2. Display Allocation	7-2
7-3. Screen Structure	7-3
7-4. 24-bit I/O Port	7-5
7-5. RUN/CONT Trigger Signal	7-7
9-1. HIL-Keyboard	9-1
9-2. Softkey Menus Accessed from Menu and User System Key	9-7
10-1. Sending HP-IB Command(1)	10-2
10-2. Sending HP-IB Command(2)	10-2
10-3. Detecting the End of A Single Sweep	10-3
10-4. Detecting the End of Group Sweep	10-3
10-5. Executing the Limit Line Test	10-4
10-6. Output ASCII Format Data	10-5
10-7. Output Binary Format Data	10-5
10-8. Input ASCII Format Data	10-6
10-9. Input Binary Format Data	10-6
10-10. On Key Label	10-7
10-11. Reading 24-bit I/O Port	10-8
10-12. Writing Data to the 24-Bit I/O Port	10-8
10-13. Saving Trace data	10-9
10-14. Loading Trace Data	10-9
10-15. Passing Control (for External Controller)	10-10
10-16. Passing Control (for Instrument BASIC)	10-10
10-17. Program Download	10-11
10-18. Run External Instrument BASIC Program	10-11
10-19. Accessing External Controller's Program Array	10-12
10-20. Sharing a Printer (Program for External Controller)	10-13
10-21. Sharing a Printer (Program for Instrument BASIC)	10-14
10-22. Automatic Program Execution (1/2)	10-15
10-23. Automatic Program Execution (2/2)	10-16
10-24. BIN sorting with 24-bit I/O Port	10-17
11-1.	11-3
B-1. Command Tree Example	B-2

Tables

7-1.	7-6
7-2.	7-6
A-1. HP-IB Commands for EXECUTE	A-3

Welcome to HP Instrument BASIC

Welcome to HP Instrument BASIC.

This guide will help you to learn how to effectively use HP Instrument BASIC. It will help you to perform typical operations involving program creation, editing, and execution. It will also show you how to save and recall programs, and how to make the best use of HP Instrument BASIC's front-panel and keyboard interface.

If you are new to programming or to HP's dialect of BASIC, take the time to read this guide and perform the exercises. For many users, this will provide all the information that is needed to create and run programs. If you are familiar with any HP 9000 Series 200/300 BASIC, be sure to read the section "For Experienced Programmers" in this chapter.

Overview of HP Instrument BASIC

When installed in your instrument, HP Instrument BASIC can be used for a wide range of applications from simple recording and playback of measurement sequences to remote control of other instruments.

HP Instrument BASIC is a complete system controller residing inside your instrument. It communicates with your instrument via HP-IB commands and can also communicate with other instruments, computers, and peripherals over the HP-IB interface.

Using HP Instrument BASIC

HP Instrument BASIC can run applications written to enhance your instrument's performance.

HP Instrument BASIC's programming interface includes an editor and a set of programming utilities. The utilities allow you to perform disk I/O, renumber, secure, or delete all or part of your program.

The HP Instrument BASIC command set is similar to the command set of HP 9000 Series 200/300 BASIC. In fact, HP Instrument BASIC programs can be run on any HP BASIC workstation with few if any changes. Porting information can be found in the *HP Instrument BASIC Programming Techniques*.

How to Use This Manual

The tasks in each chapter, when performed in sequential order, demonstrate a typical use of HP Instrument BASIC and covers the most common tasks. Read the overview and try the sample tasks in each chapter to get you started. For more background information, you can read further into each chapter; otherwise, go to the next exercises and continue the session. You can refer back to the individual chapters for more information as necessary. Here is a brief guide to help you locate the necessary information in this manual and the other HP Instrument BASIC manuals.

Note

In this manual, we assume that operator uses HP-HIL keyboard. HP-HIL keyboard is supplied as option. For details about option of the HP 87510A Instrument BASIC, refer to "About Option of the HP 87510A" in Chapter 2.

- Chapter 2 describes how to connect a keyboard. This chapter also provides information for option of the HP Instrument BASIC.
- Chapter 3 introduces the HP 87510A's Instrument BASIC system.
- Chapters 4 and 5 show creating, getting, and saving programs to teach you front panel and keyboard operation.
- Chapter 6 introduces you to the editing environment.
- Chapter 7 describes interfacing features for display, I/O port, external connector to trigger RUN/CONTINUE of a program, and the built-in disk drive.
- Chapter 8 introduces special features for auto loading a program, and the On Key Label function (softkeys defined in a program). This chapter also describes techniques for speeding up your programs.
- Chapter 9 provides a handy reference guide to HP 87510A Instrument BASIC's key definitions for the HP-HIL keyboard.
- Chapter 10 provides application programs and useful techniques for developing programs.
- Chapter 11 summarizes the unique features specified for the HP 87510A.
- The Appendix provides references for BASIC commands and HP-IB commands specific to HP 87510A's Instrument BASIC.
- IF you want to port HP 9000 Series 200/300 BASIC programs to HP Instrument BASIC refer to Chapter 10, "Keyword Guide to Porting", in the *HP Instrument BASIC Programming Techniques*.

For Experienced Programmers

If you are familiar with HP 9000 Series 200/300 BASIC, this manual is a good starting point to introduce you to the Instrument BASIC operating and programming environment, and to provide you with examples of intermediate and advanced HP Instrument BASIC programs.

You will find detailed information on HP Instrument BASIC in the following books:

- *HP Instrument BASIC Programming Techniques*
- *HP Instrument BASIC Interfacing Techniques*
- *HP Instrument BASIC Language Reference*

including keyword descriptions, error messages, interface specifics, and programming techniques.

Preparing to Use HP Instrument BASIC

This chapter will give you the information you need to use HP Instrument BASIC.

Connecting the Keyboard

Note Turn off your instrument before inserting or removing the keyboard connector.



When you use HP Instrument BASIC, connect the furnished keyboard to the HP-HIL connector on the front panel as shown in Figure 2-1

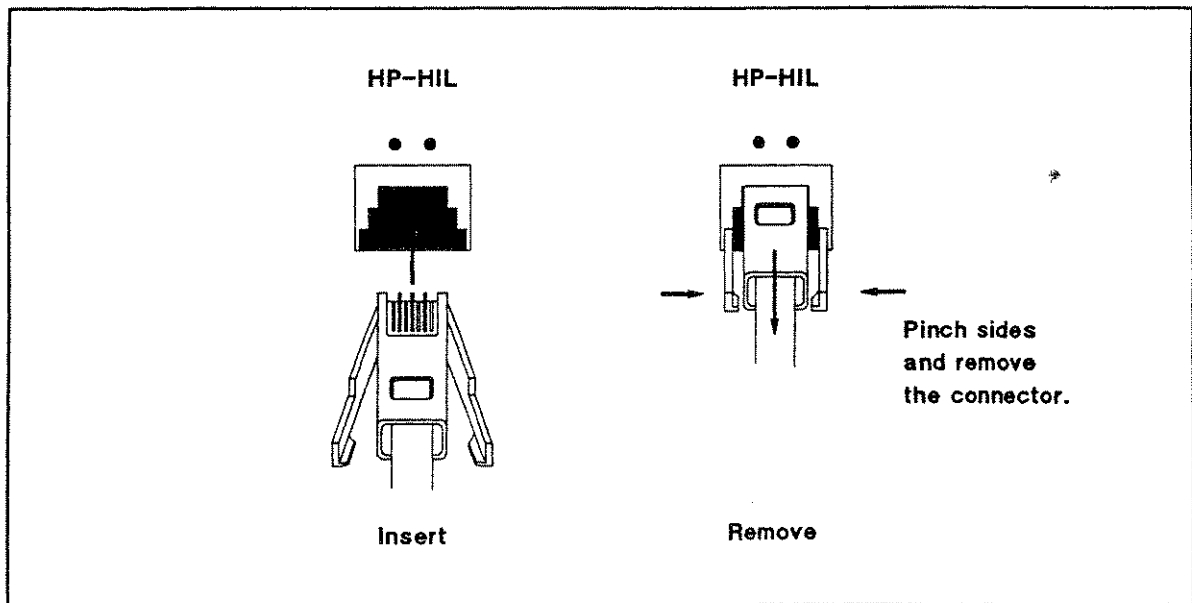

Figure 2-1. Connecting the HP-HIL Keyboard

About Option of the HP 87510A

Following option is prepared for the HP Instrument BASIC of the HP 87510A.

Ordering Information

Product Number	Description
HP 87510A Option 002	HP-HIL Keyboard HP Instrument BASIC Manual Set (This manual set describes the HP Instrument BASIC programming language. This manual set assumes that you have read <i>Using HP Instrument BASIC with the HP 87510A</i> . See the following.)

For more information, contact your nearest Hewlett-Packard office.

Introduction to the System

This chapter describes using the display and the keyboard. Read this chapter before using Instrument BASIC with the HP 87510A for the first time. The topics covered in this chapter are:

- Notation used in this Manual
- Turning on the Analyzer
- Allocating screen area for BASIC
- Using the keyboard
- Entering BASIC Statements from the Front Panel Keys

Notation Used in this Manual

The following list describes the notation used in this manual.

- | | |
|-------------------------|---|
| COMPUTER FONT | This is either what you see as the system's response to your commands, or this is what you should type in exactly as shown in an example. |
| <i>italic font</i> | When you see examples with italics in them, you have to replace the italic words with your own (that is, if the italic word is <i>file_name</i> , then you supply the real file name in place of <i>file_name</i>). |
| Key | If you see a word in a box, it refers to an actual key on your keyboard or to an actual key on the front panel of the HP 87510A; for example, look on your keyboard for Break (upper left on the HP-HIL keyboard). |
| Shift key | When a key is prefaced with Shift , it means you press the Shift key, and hold it down while pressing the next key (like you do when shifting case). |
| Key | If you see a word on a half-tone background, it refers to a softkey on the front panel of the HP 87510A. |

Using HP Instrument BASIC with the HP 87510A for the First Time

Note

If you have not used the HP 87510A, read the *User's Guide* in the *Operation Manual* and study its contents before reading this manual.



Allocating Screen Area for BASIC

Let's try

1. Press the following key and softkeys:

DISPLAY **DISPLAY ALLOCATION** **ALL BASIC**

The screen is cleared and all of the screen area is allocated for BASIC.

2. Press the following softkey:

ALL INSTRUMENT

The total screen area is reallocated as the instrument display.

3. Press the following softkey:

HALF INSTR HALF BASIC

The screen area is allocated so that the upper half of the screen is used for instrument operation and the lower half is used for BASIC.

4. Press the following softkey:

BASIC STATUS

Three blank lines appear at the display line (lower area of the screen). This area is used by BASIC system to input commands and to display messages.

Since all of the HP 87510A's screen is allocated for instrument operation after power ON, allocate screen area for BASIC when you want to use it. The HP 87510A provides four display allocation types. Select one of them using the softkey **DISPLAY ALLOCATION** under **DISPLAY**.

More information on the display allocations for the BASIC area is described in "Display Features" in Chapter 7.

Using the Keyboard

What can the Keyboard be Used for?

The HP-HIL keyboard can be used as follows:

- Performing Calculations from the keyboard
- Entering active functions
- Entering titles
- Executing commands
- Controlling the Instrument

The following sample operations show you how to use these functions.

Performing Calculations from the Keyboard

1. Press the following key and softkeys:

DISPLAY **DISPLAY ALLOCATION** **ALL BASIC**

The screen is cleared and a cursor appears at the bottom left of screen.

2. Type like this:

3*2 **Return**

The characters you type are displayed at the current cursor position. After pressing **Return**, the system responds with the answer at the bottom of screen like this:

6

You can perform calculations while in any display allocation type except for ALL INSTRUMENT.

You can use arithmetic operations such as:

- + for addition
- for subtraction
- / for division
- * for multiplication
- ^ for exponentiation

as well as parenthesis. For a list of evaluation priority of arithmetic expressions, see "Numeric Computation" in the *HP Instrument BASIC Programming Techniques* Part of the *HP Instrument BASIC Users Handbook*.

Entering Arguments to the Active Instrument Functions

The numeric keys on the keyboard can be used to input the arguments for an active instrument function the same as using the front panel keys.

1. Press the following key and softkeys:

DISPLAY **DISPLAY ALLOCATION** **ALL INSTRUMENT**

2. Then press the following key:

START

The current start frequency is displayed on the screen and becomes the active instrument function.

3. Type a value to change the frequency from the keyboard. For example, type this:

100000

The START value is cleared and the value you typed is displayed.

4. Then press the following key form the keyboard:

(Return)

The START value is changed to 100 kHz.

5. Next, type the following value and key:

2E6 **(Return)**

After pressing **(Return)** the active function value is changed to 2 MHz. You can use the character "E" and "e" in an exponential expression.

Pressing **(Back space)** on the keyboard deletes the last entry. This performs the same function as pressing **(BACK SP)** on the front panel.

Entering Titles

The character entry keys can be used to enter a title on the screen instead of using front panel operation.

Example Procedure

1. Press the following key and softkey:

(DISPLAY) TITLE

A cursor appears at the top left of the graticule.

2. Type in characters using the keyboard, the characters you type appear at the top of the graticule.
3. Press the following key to terminate entry:

(Return)

You can enter standard upper-case and lower-case letters for the title, using the **(Shift)** key to access the alternate case as usual. For more information on the character entry keys see "Character Entry Keys" in Chapter 9.

Executing Commands

You can type in and execute commands from the keyboard at all times except when:

- the display allocation is "ALL INSTRUMENT"
- there is currently a command being executed.
- EDIT mode

At all other times, you can type in commands and press **(Return)** to present them to the system for execution. The system parses the command and takes the appropriate action.

Example Command (Checking System Identification)

1. Press the following key and softkey:

(DISPLAY) HALF INSTR HALF BASIC

2. To check system identification, type the following command:

```
SYSTEM$("SYSTEM ID") Return
```

3. The system returns:

```
HP 87510A
```

Using Softkeys from Keyboard

Pressing **f1** through **f8** on the keyboard performs the same function as pressing a softkey on the front panel.

Entering BASIC Statements from the Front Panel Keys

HP 87510A Instrument BASIC allows you to enter and execute statements from the front panel keys, if the external HP-HIL keyboard is not connected.

Press the following key and softkeys from the front panel:

SYSTEM **IBASIC** **FILE UTILITY** **COMMAND ENTRY**

The Command Entry menu is displayed on the softkey menu area (as shown in Figure 3-1), and the active entry area displays the letters, the digits 0 through 9, and some special characters including mathematical symbols. Three sets of letters can be scrolled using the step keys, **↑** and **↓**. To enter a statement, press the step keys for the desired letter set, rotate the knob until the arrow "↑" points at the first letter, then press **SELECT LETTER**. Repeat this until the complete statement is entered, then press **DONE** to execute the statement.

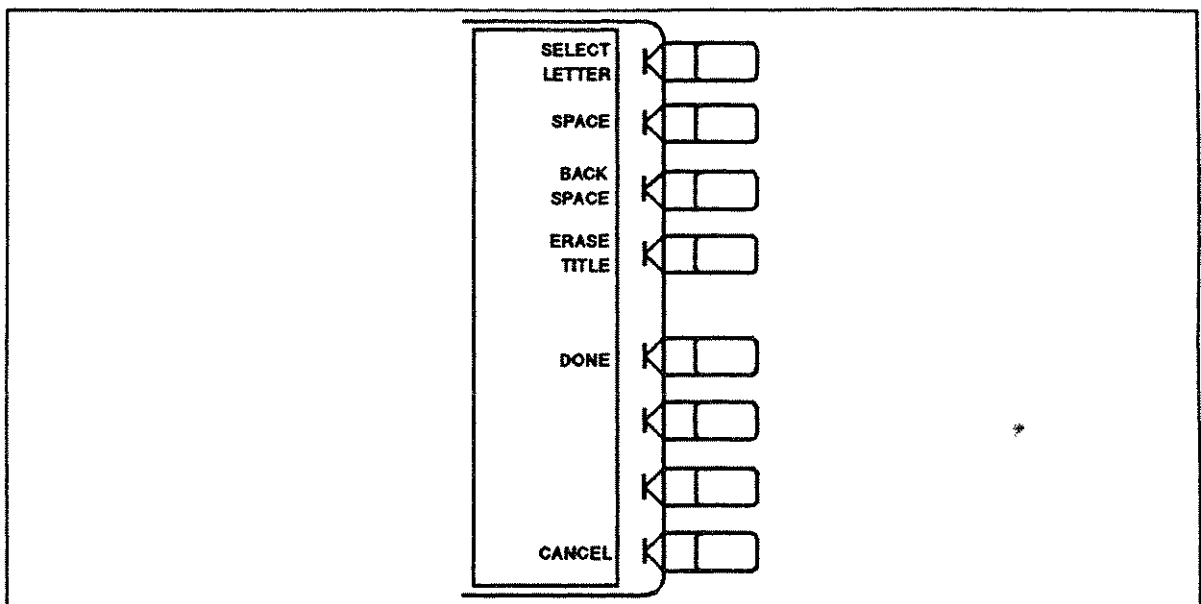

C2703001

Figure 3-1. Command Entry Menu

SELECT LETTER selects the character pointed to by "↑".

SPACE inserts a space.

BACK SPACE deletes the last character entered.

ERASE TITLE deletes all characters entered.

DONE terminates command entry, and executes the command you entered.

CANCEL cancels command entry and returns to the BASIC menu.

Writing and Running Programs

This chapter describes how to write, execute (run), and list programs. The example program in this chapter also describes how to control the HP 87510A from an HP Instrument BASIC program. Topics covered in this chapter are:

- Getting into/out of the EDIT mode
- Writing programs
- Running programs
- Listing programs

Getting into/out of the EDIT Mode

When you write a program, you must be in the EDIT mode.

Getting into the EDIT Mode

Press the following key and softkeys from the front panel:

SYSTEM **IBASIC** **Edit**

The system enters the EDIT mode. You can also get into the EDIT mode when the Display Allocation is not ALL INSTRUMENT. Type EDIT and press **Return** from the keyboard (for more information about the EDIT mode, see Chapter 6).

Getting out of the EDIT Mode

Press the following softkey from the front panel:

END EDIT

The system exits the EDIT mode. If **END EDIT** does not appear on the softkey menu, press

SYSTEM **IBASIC** from the front panel, **END EDIT** will appear at the bottom of the menu.

You can also get out of the EDIT mode from the keyboard. Press **Stop**, **ESC**, or **Clear display**, and the system will immediately exit the EDIT mode.

Writing Programs

Controlling the HP 87510A

Instrument BASIC system can control the instrument (itself) through the "internal" HP-IB bus. This means that the HP 87510A with Instrument BASIC includes both a controller and an instrument in the same box which are connected through an internal HP-IB bus.

Note



The following example program assumes that the HP 87510A's HP-IB address is 17 (factory setting). Press the following keys to set your analyzer's address to 17, if it was set to another address.

LOCAL **SET ADDRESSES** **ADDRESS : 87510** 17 **X1**

Since the select code of the *internal* HP-IB interface is 8, the device selector of the analyzer in the example programs is 817.

For more information on HP-IB addresses and device selectors, refer to "Device Selectors" in the *HP Instrument BASIC Interfacing Techniques* furnished with Option 002 and "Available I/O Interface and Select Codes" in Chapter 11.

Writing an Example Program

The following example program selects the following measurement settings:

Channel Block	Channel 1 (default)
Response Block	A/R LOG MAG format (default) Display scale to 0.5 dB/DIV
Stimulus	Center frequency: 70 MHz Span frequency: 100 kHz

The examples in this guide can be performed by pressing keys and softkeys from the front panel procedure without using the external keyboard.

Let's Try

1. Turn the instrument ON.
2. Press the following key and softkeys from the front panel:

SYSTEM **IBASIC** **Edit**

The system enters the EDIT mode. The cursor appears at line number 10, which is the default line number of the first program line, as follows:

10 _

3. Press the following softkey:

ASSIGN @Hp87510

The commands are automatically entered at the current cursor position like this:

```
10 ASSIGN @Hp87510 TO 800_
```

4. Press the following key:

(X1)

The system reads the entire line.

```
10 ASSIGN @Hp87510 TO 800
20 _
```

5. Press the following softkey:

OUTPUT @Hp87510

The following characters are displayed on the screen:

```
10 ASSIGN @Hp87510 TO 800
20 OUTPUT @Hp87510;""
```

6. Press the following key and softkey to preset the instrument:

PRESET

The HP-IB command to preset the instrument "PRES" is automatically entered at the current cursor position like this:

```
10 ASSIGN @Hp87510 TO 800
20 OUTPUT @Hp87510;";PRES"
```

Then press **(X1)**.

7. Press the following key to select measurement parameter as A/R:

OUTPUT @Hp87510 **MEAS** **A/R**

The program code is automatically generated:

```
10 ASSIGN @Hp87510 TO 800
20 OUTPUT @Hp87510;";PRES"
30 OUTPUT @Hp87510;";AR"
```

Then enter **(X1)**.

8. Press the following keys and softkeys to set the center frequency and frequency span:

SYSTEM IBASIC OUTPUT @Hp87510 CENT 70 M/μ SPAN 100 k/m X1

```
10 ASSIGN @Hp87510 TO 800
20 OUTPUT @Hp87510;" ;PRES"
30 OUTPUT @Hp87510;" ;AR"
40 OUTPUT @Hp87510;" ;CENT 70E6;SPAN 100E3"
50 _
```

9. Then press the following keys and softkeys to execute the auto scale function:

OUTPUT @Hp87510 SCALE REF AUTO SCALE X1

```
10 ASSIGN @Hp87510 TO 800
20 OUTPUT @Hp87510;" ;PRES"
30 OUTPUT @Hp87510;" ;AR"
40 OUTPUT @Hp87510;" ;CENT 70E6;SPAN 100E3"
50 OUTPUT @Hp87510;" ;AUTO"
60 _
```

10. To terminate the program, the END command should be entered. Press the following softkey and key:

END X1

```
10 ASSIGN @Hp87510 TO 800
20 OUTPUT @Hp87510;" ;PRES"
30 OUTPUT @Hp87510;" ;AR"
40 OUTPUT @Hp87510;" ;CENT 70E6;SPAN 100E3"
50 OUTPUT @Hp87510;" ;AUTO"
60 END
70 _
```

11. Press the following softkey to exit the EDIT mode:

END EDIT

The screen returns back to the instrument display.

You can write the same program from the keyboard. Using the keyboard is very useful when you write a larger and more complex program, type comments in a program, etc. On how to use the keyboard, refer to Chapter 9.

Executing (Running) Programs

Press the following key and softkeys from the front panel to execute the program:

SYSTEM **IBASIC** **Run**

The system executes the program. You can execute the RUN statement from keyboard. When you execute a statement from the keyboard, the BASIC command line must be allocated on the screen. If it is not, you must allocate it. For example:

DISPLAY **DISPLAY ALLOCATION** **BASIC STATUS**

And then type RUN command and press **Return** key from the key board as follows:

RUN **Return**

Listing Programs

The system can list the program on the screen and to a printer.

Listing on the Screen

You can list a program on the screen as follows:

1. Since the system lists a program in the print area, the Print Area must be allocated on the screen. For example:

DISPLAY **DISPLAY ALLOCATE** **ALL BASIC**

All of the screen area is allocated for the print area.

2. Type as follows:

LIST **Return**

The system lists the program as follows:

```
10 ASSIGN @Hp87510 TO 800
20 OUTPUT @Hp87510;"PRES"
30 OUTPUT @Hp87510;"AR"
40 OUTPUT @Hp87510;"CENT 70E6;SPAN 100E3"
50 OUTPUT @Hp87510;"AUTO"
60 END
```

Listing to the Printer

Note For hard copy output, an HP-IB cable must connect the analyzer to the printer.



1. Tell the HP 87510A the printer's address.

- a. Set the printer's address to 1. If you don't know how to set its address, refer to the printer's manual.
- b. Check that the address recognized as the printer by the HP 87510A is 1 (factory set value) as follows:

LOCAL SET ADDRESSES ADDRESS : PRINTER

The address is displayed on the screen. If the address displayed is not 1, press the following keys:

1 **(X1)**

2. Set the output device to a printer as follows:

PRINTER IS 701 Return

3. Type and press as follows:

LIST Return

The program is listed on the printer.

4. To again list to the scree, type:

PRINTER IS CRT

If You Want to Know More Information

This chapter is an introduction to using HP Instrument BASIC. For more information, see the following chapters and documents.

For more information on ..	see..
EDIT mode	Chapter 6
Keyboard and softkeys	Chapter 9
Display Allocation	"Display Features" in Chapter 7
HP Instrument BASIC commands	<i>HP Instrument BASIC Language Reference</i> furnished with Option 002
HP-IB commands	<i>HP-IB Programming Manual</i> and Appendix B

Saving and Getting Programs

This chapter describes how to save and get programs to or from the built-in disk and RAM disk memory. Topics of this chapter are:

- Saving programs
- Listing file names
- Getting programs

Note  HP Instrument BASIC on the HP 87510A can communicate only with the built-in disk drive and RAM disk memory, not an external disk drive.

If you are using the disk drive for the first time, see "Disk Drive Tutorial" in Chapter 5 of the *HP 87510A User's Guide*.

Note  The HP 87510A can use either LIF(Logical Interchange Format) or DOS formatted disks. The instrument automatically detects the disk format. It is able to use most of the same operations for either disk format.

Saving Programs (SAVE)

1. If the display allocation is All Instrument, change the allocation. For example:

DISPLAY **DISP ALLOCATION ALL BASIC**

2. Press the **Menu** key from the keyboard and press the keys and softkeys shown and type in the filename to which you will store the program

Menu **FILE UTILITY** **SAVE** *file-name* **Return**

The program is stored on the disk.

Note  To lead to the **FILE UTILITY** softkey, press the **Menu** key on the HP-HIL keyboard, do not use the **MENU** key on the front panel. Pressing the **MENU** key on the front panel will lead to the Stimulus menu, not lead **FILE UTILITY**.

Note  If you get "ERROR 54 Duplicate file name", a file on the disk already has the name you are trying to use. In this case, you have three choices:

- Pick a new file name that doesn't already exist. To determine which file names are already being used, execute the "CAT" command (see below).
 - You may want to replace the existing file with a new one. To replace an existing file, use the "RE-SAVE" statement.
 - PURGE the old file, then SAVE the new one.
-

Listing File Names (CAT)

Listing to Screen

Press the following keys and softkeys:

1. If the display allocation is All Instrument or BASIC STATUS, change the allocation to either Half INSTRUMENT Half BASIC or ALL BASIC. For example:

DISPLAY **DISP ALLOCATION ALL BASIC**

2. Then press the following keys and softkeys (press **Menu** key on the keyboard):

Menu **FILE UTILITY CAT** **Return**

The file names stored on the disk are listed on the screen.

Note



Since the CAT statement outputs 80 columns to a line and the maximum number of columns to a screen is 58, each line is wrapped at the 59th column. If you do not want the list to wrap around, execute the following statement before executing the CAT command.

PRINTER IS CRT;WIDTH 80

CAT will list the file names with no wrap around, but anything after the 59th column in the output can not be seen.

Listing to Printer

Note



For hard copy output, an HP-IB cable must connect the analyzer to the printer.

1. Tell the HP 87510A the printer's address.

- a. Set the printer's address to 1. If you don't know how to set its address, refer to the printer's manual.
- b. Check the address recognized as printer by the HP 87510A is 1 (factory set value) as follows:

LOCAL **SET ADDRESSES ADDRESS : PRINTER**

The address is displayed on the screen. If the address displayed is not 1, press the following keys:

1 **X1**

2. Set the output device to be a printer as follows:

PRINTER IS 701;WIDTH 80 **Return**

3. Type and press as follows:

CAT **Return**

The program is listed on the printer.

4. Get the output device back to CRT:

PRINTER IS CRT **Return**

Retrieving Programs (GET)

You can retrieve a program from the disk as follows:

1. If the display allocation is All Instrument, change the allocation to either Half INSTRUMENT Half BASIC or ALL BASIC. For example:

DISPLAY **DISP ALLOCATION ALL BASIC**

2. Press the following keys and softkeys and type the filename you want to retrieve:

Menu (on the keyboard) **FILE UTILITY** **GET** *file-name* **Return**

If You Need More Information

This chapter is an introduction to saving and retrieving programs on a disk. For more information, see the following chapters and documents:

For more information on ..	see.
File Utilities for BASIC	"File Utility Menu" in Chapter 9
Initializing a disk	"Initialize Menu" in Chapter 11 of <i>HP 87510A Reference Manual</i>
Downloading a program	"Transferring a Program to Instrument BASIC" in Chapter 10

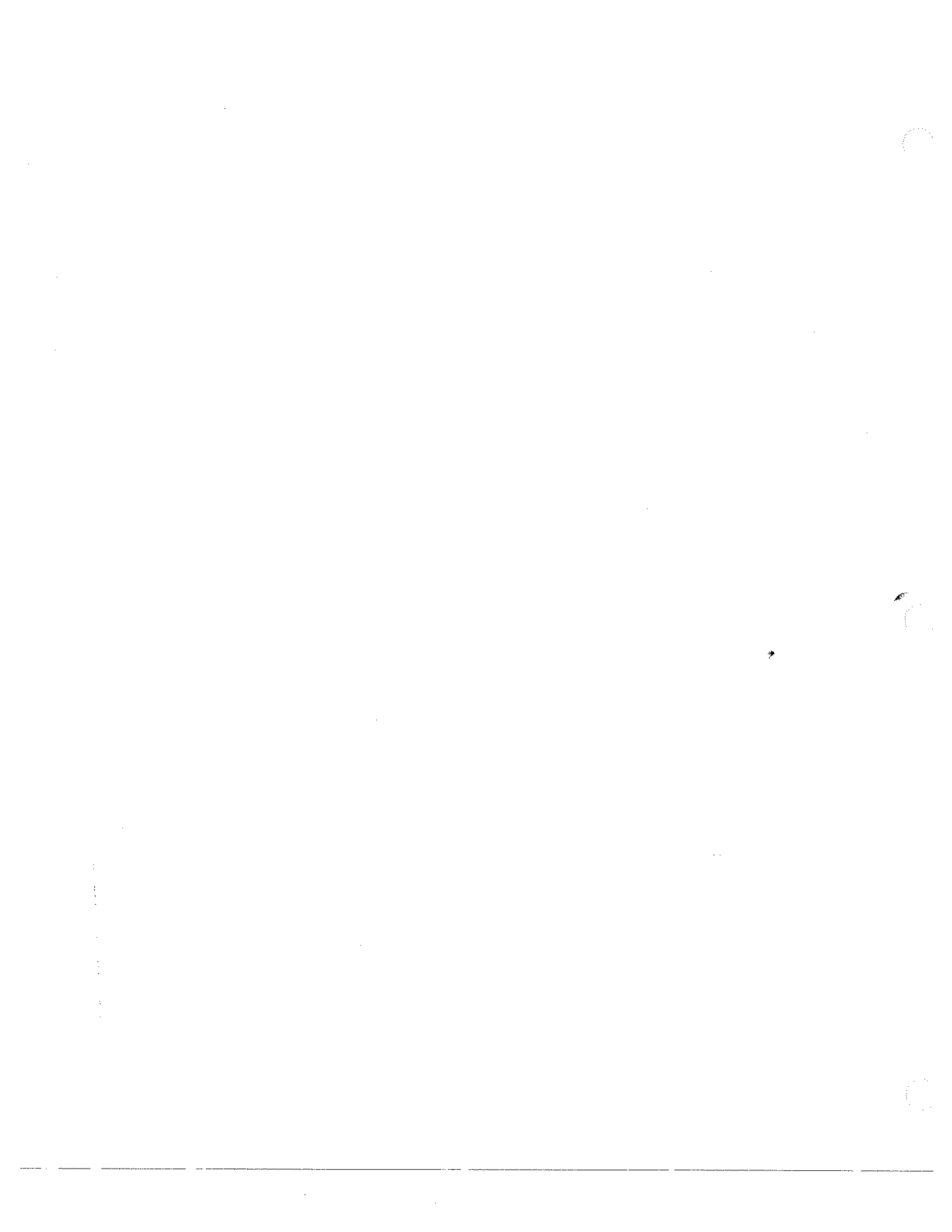

Editing Programs

This section describes how to edit programs using the EDIT mode. The topics covered in this section are:

- Getting into/out of the EDIT mode
- Editing programs in the EDIT mode
- Renumbering programs

Getting Into/Out of the EDIT Mode

Getting Into the EDIT Mode using the Front Panel Keys

Pressing the following keys and softkey allows you to enter the EDIT mode immediately, irrespective of Display Allocation.

SYSTEM **IBASIC** **Edit**

Entering the EDIT Mode from the Keyboard

Press/type the following keys to enter the commands and parameter to enter the EDIT mode with the cursor positioned at the specified line number. The *line number* can be omitted.

Menu **EDIT** *line_number* **Return**

(Press the **Menu** key on the keyboard)

or

EDIT *line_number* **Return**

To use the keyboard, the Keyboard Input Line must be allocated on the screen. If it is not, press **DISPLAY** **DISPLAY ALLOCATION** and select any allocation except for All Instrument.

Getting Out of the EDIT Mode

The EDIT mode is exited by pressing **Stop**, **ESC**, and **Clear display** from keyboard, or pressing the **END EDIT** softkey.

Edit Mode Commands

This section describes how to edit a program while in the EDIT mode, the topics are:

- Deleting characters
- Inserting characters
- Moving the cursor
- Scrolling lines and pages
- Jumping lines
- Inserting/deleting/recalling lines
- Clearing lines

Deleting Characters

There are two functions you can use to delete characters, "Back space" and "Delete character".

Back Space

Pressing **BACK SP** on the front panel or **Back space** on the keyboard erases the character to the left of the cursor and moves cursor left to the position of the erased character.

Delete Character

Pressing **Delete char** from the keyboard deletes the character at the cursor's position.

Insert Character

The EDIT mode is always in the insert mode. Characters you type at the keyboard are inserted before the current cursor position. (Pressing **Insert char** performs no function.)

Moving the Cursor

The following key operations allow you to move the cursor horizontally along a line.

From the front panel	From the keyboard
Turning the knob	Pressing ← and →

Scrolling Lines and Pages

Scrolling Lines

The following key operations enable you to scroll lines up and down.

From the front panel	From the keyboard
Pressing ↑ and ↓	pressing ▲ and ▼

Scrolling Pages

Pressing **Prev** and **Next** from the keyboard causes the display to scroll up and down in one-half page increments.

Jumping from the Current Line

Jumping to a Specified Line

You can specify a line by using a line number or a label name when jumping from the current line as follows:

GOTO LINE *line_number* (Return)

or

GOTO LINE *label_name* (Return)

If the label specified is not defined in the program, an error will occur.

Jumping to the Top/Bottom of a Program

Pressing the following keys allows you to jump to top or bottom of the program.

(Shift) (▲)

(Shift) (▼)

Insert/Delete/Recall Lines

(Insert line) inserts a new line above the current cursor position.

(Delete line) deletes the line at which the cursor is at.

RECALL LINE recalls the last deleted line.

Clear Line

Pressing (Clear line) clears a line from the current cursor position to the end of the line.

Renumbering Program Line Numbers

The REN command allows you to renumber the program currently in memory. You should execute the REN command after exiting the EDIT mode. Press the following keys and softkey, to renumber a program (press the (Menu) key on the keyboard).

(Menu) **RENumber** (Return)

You can specify the starting value, increment value, beginning line number, and the ending line number when renumbering a program as follows (press (Menu) key on the keyboard):

(Menu) **RENumber** *starting_value, increment IN beginning_line_number, ending_line_number*

line_label can be also use instead of *line_number*. For more information refer to the *HP Instrument BASIC Language Reference* furnished with Option 002.



Program I/O

This chapter describes how to write programs that use the CRT, the 24-bit I/O port(8 bit I/O port if option 005 was installed), the external RUN/CONT connector in the HP 87510A, and the DOS file system.

Topics covered in this chapter are:

- Display features
- Modifying text color
- Graphics
- I/O port
- External RUN/CONTinue connector
- Using the file system

Display Features

There are four allocation types. **DISPLAY ALLOCATION** under the **DISPLAY** key allows you to select one of the four allocation types.

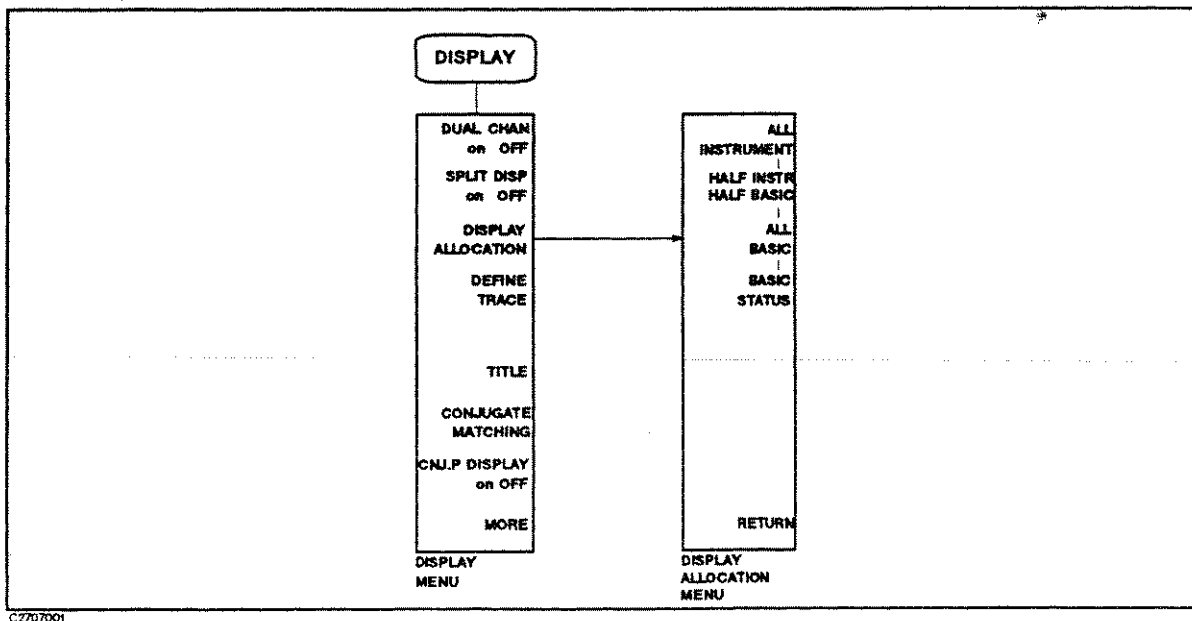

Figure 7-1. Display Allocation Menu

All Instrument

This is the default allocation. In this allocation, all of the screen area is allocated for the instrument display (graticule, parameter display, measurement readings). You can not enter BASIC statements from the keyboard when the All Instrument allocation is in effect.

Half Instrument/Half BASIC

The upper half of the screen is allocated as the instrument screen and the lower half is allocated as the BASIC screen.

All BASIC

All of the screen is allocated for BASIC.

BASIC Status

In this mode, the graticule shrinks and three lines at the bottom of screen are allocated for BASIC.

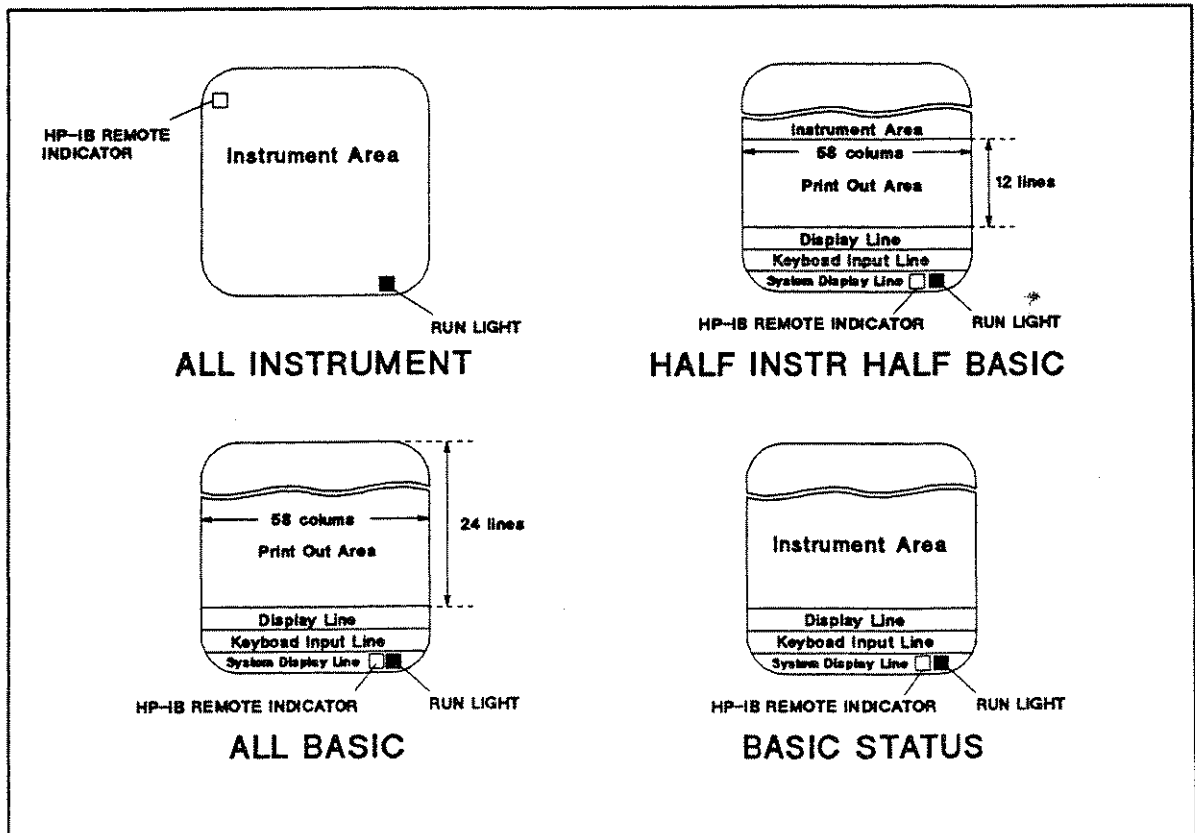

C2707002

Figure 7-2. Display Allocation

Run Light Indications

□ (blank)	Program stopped; can execute commands; CONTINUE not allowed.
-	Program paused; can execute commands; CONTINUE is allowed.
?	BASIC program waiting for input from keyboard; cannot execute commands.
*	This indication has two possible meanings: <ol style="list-style-type: none">1. Program running; can NOT execute commands. CONTINUE not allowed.2. System executing command entered from keyboard; can NOT enter commands.

HP-IB Remote Indicator

"RMT" is displayed when the analyzer is in the remote state. In the All Instrument mode screen allocation, this indicator is displayed at the upper left of screen. In the other screen allocations, it is displayed at lower right of screen.

Graphics

HP 87510A Instrument BASIC adds graphics capability to the HP 87510A. You can draw pictures on the CRT display independent of the grids and traces.

The HP 87510A has two screens, the instrument screen and the graphics screen. These two screens are always displayed together on the CRT and are not separately selectable. The instrument screen consists of a trace display area and a softkey label area. The Instrument BASIC editor is also displayed on the trace display area. The graphics screen covers the entire instrument screen as shown in Figure 7-3. The graphics screen is like an independent transparent overlay in front of the instrument screen. So, you can draw figures in both the trace display and softkey label areas.

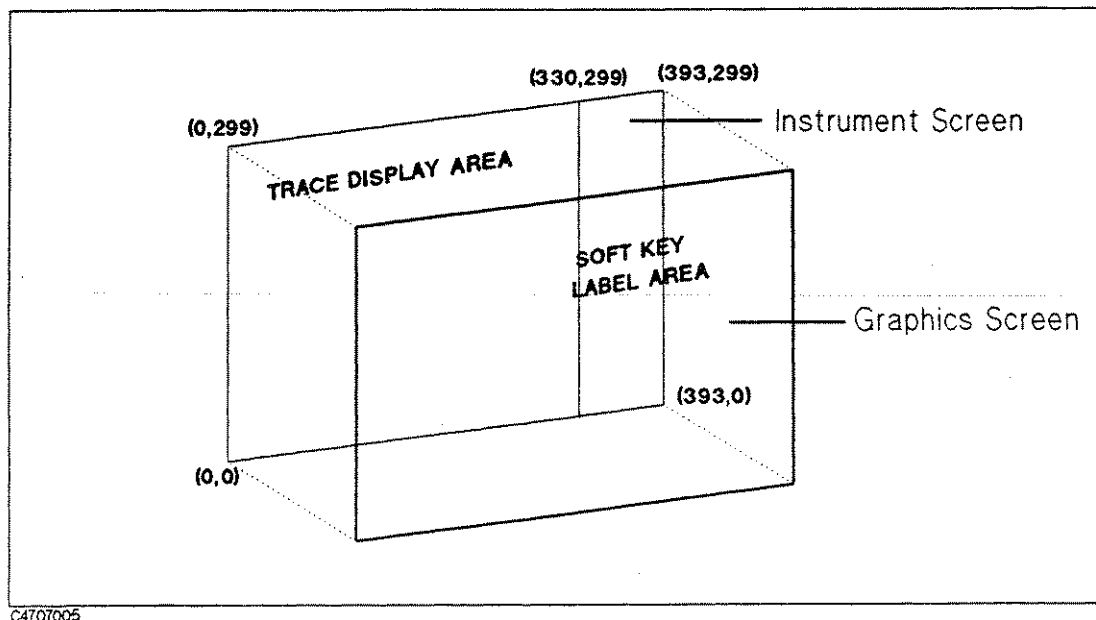

Figure 7-3. Screen Structure

Each point on the graphics screen is addressable using a coordinate address as shown in Figure 7-3. The bottom left corner is the origin (0,0) and the top right corner is the maximum horizontal and vertical end points (393,299). The MOVE and DRAW statement parameters are specified using these coordinate values. Since the aspect ratio of a graphics screen is 1, you need not adjust aspect ratio when drawing figures.

Instrument BASIC Graphics Commands

HP 87510A Instrument BASIC has three graphics commands; MOVE, DRAW, and GCLEAR.

MOVE moves the pen from its current position to the specified coordinates.
DRAW draws a line from the current pen position to the specified coordinates.
GCLEAR clears the graphics screen, moves the pen from its current position to the origin (0,0), and selects pen 1.

Hard Copies

Graphics hard copies can be obtained with the printing or plotting function.

PLOT

PLOT under **(COPY)** plots the display image (both of an instrument screen and a graphics screen) to a graphics plotter. Plotter pens are specified by the PEN number.

PRINT

PRINT under **(COPY)** prints a display image on a printer. Refer to Chapter 10 of *Reference of HP 87510A Operation Manual*.

Initial settings

When power is turned ON, the default settings are as follows:

- MOVE 0,0

Example of Graphics Programming

This section describes an example of a simple program for drawing lines on the graphics screen.

Drawing a Straight Line

The following Instrument BASIC program will draw a line from coordinate (50,200) to coordinate (300,200) on the display.

```
GCLEAR          ! INITIALIZE GRAPHICS MODE
MOVE 50,200     ! MOVE PEN TO COORDINATE (50,200)
DRAW 300,200    ! DRAW A LINE TO COORDINATE (300,200)
END
```

Drawing a Circle

Trying to express all graphical images using only straight lines is tedious, slow, and difficult. This example describes a subprogram you can use to draw a circle. It can draw a circle by passing the center coordinates and the radius as arguments to the following subroutine. This subroutine can be used as a base for drawing arcs, setting different values for Theta, etc.

```
SUB Drawcircle(Centx,Centy,R)  !
```

```

DEG                                ! USE DEGREES FOR ANGLE EXPRESSIONS
X=Centx+R                          !
Y=Centy                            !
MOVE X,Y                          ! MOVE PEN TO INITIAL POINT
For Theta=1 to 360                !
  X=INT(COS(Theta)*R+Centx)        ! NEXT X COORDINATE ON CIRCLE
  Y=INT(SIN(Theta)*R+Centy)        ! NEXT Y COORDINATE ON CIRCLE
  DRAW X,Y                        ! DRAW LINE TO NEXT POINT ON CIRCLE
NEXT Theta                        ! UNTIL STARTING POINT IS REACHED
SUBEND                             !

```

Using the 24-bit I/O port in BASIC programs

The HP 87510A has 24-bit I/O(Input/Output) port for data input and output. This I/O port can assign as 8 kinds of port from A port to H port. Figure 7-4 shows pin assignment of the 24-bit I/O port.

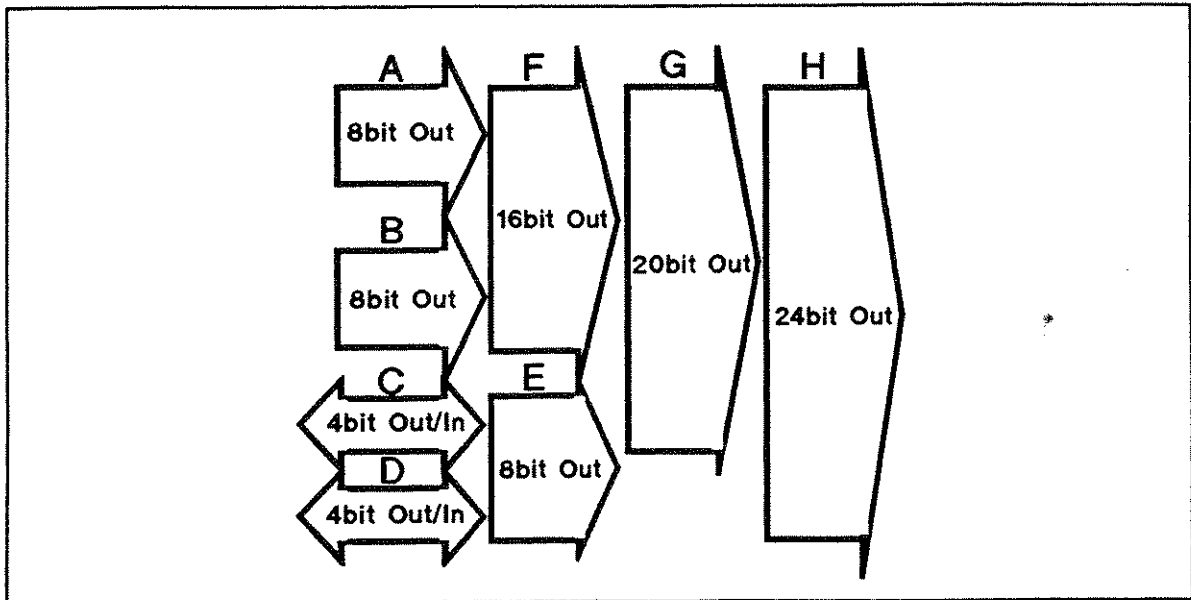

Figure 7-4. 24-bit I/O Port

Instrument BASIC can directly control the 24-bit I/O port without using HP-IB commands. This is faster than using HP-IB commands.

To control I/O port, following commands are used:

READIO(select_code,register_number)

This command reads data from specified I/O port. I/O port is specified by register number as listed in "READIO" in Appendix A. HP 87510A has 3 types of input port.

Table 7-1.

Port Name	Register Number	Number of Bits
Port C	2	4
Port D	3	4
Port E	4	8

Select cort is always 15 in HP 87510A.

WRITEIO select_code,register_number,register_data

This command writes data to specified I/O port. I/O port is specified by registser number as listed in Table 7-2. HP 87510A has 8 types of output port.

Table 7-2.

Port Name	Register Number	Number of Bits
Port A	0	8
Port B	1	8
Port C	2	4
Port D	3	4
Port E	4	8
Port F	5	16
Port G	6	20
Port H	7	24

Select cort is always 15 in HP 87510A.

For more information on the 24-bit I/O port, refer to "I/O port" in Appendix C of *HP 87510A Reference Manual*. Sample procedures to use the 8 bit I/O port are shown in "I/O Operation from Instrument BASIC" in Chapter 10 in this manual.

For details about form of READIO and WRITEIO commands, refer to Appendix A.

Using the 8-bit I/O Port in BASIC Programs (option 005 only)

Instrument BASIC can directly control the 8-bit I/O port without using HP-IB commands. This is faster than using HP-IB commands.

`READIO(15,0)` reads 4-bit data from the 8-bit I/O Port and returns as decimal value.
`WRITEIO 15,0;` outputs decimal value of 8-bit data to the OUT 0 thru 7 lines of the 8-bit I/O port. The OUT 0 signal is the LSB (least significant bit), while the OUT 7 signal is the MSB (most significant bit).

Note An error may occur with any select code other than 15, and with any register number other than 0.



For more information on the 8-bit I/O port, refer to "I/O port" in Appendix C of *HP 87510A Reference Manual*.

Using the External RUN/CONT Connector

You can use the RUN or CONT commands in a program by inputting a TTL-compatible signal to the External RUN/CONT connector on the rear panel. At the positive-going edge of a pulse more than 20 μ sec wide (T_p) in the LOW state will trigger RUN or CONT.

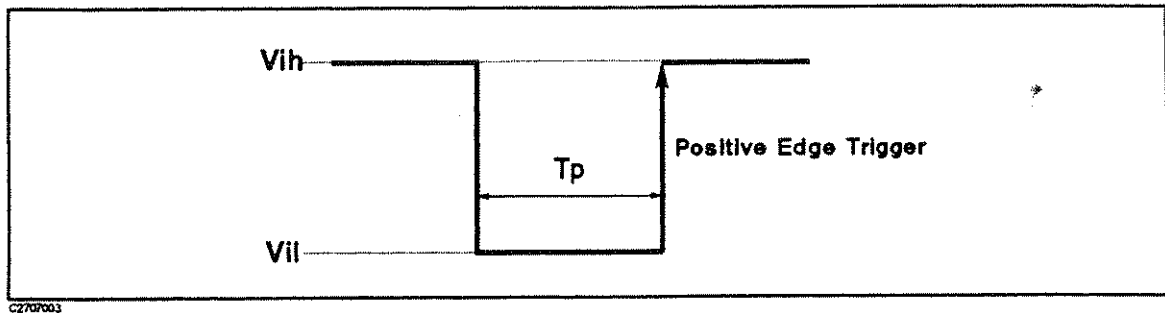

Figure 7-5. RUN/CONT Trigger Signal

File System Exceptions

The HP 87510A supports both a LIF and DOS file formats. When using the LIF format disk, the CREATE and CREATE DIR commands will generate an error. Since the HP 87510A does not support an external disk drive, the MASS STORAGE IS (MSI) statement cannot specify volumes other than the built-in disk drive (volume specifier "INTERNAL,4", the default volume) and RAM disk memory.



Special Features and Advanced Techniques

The topics covered in this chapter are :

- Auto start feature
- On key label function
- Increasing program speed

Autoloading and Running a Program Automatically (AUTOST)

The HP 87510A allows you to create a special program file called "AUTOST". This program is automatically loaded and run every time the HP 87510A is turned ON.

When you use this capability, the disk on which you saved AUTOST must be inserted in the disk drive before the HP 87510A is turned ON.

The first checks to see if there an "AUTOREC" file on the disk, if there is the system reads the AUTOREC file to set up the instrument and then loads and runs the AUTOST program. (For more information on AUTOREC, refer to Chapter 11 of *HP 87510A Reference Manual*.)

On Key Label Function

HP Instrument BASIC allows you to define softkeys from within a program. The softkey labels you define will appear when pressing the **User** key on the Keyboard. The labels are displayed while running the program.

The ON KEY statement is used to define the softkeys. For example:

```

.....
100 ON KEY 1 GOTO 150
110 ON KEY 2 LABEL "Print",2 GOSUB Report
.....

```

The KEY statement is used to display the softkey labels defined. The following set of statements is same as key stroke of **SYSTEM** **IBASIC** **ON KEY LABEL** :

```

.....
200 OUTPUT @Hp8751;"KEY 44"      ! SYSTEM key
210 OUTPUT @Hp8751;"KEY 0"      ! IBASIC softkey
220 OUTPUT @Hp8751;"KEY 7"      ! ON KEY LABEL softkey
.....

```

For more information on the ON KEY statement, refer to the *HP Instrument BASIC Language Reference* furnished with Option 002.

Example programs for ON KEY LABEL keys are shown in Chapter 10.

Increasing Program Speed

Since the HP 87510A's CPU interleaves processing measurements and executing a program, program execution speed depends on the measurement conditions. The display process also requires processing time.

To increase program speed (increase throughput), set the HP 87510A to the following conditions:

- If you do not need to measure DUT during executing a program, set TRIGGER MODE to HOLD.
- If you need to measure DUT but do not need to display traces on the screen, set DISPLAY ALLOCATION to ALL BASIC.
- If you need to measure DUT and display traces but do not need to use marker function, set all markers to OFF.
- If you need to measure DUT, display traces, and marker functions but do not need to display markers on the screen, use the MARK OFF HP-IB command to erase the marker display.
- When you use the 8-bit I/O port, use the READIO and WRITEIO commands.
- If you change channels in a program, set Dual Channel to ON before changing channels.
- Use EXECUTE command for HP-IB command processing. For details about EXECUTE command, refer to "EXECUTE" in Appendix A.

For example, when you change channels in a program, set Dual Channel to ON and Display Allocation to All BASIC to decrease the switching time between channels 1 and 2.

The HP-HIL Keyboard

The HP-HIL keyboard keys are arranged into the following functional groups:

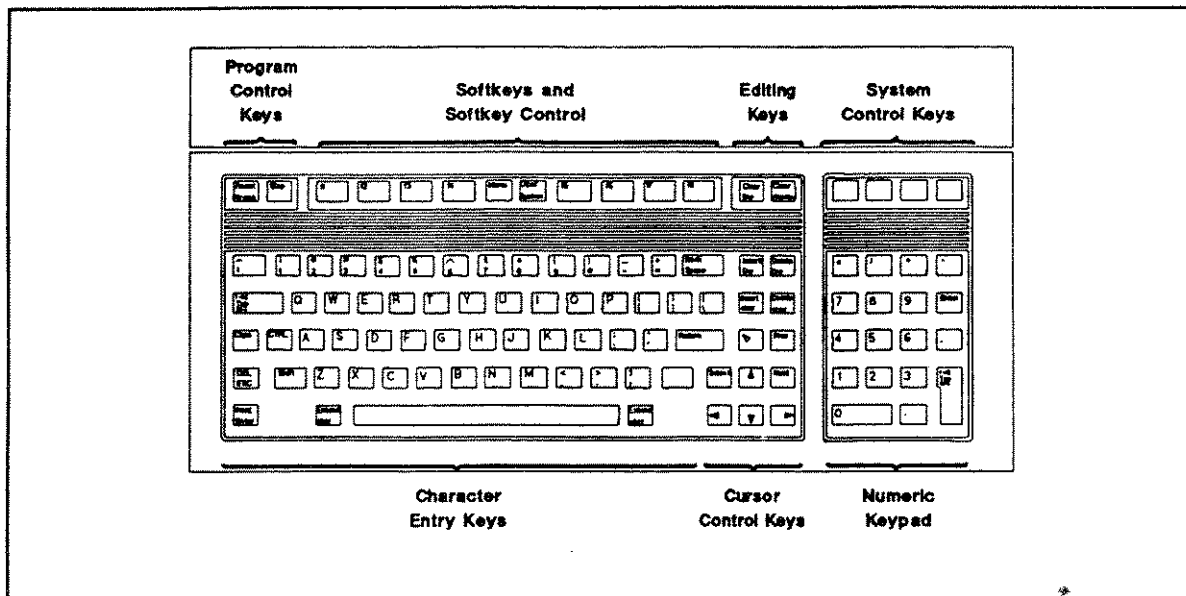

C2709001

Figure 9-1. HIL-Keyboard

Character Entry Keys

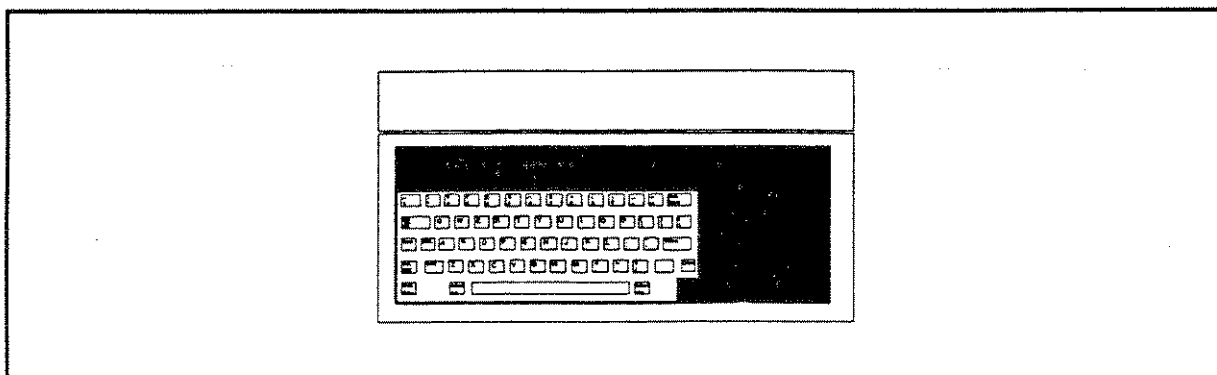

C2709002

The character entry keys are arranged in the familiar QWERTY typewriter layout, but with additional features.

9 THE HP-HIL KEYBOARD

Caps

sets the unshifted keyboard to either upper-case (which is the default after power ON) or lower-case (normal typewriter operation).

Shift

You can enter standard upper-case and lower-case letters, using the **Shift** key to access the alternate case.

Return

has three functions:

- When a running program prompts you for data, respond by typing in the requested data and then press **Return**. This signals the program that you have provided the data and that it can resume execution.
- When typing in program source code, the **Return** key is used to store each line of program code.
- After typing in a command, the **Return** key causes the command to be executed.
- In the EDIT mode, the **Return** key is used to store each line of program code.

Enter

is the same as pressing the **Return** key.

Print

(Shift-Enter) performs no function.

CTRL

In the EDIT mode, **CTRL** allows you to control the editor in the same as using the cursor-control, display-control, and editing keys. For more detail, refer to "Using **CTRL** Key in Edit Mode".

Select

The select key performs no function.

Back space

erases the character to the left of the cursor and moves the cursor to the erased character's position on the line.

Tab

performs no function.

Cursor-Control and Display-Control Keys

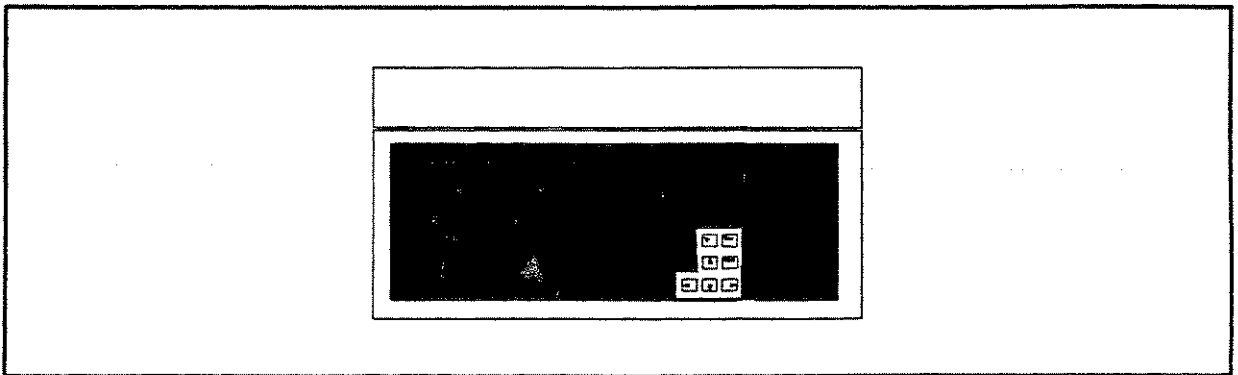

C2709004

▲ ▼

allow you to scroll lines up and down in the print display area. Shifted, these keys cause the display to scroll towards the top or bottom of the display.

▶ ◀

allow you to move horizontally along a line. Shifted, these keys allow you to "jump" to the left and right limits of the current line.

Next **Prev**

cause the display to scroll up or down in one-half page increments.



performs no function.

Numeric Keypad

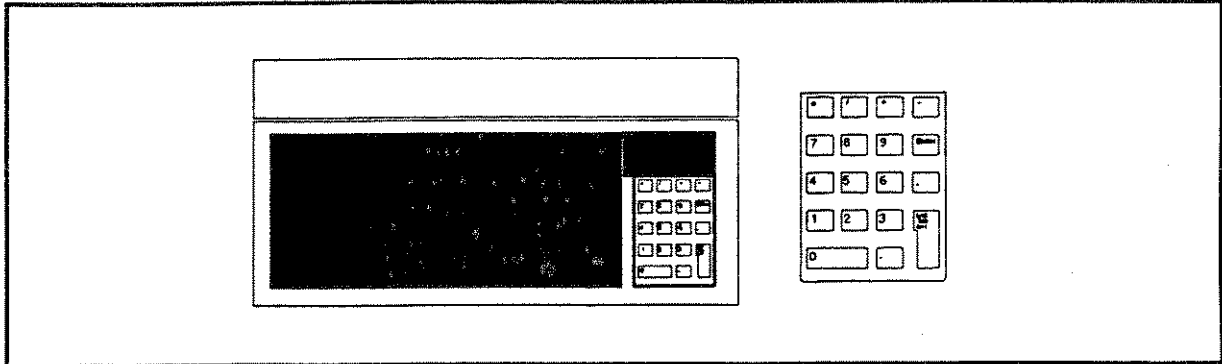

C2709006

The numerical keypad provides a convenient way to enter numbers and perform arithmetic operations. Just type in the arithmetic expression you want to evaluate, then press **Enter**. The result is displayed in the lower-left corner of the screen.

Enter

performs the same function as the **Return** key. The numerical keypad serves the same function as the numerical keypad on the front panel of the HP 87510A.

Tab

performs no function.

Editing Keys

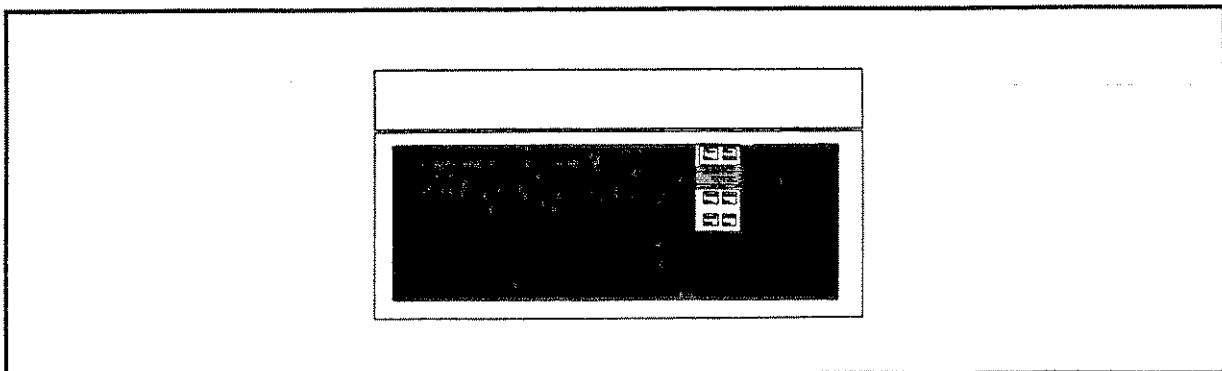

C2709006

Insert line

inserts a new line above the cursor's current position (edit mode only).

Delete line	deletes the line containing the cursor (edit mode only).
Insert char	performs no function. HP Instrument BASIC is always in the insert mode. The characters you type are always inserted to the left of the cursor.
Delete char	deletes the character at the cursor's position.
Clear line	clears from the current cursor position to the end of the line.
Clear display	clears the entire alpha screen. In EDIT mode, this exits the EDIT mode.

Program Control Keys

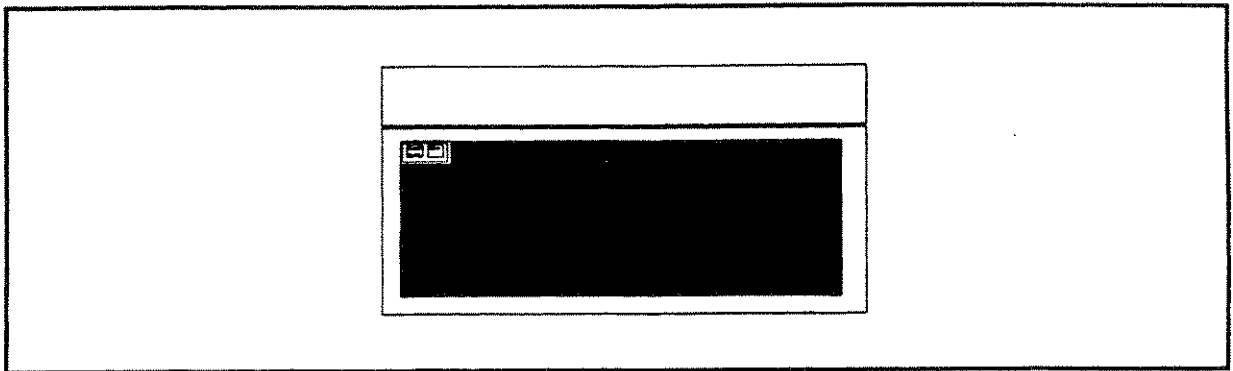

C2709007

The following keys allow you to control execution of the program stored in the analyzer's memory.

- Stop** Unshifted-**Stop** pauses program execution after the current line. Pressing **Continue** in the System menu resumes program execution from the point where it was paused.
- Shift-Stop** stops program execution after the current line. To restart the program, press **Run** in the System menu.
- When in the editor mode, **Stop** exits the edit mode.
- Break** pauses program execution when the computer is performing or trying to perform an I/O operation. Press **Break** instead of unshifted-**Stop** when the computer is hung up during an I/O operation, because unshifted-**Stop** works only after the computer finishes the current program line.
- Shift-Break** resets program execution immediately without erasing the program from memory (**BASIC RESET**).

System Control Keys

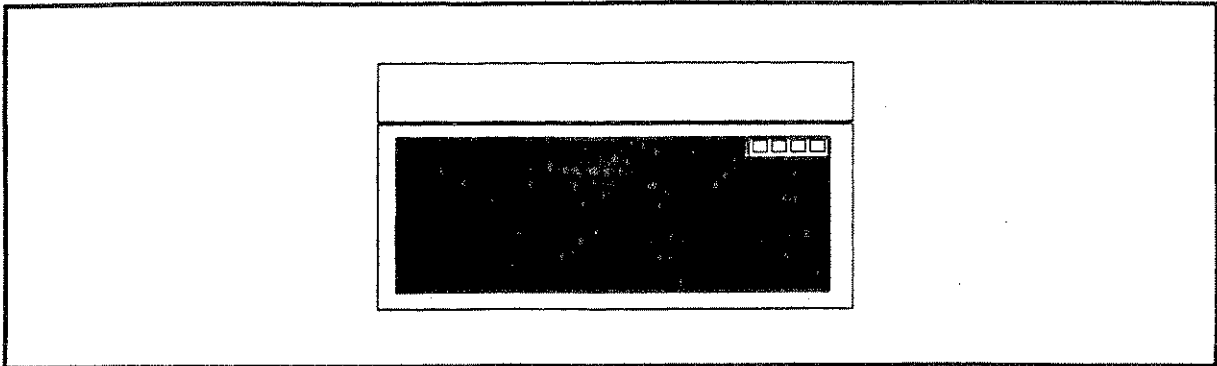

C2709008

The unlabeled keys above the numeric keypad control various system functions related to the program.

To easily identify the keys in the following description, we'll use the following convention:

- **Key-1**—Above the ***** key.
- **Key-2**—Above the **/** key.
- **Key-3**—Above the **+** key.
- **Key-4**—Above the **-** key.

Key-1 (Recall) Unshifted-**Key-1** (Recall) recalls the last line the you entered, executed, or deleted. Several previous lines can be recalled this way. Recall is particularly handy to use when you mistype a line. Instead of retyping the entire line, you can recall it, edit it using the editing keys, and enter or execute it again.

Shift-Key-1 moves forward through the recall stack.

Key-2 (Run) starts a program running from the beginning.

Key-3 (Continue) resumes program execution from the point where it was paused.

Key-4 (IBASIC) allows you to type BASIC commands on Keyboard Input Line. If Display Allocation is All Instrument, pressing this key changes the Display Allocation to BASIC Status.

Shift-Key-4 changes Display Allocation to All Instrument.

Softkeys and Softkey Control

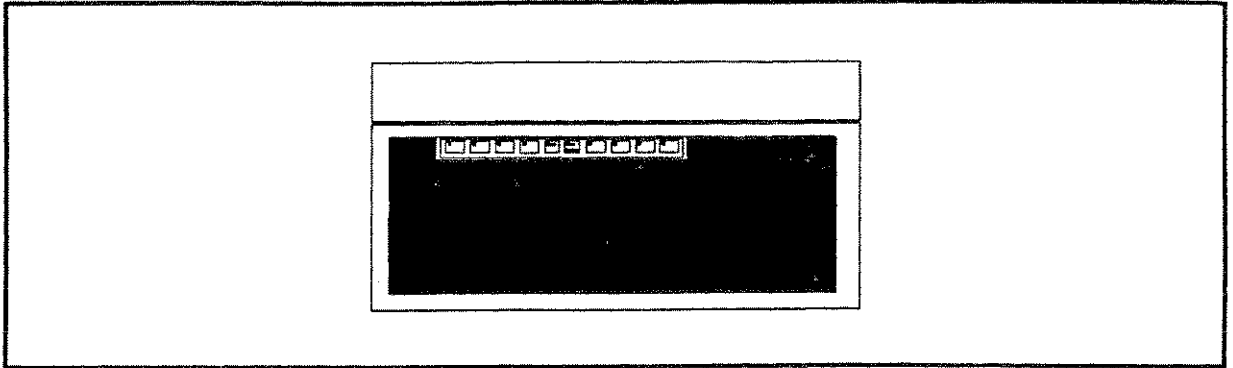

C2709009

There are eight softkeys (labeled **f1** through **f8**) and two keys that control the definition of the softkeys (**Menu**) and (**User System**). The softkey labels are indicated on the right of the HP 87510A's screen.

Softkey Control Keys

Pressing the following:

Menu leads to the Edit menu, which controls programs and the editor.

User System (Unshifted-**User System**) leads to the BASIC menu from which to control a BASIC program. This menu is the same menu displayed when pressing **SYSTEM** **BASIC** from the front panel.

In the edit mode, pressing **User System** leads to the Edit System menu, which provides softkeys to conveniently enter BASIC commands.

Shift-User System (**User**) leads to the ON KEY LABEL menu, which are user defined softkeys in a BASIC program. (For information on getting to this menu through Instrument BASIC, see "On Key Label Function" in Chapter 8.)

Softkeys

Figure 9-2 shows the softkey menus accessed from the **Menu** and **User System** keys. Pressing a softkey performs the command labeled or produces a sequence of characters on the keyboard input line (or on the "current line" in the EDIT mode).

Pressing the softkeys on the front panel of the HP 87510A performs the same functions as pressing the **f1** through **f8** function keys.

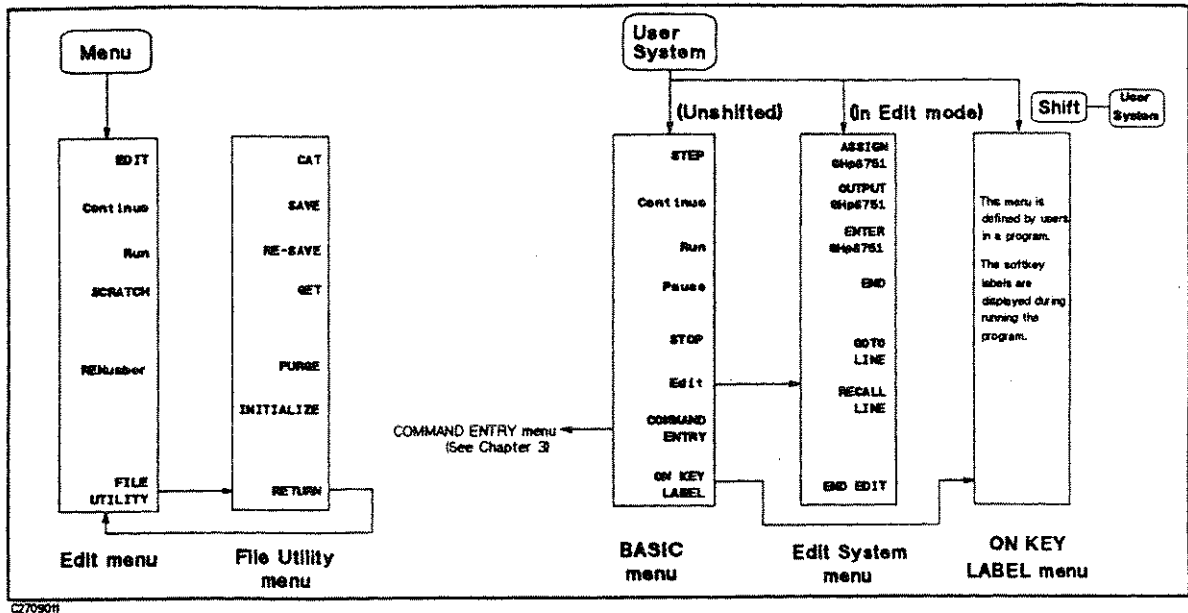

Figure 9-2. Softkey Menus Accessed from **Menu** and **User System** Key

Softkeys Accessed from **Menu** Key

Edit Menu

Pressing the following:

- EDIT** produces the command "EDIT" on the keyboard input line. After EDIT is entered, pressing **Return** enters the edit mode.
- Continue** resumes program execution from the point where it was paused.
- Run** immediately executes a program.
- SCRATCH** produces the command "SCRATCH". The SCRATCH erases the program in memory. After SCRATCH is entered, pressing **Return** executes the command.
- RENumber** produces the characters "REN". REN rennumbers all of the program lines currently in memory.
- FILE UTILITY** leads to the File Utility softkey menu to access the disk.

File Utility Menu

Pressing the following:

- CAT** produces the command "CAT". CAT lists the contents of a mass storage directory.
- SAVE** produces the command "SAVE"". SAVE creates an ASCII file and copies program lines as strings into that file.
- RE-SAVE** produces the command "RE-SAVE"". RE-SAVE creates a specified ASCII file if it does not exist; otherwise, it re-writes a specified ASCII file by copying program lines as strings into that file.
- GET** produces the command "GET"". GET reads the specified ASCII file and attempts to store the strings into memory as program lines.

PURGE

produces the command "PURGE". PURGE deletes a file or directory from the directory of a mass storage media.

INITIALIZE

produces the command "INITIALIZE". INITIALIZE prepares mass storage media for use by the computer. When INITIALIZE is executed, any data on the media is lost.

RETURN

goes back to Edit menu.

Softkeys Accessed form **User System** Key

User System key allows you to access three different softkey flows dependent on conditions as follows:

- Pressing unshifted-**User System** accesses the Program Control menu
- Pressing **Shift**-**User System** accesses the ON KEY LABEL menu.
- In editor mode, pressing unshifted-**User System** accesses the Edit System menu

Above listed menus are described in Chapter 12 of *HP 87510A Operation Manual*.

Using **CTRL** Key in Edit Mode

In the edit mode, pressing **CTRL**, holding it down and pressing another key, allows you to control the editor in the same way as pressing control keys such as **▲**, **▼**, **Insert line**, etc.

If you press ...	It performs ...
CTRL -a	moves the cursor to beginning of line, (the same function as Shift - ←).
CTRL -b	moves cursor backward one character, (the same function as ←).
CTRL -d	deletes a character, (the same function as Delete char).
CTRL -e	moves the cursor to end of the line, (the same function as Shift - →).
CTRL -f	moves cursor forward character along a line, (the same function as →).
CTRL -g	allows you to move the cursor to any line number or label, after press CTRL -g, type a line number or label name and press Return , the cursor moves to the specified line, (the same function as GOTO LINE).
CTRL -h	deletes backward one character, (the same function as Back Space).
CTRL -i	performs the same function as Return .
CTRL -k	deletes a line from the cursor's current position to the end of the line.
CTRL -m	performs the same function as Return .
CTRL -n	moves the cursor to the next line, (the same function as ▼).
CTRL -o	inserts a new line above the cursor's current position, (the same function as Insert line).
CTRL -p	moves the cursor to the previous line, (the same function as ▲).

Controlling the Front Panel Keys from the HP-HIL keyboard

Pressing **Extend char** along with another key allows you to control the front panel keys of the HP 87510A. The following table shows which key performs the same function as the key on the HP 87510A's front panel.

If you press ...	It performs the same function as pressing ...
Extend char 1	MKR key
Extend char 2	MKR FCTN key
Extend char 3	ATTEN key
Extend char 4	DISPLAY key
Extend char 5	AVE key
Extend char 6	CAL key
Extend char 7	MEAS key
Extend char 8	FORMAT key
Extend char 9	SCALE REF key
Extend char Select	SYSTEM key
Extend char ▲	LOCAL key
Extend char Next	PRESET key
Extend char ◀	COPY key
Extend char ▼	SAVE key
Extend char ▶	RECALL key
Extend char Menu	MENU key
Extend char Clear line	CH 1 key
Extend char Clear display	CH 2 key
Extend char Key-1 ¹	STOP key
Extend char Key-2 ²	START key
Extend char Key-3 ³	CENTER key
Extend char Key-4 ⁴	SPAN key

1 Above the **⊞** key

2 Above the **/** key

3 Above the **+** key

4 Above the **-** key

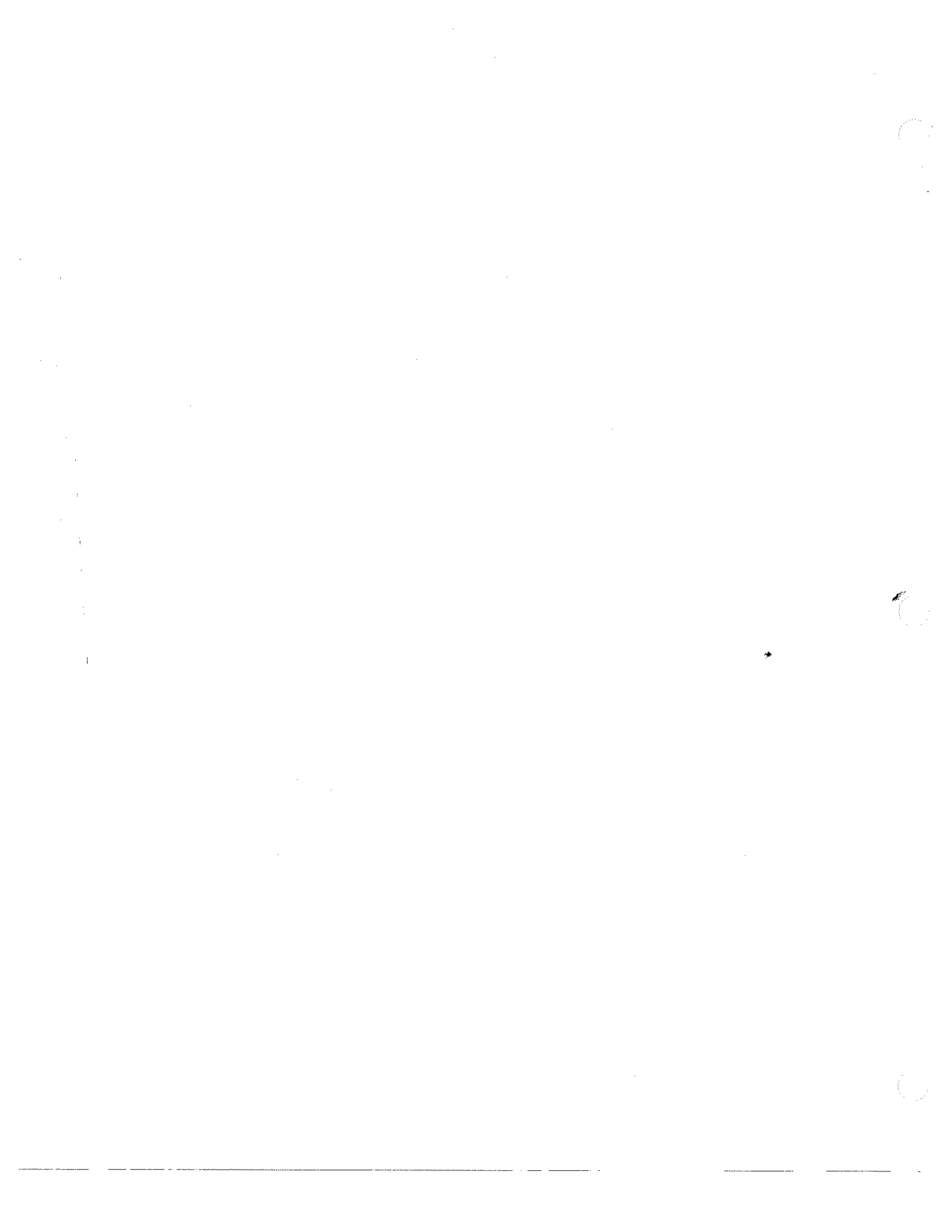

Application Programs

This chapter discusses HP Instrument BASIC programming with examples. Examples correspond to actual measurement situations. These Instrument BASIC examples will supply useful information for developing HP 87510A Instrument BASIC application programs. Included are several typical types of programs and three application programs for the HP 87510A. The topics covered in this chapter are:

- Sample programs for controlling the HP 87510A
- Sample programs for I/O operation
- Sample programs for using Instrument BASIC simultaneously with an external controller
- Application programs

Controlling the HP 87510A Using the Instrument BASIC

HP Instrument BASIC will allow you to easily control the HP 87510A. This section describes the basic techniques for using Instrument BASIC to control the HP 87510A. In this section, the following sample programs are described:

- Sending HP-IB commands to the HP 87510A
- Detecting end of sweep
- Executing the limit line test
- Trace data transfer
- ON KEY.... LABEL function

Note



Two quotes, in succession, will embed a quote within a string when a quotation mark needs to be in a string.

For example:

```
100 OUTPUT @Hp87510;";TITL ""This is a test."" "
```

Sends string, ;TITL "This is a test., to the HP 87510A. (TITL displays a title.)

```
200 File_name$="TEST"
210 OUTPUT @Hp87510;"SAVDDAT""";File_name$;""""
```

Sends string, SAVDDAT "TEST", to the HP 87510A. (SAVDDAT saves internal data arrays.)

Sending HP-IB Commands to the Gain Phase Analyzer Part of the HP 87510A

To Send HP-IB the Command in the Ordinary Way

The gain phase analyzer and HP Instrument BASIC in the HP 87510A should be regarded as two separate instruments interfaced by an internal HP-IB bus. So, to distinguish between the internal and external HP-IB interfaces, use select code "8" for the internal HP-IB interface, (the external select code is "7"). For more information on HP-IB commands, refer to *HP-IB Programming Manual*. This sample program sends the HP-IB command by using the HP-IB interface from Instrument BASIC to the analyzer.

```
10 ASSIGN @Hp87510 TO 800 ! Assign HP-IB path to the HP 87510A
20 OUTPUT @Hp87510;"LOGM;" ! Set HP 87510A to LOG MAG formant
30 END
```

Figure 10-1. Sending HP-IB Command(1)

To Send an HP-IB Command Using the EXECUTE Command

```
10 ASSIGN @Hp87510 TO 800
20 WRITEIO 8,0; 100E6 ! Store start frequency,100 MHz to register 0
30 WRITEIO 8,1; 200E6 ! Store stop frequency, 200 MHz to register 1
40 EXECUTE "ANARANG" ! "ANARANG" command need two parameters
50 !
60 EXECUTE "OUTPRES0?" ! "OUTPRES0?" query returns four parameters
70 Za=READIO(8,0) ! Read first return value, Za from register 0
80 Fa=READIO(8,1) !
90 Zr=READIO(8,2) ! same as line 70
100 Fr=READIO(8,3) !
110 PRINT Za," ",Fa," ",Zr," ",Fr
120 END
```

Figure 10-2. Sending HP-IB Command(2)

Detecting the End of Sweep

When you execute sweep of the HP 87510A from instrument BASIC, you must wait to send next HP-IB command until the sweep is completed. If you send next HP-IB command before the sweep is completed, this command may not be accepted correctly to the HP 87510A. For this reason, you must detect end of sweep in your instrument BASIC program, except for single sweep with EXECUTE command.

Detecting the End of a Single Sweep

SING command which makes sweep one time, with EXECUTE command, waits until the sweep is completed. So, in this case, you must try not to detect the end of sweep in your program. Figure 10-3 shows an example of SING with EXECUTE command.

```

10 ASSIGN @Hp87510 TO 800
20 EXECUTE "SING"
30 PRINT "SWEEP COMPLETED"
40 END

```

Figure 10-3. Detecting the End of A Single Sweep

Detecting the End of a Group Sweep

When you execute a group sweep, the end of sweep is detected from condition of a status register bit. The HP 8751A's *Event Status register B* (ESB) which is one of status registers, reports the instrument status of the HP 8751A. The status bit named "SING, NUMG, Cal. Std Complete Bit" in the ESB returns a bit value of 1 when a single sweep or group of sweeps have been completed. For details of ESB, SRE, and ESNB, refer to *HP-IB Programming Manual*.

This sample program shows how to detect the end of measurement sweep using Instrument BASIC. In Figure 10-3, Instrument BASIC declares "ON INTR" (ON INTERRUPT) in line 50. When the end of sweep is detected as an SRQ (Service ReQuest) and the program branches to a specified subprogram. SRE and ESNB must be enabled before ON INTR is used. This sample program is useful when you want to process something only while a sweep is in progress.

```

10 ASSIGN @Hp87510 TO 800
20 !
30 OUTPUT @Hp87510;"*CLS" ! \
40 OUTPUT @Hp87510;"*SRE 4" ! > Initialize to enable SRQ
50 OUTPUT @Hp87510;"ESNB 1" ! /
60 ON INTR 8 GOTO Jump
70 ENABLE INTR 8
80 OUTPUT @Hp87510;"NUMG 30"
90 GOTO 90 ! Repeat this line until sweep is completed
100 !
110 Jump:! ! When 30 times sweep completed, come to this line
120 PRINT "SWEEP COMPLETED"
130 END

```

Figure 10-4. Detecting the End of Group Sweep

Executing the Limit Line Test

This sample program shows how to transfer an Instrument BASIC limit line table to the HP 87510A and execute limit line test. By using this sample program, you can easily create a complex table. To increase the number of limit segments, add to the "DATA" line (lines 140 through 170) and adjust the "FOR" statement (line 190) accordingly.

```

10 !PROGRAM LIMIT LINE
20 !
30 ASSIGN @Hp87510 TO 800
40 OUTPUT @Hp87510;"DISAALLI" ! Set display mode to All Instrument
50 OUTPUT @Hp87510;"HOLD"
60 !                               Limit Line Table
70 !---- Frequency(MHz) -- Upper Limit(dB) -- Lower Limit(dB)
80 DATA      30,                -40,                -80
90 DATA      65,                 0,                 -15
100 DATA     70,                 0,                 -20
110 DATA     100,                -30,                -70
120 !
130 FOR I=1 TO 4                    ! If you change number of DATA,
140   READ Stimulus(I),Upper(I),Lower(I) ! increase value of I.
150 NEXT I                            !
160 !
170 OUTPUT @Hp87510;"LIMILINEON" !
180 OUTPUT @Hp87510;"EDITLIMIL" ! Start editing the limit line table
190 OUTPUT @Hp87510;"LIMCLEL" !
200 !
220 FOR I=1 TO                      ! Modify this line
230   OUTPUT @Hp87510;"LIMSADD"
240   OUTPUT @Hp87510;"LIMS ";Stimulus(I);"MHz"
250   OUTPUT @Hp87510;"LIMU ";Upper(I)
260   OUTPUT @Hp87510;"LIML ";Lower(I)
270   OUTPUT @Hp87510;"LIMSDON"
280 NEXT I
290 OUTPUT @Hp87510;"LIMEDONE" ! Done editing the limit line table
300 !
310 OUTPUT @Hp87510;"LIMITESTON"
320 OUTPUT @Hp87510;"*CLS"
330 EXECUTE "SING"                  ! Execute single sweep
340 !
350 ! Inform the result of limit line test by beep
360 OUTPUT @Hp87510;"ESB?"          ! Read limit test result from ESB
370 ENTER @Hp87510;Stat            ! then enter to variable "Stat"
380 IF BIT(Stat,4) THEN             ! If test is failed then beep 1 time
390   BEEP !FAIL (2 BEEPS)
400   WAIT .5
410   BEEP
420 ELSE                             ! If test is passed then beep 2 times
430   BEEP !PASS (1 BEEP)
440 END IF
450 !
460 END

```

Figure 10-5. Executing the Limit Line Test

Trace Data Transfer

There are two formats in which to transfer data to an Instrument BASIC program, ASCII and binary. The binary format transfers data faster, but the program is more complex than is the ASCII format transfer program, because it is necessary to specify the data format in detail. If you do not need high speed data transfer, use the ASCII data format because the program becomes simpler. If you want to transfer data faster, the binary data format transfer is appropriate. The following sample programs use both the ASCII and the binary formats.

Assume that the number of measurements points is 201.

Output Trace Data

The following sample programs transfer measurement data from the HP 8751A to data array "Dat". Figure 10-6 shows data transfer using ASCII format, Figure 10-7 shows data transfer using binary format.

```
10 ASSIGN @Hp87510 TO 800
20 DIM Dat(1:201,1:2)
30 OUTPUT @Hp87510;"HOLD"
40 OUTPUT @Hp87510;"FORM4"      ! Output in ASCII format
50 OUTPUT @Hp87510;"OUTPFORM?"
60 ENTER @Hp87510;Dat(*)
70 PRINT Dat(*)
80 END
```

Figure 10-6. Output ASCII Format Data

```
10 ASSIGN @Hp87510 TO 800
20 DIM Dat(1:201,1:2)
30 OUTPUT @Hp87510;"HOLD"
40 OUTPUT @Hp87510;"FORM3"      ! Output in IEEE 64bit format
50 ASSIGN @Dt TO 800;FORMAT OFF ! Set "@Dt" to binary data path
60 !
70 OUTPUT @Hp87510;"OUTPFORM?"
80 ENTER @Hp87510 USING "%,8A";Header$ ! Reading header
90 ENTER @Dt;Dat(*) ! Reading Trace data
100 ENTER @Hp87510 USING "%,1A";Terminate$ ! Reading Terminator
110 OUTPUT @Hp87510;"FORM4"      ! Set to ASCII format mode
120 END
```

Figure 10-7. Output Binary Format Data

Input Trace Data

Following sample programs transfer Instrument BASIC trace array data to the HP 8751A.

```

10 ASSIGN @Hp87510 TO 800
20 DIM Dat(1:201,1:2)
30 OUTPUT @Hp87510;"HOLD"           ! Halt sweep
40 OUTPUT @Hp87510;"FORM4"         ! Set to ASCII format mode
50 OUTPUT @Hp87510;"INPUFORM ";Dat(*) ! Send "Dat" data to trace
60 END

```

Figure 10-8. Input ASCII Format Data

In binary format, when the defined data length is different from the actual data length, an error occurs. You must set the length of both data to be equal. Data length is specified as an 8-byte string; data header. A data header consists "#6", and following 6-byte strings which shows size of data. For details of data headers, refer to Chapter 2 of *HP-IB Programming Manual*.

For instance, it assumes that number of points are 201, the entire data size becomes 3216 bytes because each points has 16-byte data. The data header expresses this size as the string, "#6003216".

```

10 ASSIGN @Hp87510 TO 800
20 DIM Dat(1:201,1:2)
30 OUTPUT @Hp87510;"HOLD"           !
40 OUTPUT @Hp87510;"FORM3"         ! Set format to IEEE 64bit
50 ASSIGN @Dt TO 800;FORMAT OFF     ! Set "@Dt" as data path
60 Nop=201                          ! Number of points are 201
70 Datasize=Nop*16                  ! Calculate data size
80 Headlength=LEN(VAL$(Datasize))  ! Enter Data length to Headlength
90 IF Headlength<6 THEN             !
100  Headstring$=VAL$(Nop*16)
110  REPEAT                          ! Enter "0" until 6 byte
120    Headstring$="0"&Headstring$
130    Headlength=LEN(Headstring$)
140  UNTIL Headlength=6
150 ELSE
160  Headstring$=VAL$(Nop*16)
170 END IF
180 OUTPUT @Hp87510 USING "#,9A";"INPUFORM " ! Start data transfer
190 OUTPUT @Hp87510 USING "#,K";"#6";Headstring$ ! Send header as 8 byte
200 OUTPUT @Dt;Dat(*),END          ! Send data and terminator
210 OUTPUT @Hp87510;"FORM4"       ! Back to ASCII format
220 END

```

Figure 10-9. Input Binary Format Data

ON KEY... LABEL Function

By using this sample program, several front key operations and BASIC processing steps can be combined and executed as a single softkey operation. For details of the "ON KEY" command, refer to *HP Instrument BASIC Language Reference*.

This sample program shows how to enter a user-defined function which is executable as a softkey command. Assume that the DUT is bandpass filter with a center frequency of 70 MHz.

```
10 ASSIGN @Hp87510 TO 800
20 ON KEY 1 LABEL "3dB" CALL Filter3db          !
30 ON KEY 2 LABEL "BndRejct" CALL Band_reject  !
40 ON KEY 8 LABEL "QUIT" GOSUB Quit           !
50 OUTPUT @Hp87510;"KEY 44"                  ! SYSTEM key
60 OUTPUT @Hp87510;"KEY 0"                   ! IBASIC key
70 OUTPUT @Hp87510;"KEY 7"                   ! ON KEY LABEL key
80 LOOP
90 END LOOP
100 Quit: !
110 END
120 !
130 SUB Filter3db
140  ASSIGN @Hp87510 TO 800
150  OUTPUT @Hp87510;"MARKOFF;MARK1 70MHZ"
160  OUTPUT @Hp87510;"DEL1;"
170  OUTPUT @Hp87510;"WIDTON;"
180  OUTPUT @Hp87510;"WIDV -3"
190 SUBEND
200 SUB Band_reject
210  ASSIGN @Hp87510 TO 800
220  OUTPUT @Hp87510;"MARKOFF;MARK1 70MHZ"
230  OUTPUT @Hp87510;"DEL1"
240  OUTPUT @Hp87510;"MARK2"
250  OUTPUT @Hp87510;"TRACKON"
260  OUTPUT @Hp87510;"SEAMIN"
270 SUBEND
```

Figure 10-10. On Key Label

I/O Operation from Instrument BASIC

This section describes the input/output operations using the 24-bit I/O port and the built-in disk drive. The following sample programs are covered in this section:

- Data transfer using the 24-bit I/O port
 - Reading data from the 24-bit I/O port
 - Writing data to the 24-bit I/O port
- Disk I/O for an built-in disk drive
 - Saving trace data
 - Loading trace data

Data Transfer Using the 24-bit I/O Port

Following two examples shows input and output operations of the 24-bit I/O port.

Reading Data from the 24-bit I/O Port

This sample program shows how to directly read a specific data bit from the 24-bit I/O port.

```
10 ASSIGN @Hp87510 TO 800
20 OUTPUT @Hp87510;"CIN"
30 Read_bit=2
40 A=BIT(READIO(15,2),Read_bit)    ! Reading data from C port
50 IF A THEN
60   PRINT "Specified bit is ON."  ! If A is true, bit2 is ON
70 ELSE
80   PRINT "Specified bit is OFF." ! If A is false, bit2 is OFF
90 END IF
100 END
```

Figure 10-11. Reading 24-bit I/O Port

This sample program shows a sample of writing data to the 24-bit I/O port. When you use the output port of the 24-bit I/O port, output data must be a decimal data. Although, binary-expressed data is useful and obviously to set each bit ON or OFF. If you want to set bit by bit of the output port using binary data, use the IVAL or DVAL command of Instrument BASIC. This command allows you to convert data from binary to decimal. The following example shows writing binary data to 24-bit I/O port by using the DVAL command.

```
10 DIM Bin_dat$(24)                ! Reserve space for 24 characters
20 Bin_dat$="111101011111001011011111" ! 24bit data in binary expression
30 ASSIGN @Hp87510 TO 800
40 OUTPUT @Hp87510;"COUT;DOUT"
50 Decimal_dat=DVAL(Bin_dat$,2)     ! Convert 24bit data to decimal
60 !
70 WRITEIO 15,7;Decimal_dat        ! Output data to 24-bit Output port
80 END
```

Figure 10-12. Writing Data to the 24-Bit I/O Port

Disk I/O for Built-in Disk Drive

The HP 8751A has a built-in disk drive and RAM disk memory. You can save or get data using these disks easily with Instrument BASIC.

Saving Trace Data

This sample program saves the HP 8751A's current raw measurement data to an arbitrarily named file.

```
10 ASSIGN @Hp87510 TO 800
20 DIM File_name$[10]
30 INPUT "ENTER FILE NAME (up to 10 Characters)",File_name$
40 !
50 OUTPUT @Hp87510;"SAVDDAT """;File_name$;""""
60 END
```

Figure 10-13. Saving Trace data

Loading Trace Data

This sample program loads trace data from the built-in disk drive into array "Dat".

```
10 ASSIGN @Hp87510 TO 800
20 INPUT "ENTER RETRIEBE FILE NAME (without EXT.)",File_name$
30 OUTPUT @Hp87510;"STODDISK" ! Select flexible disk drive
31 ! When you want to use RAM disk,
32 ! change "STODDISK" to "STODMEMO"
40 DIM Dat(1:201,1:2) ! Assume data size of "Dat" is 201 points
50 File_name$=File_name$&"_D" ! Add extension "_D" to filename *
51 ! When you want to use DOS format,
52 ! change extension "_D" to ".DAT"
60 ASSIGN @File TO File_name$ ! Open target file
70 ENTER @File USING "17X,#"
80 INTEGER Nop
90 ENTER @File;Nop
100 ENTER @File USING "4X,#"
110 ENTER @File;Dat(*) ! Load data from file
120 ASSIGN @File TO * ! Close file
130 PRINT Dat(*)
140 END
```

Figure 10-14. Loading Trace Data

Simultaneously using Instrument BASIC and an External Controller

This section describes sample programs that are useful when two controllers are used on the same bus. The following sample programs are covered:

- Passing control between controllers
- Transferring a program to Instrument BASIC
- Running an external controller program
- Referring to an external controller's data array contents

In this section, we assume that external controller and Instrument BASIC controller are connected with an HP-IB interface.

Passing Control

The HP-IB bus can only have one active controller at same time. If more than one controller is on the same bus, then the controllers must use a handshaking procedure to pass control from one controller to another.

This sample program shows how to pass control of an HP-IB bus from the external controller to Instrument BASIC. The external controller is active first. If Instrument BASIC attempts to print out before being passed control, then an HP-IB error will occur, an interrupt generated, and the program will jump to the label "Not_active". When it passes control to the HP 8751A, the program is released from the ERROR interrupt and will then execute a print out.

Assume that the following two programs are simultaneously running on an external controller and on HP 8751A Instrument BASIC program respectively. And, the printer is connected with the HP-IB interface.

```
10 Hp87510=717 *
20 INPUT "Press ENTER key",Answer$ ! Wait until ENTER key is pressed
30 PASS CONTROL Hp87510 ! Pass control to HP 87510A
40 END
```

Figure 10-15. Passing Control (for External Controller)

```
10 PRINTER IS 701 !
20 ON ERROR GOTO Not_active ! HP 87510A can not print until pass controlled,
30 Not_active:! ! program can not proceed to the next line
40 PRINT "HELLO, WORLD!" ! When pass controlled, exit and prints
50 OFF ERROR ! Cancel error intrrupt
60 END
```

Figure 10-16. Passing Control (for Instrument BASIC)

Transferring a Program to Instrument BASIC

This sample program transfers a program from an external controller's disk to Instrument BASIC memory through the HP-IB interface.

This sample program must be executed on the external controller.

```
10 ASSIGN @Hp87510 TO 717
20 OUTPUT @Hp87510;"*RST"
30 OUTPUT @Hp87510;"PROG:DEL:ALL" ! Scratch program on BASIC editor
40 INPUT "FILENAME?",File_name$
50 DIM Line${1024}
60 OUTPUT @Hp87510;"PROG:DEF #0" ! Send header
70 ASSIGN @File TO File_name$ ! Open file and assign data path
80 ON ERROR GOTO Done
90 LOOP
100 Line$=""
110 ENTER @File;Line$ ! Read and input program source code
120 OUTPUT @Hp87510;Line$ ! Send to external controller
130 END LOOP
140 Done: ! ! Ended reading from file
150 OFF ERROR ! Cancel error interrupt
160 OUTPUT @Hp87510;" " END ! Send terminator
170 ASSIGN @File TO * ! Close file
180 END
```

Figure 10-17. Program Download

Running an External Instrument BASIC Program

This sample program runs on an external controller and commands an HP 8751A to load a program from its own built-in disk, then run it.

Assume that the Instrument BASIC program file "PROGRAM1" is stored on the built-in disk of the external HP 8751A. This sample program is executed from the external controller.

```
10 ASSIGN @Hp87510 TO 717
20 OUTPUT @Hp87510;"PROG:DEF #0" ! Start program transfer
30 OUTPUT @Hp87510;"10 PRINT ""HELLO, WORLD!"" !
40 OUTPUT @Hp87510;"20 END" !
50 OUTPUT @Hp87510;" " END ! End of program transfer
60 !
70 OUTPUT @Hp87510;"PROG:STAT RUN" ! RUN sent program
80 END
```

Figure 10-18. Run External Instrument BASIC Program

You can run an external program using the following command in line 150 of the above program.

```
70 OUTPUT @Hp87510;"PROG:EXEC ""RUN"""
```

Accessing the Contents of a Data Array in an Instrument BASIC Program from an External Controller

This sample program shows how to read array data of an Instrument BASIC program from an external controller.

Assume that array "Dat" is defined as DIM Dat(1:201,1:2) in a program of the Instrument BASIC and contains trace data. This sample program must be executed from an external controller.

```
10 ASSIGN @Hp87510 TO 717
20 DIM Passed(1:201,1:2)
30 OUTPUT @Hp87510;"PROG:NUMB? ""Dat"";"
40 ENTER @Hp87510;Passed(*) ! Instrument BASIC's array "Dat" data is enter
50 ! ! to array "Passed"
60 END
```

Figure 10-19. Accessing External Controller's Program Array.

Application Programs

This section covers the following application programs:

- Sharing one printer with two controllers
- Loading BASIC programs using soft keys
- Using BIN sorting function with the 24-bit I/O port

These programs are executable as they stand, but you must make adjustments for your applications, such as frequency settings and so on.

Sharing One Printer Between Two Controllers

This program shows a sample of sharing one printer between two controllers. The HP 8751A and the external controller uses the printer in sequence, the HP 8751A uses the printer first. The following is assumed:

- Two controllers and one printer on the same HP-IB bus
- Figure 10-20 is executed on the external controller
- Figure 10-21 is in editor of the Instrument BASIC

```
10 Hp87510=717
20 !
30 OUTPUT Hp87510;"PROG:STAT RUN" ! Make Instrument BASIC run state
40 !
50 PRINTER IS 701
60 PRINT "THIS LINE IS PRINTED OUT FROM EXT. CONTROLLER."
70 PRINT "NOW I'LL PASS CONTROL TO ALLOW IBASIC TO USE PRINTER."
80 PRINT ""
90 PASS CONTROL Hp87510
100 ON ERROR GOTO Not_active
110 Not_active: ! Waiting until control is back
120 PRINT "THIS LINE IS PRINTED OUT FROM EXT. CONTROLLER AGAIN."
130 END
```

Figure 10-20. Sharing a Printer (Program for External Controller)

```

10 Printer=701
20 PRINTER IS Printer
30 ON ERROR GOTO Not_active
40 !
50 Not_active:!
60 PRINT "THIS LINE IS PRINTED FROM IBASIC"
70 ! Now I'm an active controller. I can freely use HP-IB.
80 PRINT "NOW I'LL DUMP 87510A'S SCREEN TO PRINTER"
90 ASSIGN @Hp87510 TO 800
100 OUTPUT @Hp87510;"DISABASS"
110 OUTPUT @Hp87510;"PRINALL"
120 PRINT "THIS LINE IS PRINTED OUT BELOW THE DUMP LIST."
130 PRINT "SO YOU'LL KNOW IF YOU USE HP-IB FROM IBASIC AND";
140 PRINT " INSTRUMENT AT THE SAME TIME,";
150 PRINT "PREEMPTIVELY EXECUTED PROCESS DOES WORK FIRST, THEN NEXT."
160 PRINT ""
170 !
180 !Now I've done my work, so I'll pass control back to the ext. controller
190 PASS CONTROL 721
200 END

```

Figure 10-21. Sharing a Printer (Program for Instrument BASIC)

Automatic Program Execution

This program displays up to eight program file names in the HP 8751A's softkey label area, from which one of the programs can be selected and executed by just pressing a softkey. This feature lets you execute a program without using the keyboard. You only need to select the softkey of the program you want to execute.

You can name this program file, "AUTOST", so it will be executed automatically when the HP 8751A is turned ON.

When you want to recall this program again after execution of an object file, you simply add the command GET "AUTOST" just before the END statement line of your object program code.

```
10 !ON KEY LABEL FUNCTION
20 !
30 ASSIGN @Hp87510 TO 800
40 DIM Dir$(1:200)[80],File$(1:200)[10]
50 !
60 CAT TO Dir$(*)
70 !
80 File_end=0
90 File_number=1
100 WHILE File_end=0 AND File_number<200
110   File$(File_number)=Dir$(File_number+7)[1,10]
120   IF File$(File_number)="" THEN
140     File_end=1
141     File_number=File_number-1
143   ELSE
144     File_number=File_number+1
150   END IF
170 END WHILE
180 !
190 Max_page=INT(File_number/6)+1
200 Npage=1
210 OUTPUT @Hp87510;"KEY 44"
220 OUTPUT @Hp87510;"KEY 0"
230 OUTPUT @Hp87510;"KEY 7"           ! Display ON KEY LABEL softkey
240 Head: !
250 Page=(Npage-1)*6
260   ON KEY 1 LABEL File$(Page+1) GOSUB Jump1
270   ON KEY 2 LABEL File$(Page+2) GOSUB Jump2
280   ON KEY 3 LABEL File$(Page+3) GOSUB Jump3
290   ON KEY 4 LABEL File$(Page+4) GOSUB Jump4
300   ON KEY 5 LABEL File$(Page+5) GOSUB Jump5
310   ON KEY 6 LABEL File$(Page+6) GOSUB Jump6
320   ON KEY 7 LABEL "NEXT PAGE" GOTO Jump7
330   ON KEY 8 LABEL "PREV.PAGE" GOTO Jump8
```

Figure 10-22. Automatic Program Execution (1/2)

```

340 !
350 LOOP
360 END LOOP
370 !
380 Jump1:GET File$(Page+1)
390 Jump2:GET File$(Page+2)
400 Jump3:GET File$(Page+3)
410 Jump4:GET File$(Page+4)
420 Jump5:GET File$(Page+5)
430 Jump6:GET File$(Page+6)
440 Jump7:Npage=Npage+1
450     IF Npage>Max_page THEN Npage=Max_page
460     GOTO Head
470 Jump8:Npage=Npage-1
480     IF Npage<=1 THEN Npage=1
490     GOTO Head
500 !
510 END

```

Figure 10-23. Automatic Program Execution (2/2)

BIN Sorting Using the 24-bit I/O Port

The HP 87510A has BIN sorting function which enables setting and testing, using a multiple limit line test feature. BIN sorting result output is only available through the I/O port. In this section shows an example using BIN sorting with handler and the 24-bit I/O port.

This program uses three ports of 24-bit I/O port. The first one is output A which is the output port for the BIN sorting result to an external handler. The other Rest two ports are OUTPUT1 and OUTPUT2. These ports are used to synchronize timing with a handler.

If the OUTPUT1 bit is set, it indicates that the instrument is ready to accept a trigger input from the handler. OUTPUT2 is used to indicate the instrument is processing data. In this example, although, the length of time of a bit set on OUTPUT2 is very short, because the processing time is very short.

```

10 !PROGRAM BIN SORT WITH HANDLER
20 ASSIGN @Hp87510 TO 800
30 !
40 ! Setting the Gain Phase Analyzer
50 OUTPUT @Hp87510;"CHAN1;AR;LOGM"
60 OUTPUT @Hp87510;"CENT 70MHZ;SPAN 0"
70 OUTPUT @Hp87510;"EXTTPOIN"
80 !
90 ! Editing the BIN sort table
100 OUTPUT @Hp87510;"BINCLEL"
110 OUTPUT @Hp87510;"EDITBINL"
120 OUTPUT @Hp87510;"BINSADD"
130 OUTPUT @Hp87510;"BINU 10DB;BINL -10DB"
140 OUTPUT @Hp87510;"BINP 1"
150 OUTPUT @Hp87510;"BINO 255"
160 OUTPUT @Hp87510;"BINSDON;BINSADD"
170 OUTPUT @Hp87510;"BINU 20DB;BINL -20DB"
180 OUTPUT @Hp87510;"BINP 2"
190 OUTPUT @Hp87510;"BINSDON;BINSADD"
200 OUTPUT @Hp87510;"BINU 30DB; BINL -30DB"
210 OUTPUT @Hp87510;"BINP 3"
220 OUTPUT @Hp87510;"BINSDON"
230 OUTPUT @Hp87510;"BINEDONE"
240 !
250 ! Setting the BIN sorting
260 OUTPUT @Hp87510;"BINOA"
270 OUTPUT @Hp87510;"BINSLINEON"
280 !
290 ! Setting the I/O port
300 OUTPUT @Hp87510;"NEGL"
310 OUTPUT @Hp87510;"OUT1ENVL" ! Output 1 indicates waiting for trigger input
320 OUTPUT @Hp87510;"OUT2ENVH" ! Output 2 indicates processing is in progress
330 !
340 ! Executing BIN sorting
350 ON ERROR GOTO 370
360 OUTPUT @Hp87510;"BINSON"
370 I=1
380 DISP I
390 LOOP
400   OUTPUT @Hp87510;"OUT1H"
410   REPEAT
420     OUTPUT @Hp87510;"INPT?"
430     ENTER @Hp87510;Inpt
440     UNTIL Inpt
450     OUTPUT @Hp87510;"EXTTPOIN; OUT2L"
460     I=I+1 ! Counts a number of DUT. If "I" value exceeds integer
470     DISP I ! limitation of Instrument BASIC, "I" value will reset to 0.
480   END LOOP
490 !
500 END

```

Figure 10-24. BIN sorting with 24-bit I/O Port

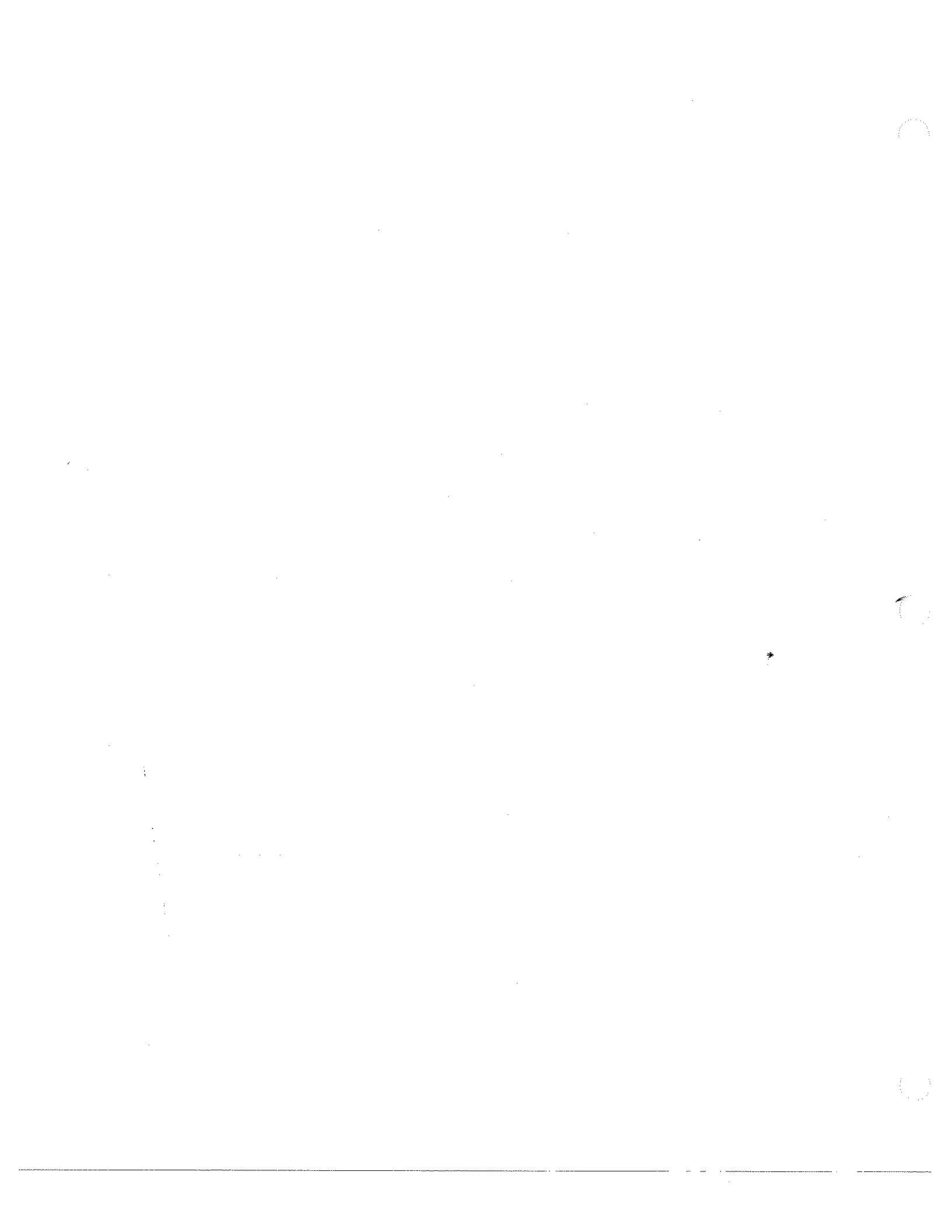

HP 87510A Specific HP Instrument BASIC Features

This chapter lists and summarizes the HP Instrument BASIC features specific to the HP 87510A. Details of each feature are described in the previous chapters and in the appendixes.

This chapter covers the following topics:

- I/O interfaces
- Display
- Keyboard
- Disk drive
- BASIC statements not implemented
- BASIC statements specific to HP 87510A
- HP-IB commands specific to Instrument BASIC

Available I/O Interface and Select Codes

Available interfaces and their select codes in HP 87510A Instrument BASIC are listed in the following table.

Select Codes	Devices
1	CRT
2	Keyboard
7	External HP-IB interface
8	Internal HP-IB interface

Note The HP 87510A does not have an RS-232C interface.



Display

The HP 87510A's Instrument BASIC has four display allocation types. The following table lists the number of lines and columns in the BASIC print area for each display allocation. It also shows the keyboard input line status for each allocation. When the keyboard input line is available, you can execute BASIC commands from the keyboard.

Display Allocation	BASIC Print Area		Keyboard Input Line
	Columns	Lines	
All Instrument	0	0	not available
Half INSTRument Half BASIC	58	12	available
ALL BASIC	58	24	available
BASIC Status	0	0	available

For more information on display allocation, refer to "Display Features" in Chapter 7.

The HP 87510A can be connected an external monitor. For information on the recommended monitor, refer to "SYSTEM ACCESSORIES AVAILABLE" in *General Information*.

Keyboard

For information on the keyboard, see Chapter 9.

Disk Drive

The HP 87510A's Instrument BASIC has the following disk drive limitations.

- External disk drives are not supported.
- HFS format is not supported.
- Disk types which can be initialized by the HP 87510A's Instrument BASIC INITIALIZE statement are 720 kByte (2DD, gray discs) and 1.44 MByte (2HD, black discs). 270 kByte (blue discs) discs can not be initialized.
- The only INITIALIZE format option is the default (256 byte/sector).

DOS formats supported. The DOS formats supported are:

- 720 kbyte, 80 tracks, double-sided, 9 sectors/track
- 1.44 Mbyte, 80 tracks, double-sided, 18 sectors/track

RAM Disk Memory

A part of the RAM (Random Access Memory) of the HP 87510A may be used as a virtual disk drive; RAM disk memory. RAM disk memory can operate same as internal disk drive. Accordingly, the usable RAM size is reduced to 63K bytes. The RAM, aided by a battery, can save data for 72 hours after the main power is shut off.

Note



Data in the RAM is saved for 72 hours after the HP 87510A is turned off. However, it is recommended that valuable programs and data be copied to floppy disk to avoid accidental destruction.

To switch system's storage units between the disk in the disk drive and RAM disk under control of the Instrument BASIC, use the following HP-IB commands:

STODDISK selects the built-in disk drive as a storage unit.
STODMEMO selects the RAM disk as a storage unit.

To copy a file between the disk and RAM disk, use an FILC command.

Note



The FILC command cannot be used to copy a file if the format (LIF or DOS) of the disk in the built-in disk drive is different from that of the RAM disk.

The RAM disk must be initialized before use. Select an LIF or DOS format before initialization. Use the front panel key or enter an HP-IB command to initialize the RAM disk. (For the procedure for initialization using the front panel, refer to Chapter 14 "Save and Recall Functions" of the HP 87510A Reference Manual.) When using an HP-IB command to initialize the RAM disk, execute the following procedure:

```
10 ASSIGN @Hp87510 TO 800
20 OUTPUT @Hp87510;"STORMEMO"
30 OUTPUT @Hp87510;"DISFLIF"
40 OUTPUT @Hp87510;"INID"
50 END
```

Figure 11-1.

BASIC Statements not Implemented

The following statements are listed in the *HP Instrument BASIC Language Reference* but not implemented in the HP 87510A's Instrument BASIC.

- OFF CYCLE
- ON CYCLE
- PEN

BASIC Statements Specific to HP 87510A

The following statements are NOT listed in the *HP Instrument BASIC Language Reference* but are available in the HP 87510A's Instrument BASIC.

- DATE
- DATE\$
- EXECUTE
- READIO
- SET TIME
- SET TIMEDATE
- TIME
- TIME\$
- WRITEIO

These keywords are described in Appendix A.

HP-IB Commands Specific to HP 87510A's Instrument BASIC

The HP 87510A's Instrument BASIC provides an HP-IB command set called "PROGram Subsystem", which is used to control HP 87510A's Instrument BASIC system from an external controller. These statements are only executable from external controllers. All PROGram subsystem commands are described in Appendix B.

BASIC Commands Specific to HP 87510A

DATE

Keyboard Executable Yes
 Programmable Yes
 In an IF ... THEN ... Yes

This function converts data formatted as (DD MMM YYYY) into the numeric value used to set the clock.

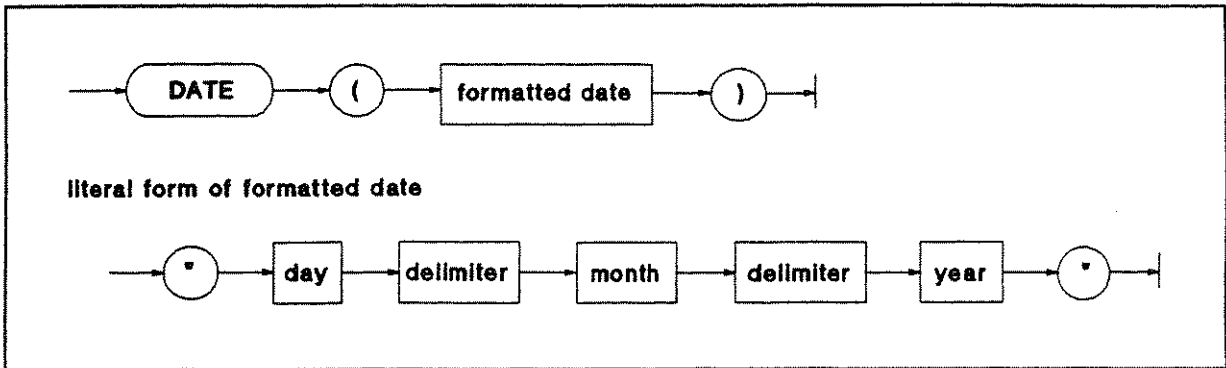

C271004

Item	Description	Range
formatted date	string expression	(see drawing and text)
day	integer constant	1 thru end-of-month
month	Literal (letter case ignored)	JAN, FEB, MAR, APR, MAR, APR, MAY, JUN, JUL, AUG, SEP, OCT, NOV, DEC
year	integer constant	1900 thru 2079

Example Statements

```
PRINT DATE("21 MAY 1991")
SET TIMEDATE DATE("1 Jan 1991")
Days=(DATE("1 JAN 1991")-DATE("11 NOV 1990")) DIV 86400
```

Semantics

Using a value from the DATE function as the argument for SET TIMEDATE will set the clock to midnight on the date specified. The results from the DATE and TIME functions must be combined to set the date and time of day.

If the DATE function is used as an argument for SET TIMEDATE to set the clock, the date must be in the range: 1 Mar 1900 thru 4 Aug 2079.

Specifying invalid date, such as the thirty-first of February, will cause an error.

Leading blanks or non-numeric characters are ignored. ASCII spaces are recommended as delimiters between the day, month and year. However, any non-alphanumeric character, except the negative sign (-), may be used as the delimiter.

DATE\$

Keyboard Executable	Yes
Programmable	Yes
In an IF ... THEN ...	Yes

This function formats the number of seconds into a date (DD MMM YYYY).

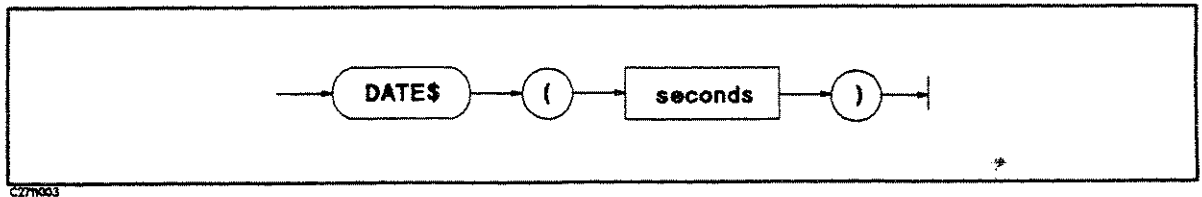

Item	Description	Range
seconds	numeric expression	-4.623 683 256E+12 thru 4.653 426 335 039 9E+13

Example Statements

```
PRINT DATE$(TIMEDATE)
DISP DATE$(2.111510608E+11)
```

Semantics

The date returned is in the form: DD MMM YYYY, where DD is the day of the month, MMM is the month mnemonic, and YYYY is the year.

The day is blank filled to two character positions. Single ASCII spaces delimit the day, month, and year.

The first letter of the month is capitalized and the rest are lowercase characters.

Years less than the year 0 are expressed as negative years.

EXECUTE

Keyboard Executable Yes
 Programmable Yes
 In an IF ... THEN ... Yes

This command executes specific HP-IB commands faster than OUTPUT statement.

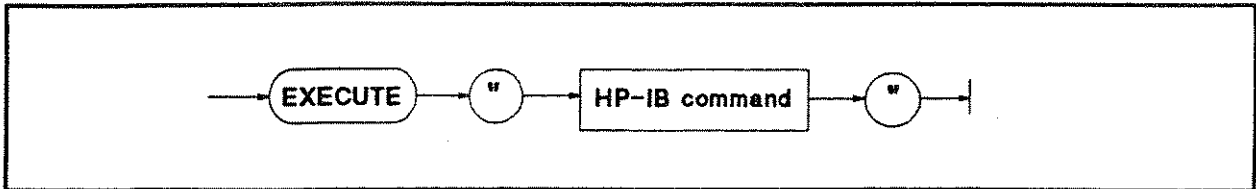

C470A009

Item	Description	Range
HP-IB command	string expression	refer to Table A-1

Table A-1. HP-IB Commands for EXECUTE

ANAOCH1	OUTPMAX?	LMAX?
ANAOCH1	OUTPMEAN?	LMIN?
ANAOCH2	OUTPMINMAX?	RPLVAL?
ANAODATA	OUTPFILT?	OUTPXFIL?
ANAOMEMO	OUTPRESO?	OUTPCFIL?
ANARANG	EQUCPARA?	OUTPRESR?
ANARFULL	EQUCPARS?	OUTPDATAT?
RPLPP?	POLE?	OUTPMEMOT?
RPLHEI?	PEAK?	THRR
RPLRHEI?	NEXP?	SING
RPLLHEI?	TARR?	OUTPDATTP?
RPLENV?	TARL?	OUTPMEMTP?
RPLMEA?	NUMLMAX?	INPUDATTP
OUTPMIN?	NUMLMIN?	INPUMEMTP

Note



The HP 87510A executes EXECUTE "SING" to carry out sweep once. Execution of the next statement is suppressed until sweep is completed. In this case, completion of the sweep need not be supervised using a status register.

Semantics

To transfer HP-IB command parameters, use a WRITEIO command. This command must be executed before the EXECUTE command. One WRITEIO command is required to transfer one parameter. For example, to transfer two ANARANGE command parameters to the EXECUTE command, write the program as follows:

```
WRITEIO 8,0; 100E6
WRITEIO 8,1; 200E6
EXECUTE "ANARANG"
```

The above program can also be written in the HP-IB command format as follows:

```
OUTPUT @HP87510;"ANAGNGE";100E6,200E6
```

Using an OUTPUT command reduces the number of source program lines. On the other hand, using an EXECUTE command accelerates the execution speed.

For the format of the WRITEIO command, refer to "WRITEIO."

To receive a query command's return value, use a READIO function. Since the READIO function returns only one specified return value, four return values (Za, Fa, Zr, and Fr) of the query command "OUTPRESO?" must be received by writing the program as follows:

```
EXECUTE "OUTPRESO?"
Za=READIO(8,0)
Fa=READIO(8,1)
Zr=READIO(8,2)
Fr=READIO(8,3)
```

The program can also be written in the HP-IB command format as follows:

```
OUTPUT @HP87510;"OUTPRESO?"
ENTER @HP87510;Za,Fa,Zr,Fr
```

Just like the transfer of HP-IB parameters, using an OUTPUT command reduces the number of source program lines and using an EXECUTE command accelerates the execution speed.

For the format of the READIO function, refer to "READIO."

GCLEAR

Keyboard Executable	Yes
Programmable	Yes
In an IF ... THEN ...	Yes

This statement PERFORMS the following functions:

- Clears the graphics screen
- MOVE 0,0 (see MOVE)

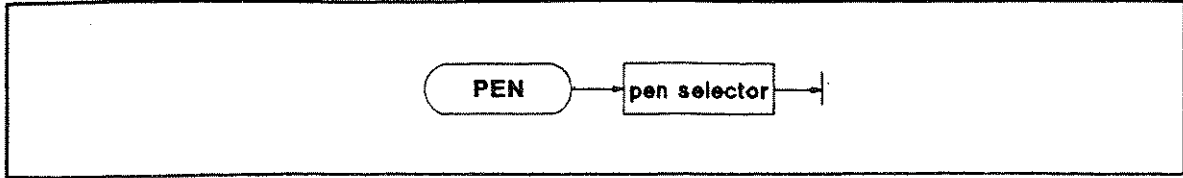

C271000

READIO

Keyboard Executable Yes
 Programmable Yes
 In an IF ... THEN ... Yes

This function reads the contents of the register used for an I/O port or EXECUTE command.

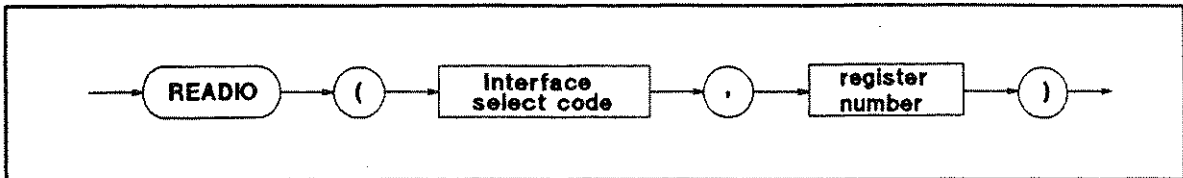

C271001

Item	Description	Range
select code	numeric expression	8: EXECUTE register 15: I/O port *
register number	numeric expression	0 to 800 (Select code 8) 2 to 4 (Select code 15); 0 (Select code 15:option 005 only)

Example Statements

```

Ioport=READIO(15,2)

100 EXECUTE "OUTPRES0?"
110 Za=READIO(8,0)
120 Fa=READIO(8,1)
130 Zr=READIO(8,2)
140 Fr=READIO(8,3)
  
```

Semantics

The HP 87510A uses the READIO command to read data from an I/O port or to receive a query command's return value after the EXECUTE command has been executed.

To receive a query command's return value, set the select code to 8. To read data from an I/O port, set the select code to 15.

The EXECUTE command stores the query command's return values in registers. The READIO command reads a return value from one of these registers. Return values are sequentially stored in registers 0 to 3. For example, when EXECUTE"OUTPURESO?" is executed, four return values Za, Fa, Zr, and Fr are stored in four registers, register 0 to register 3. Za is stored in register 0, Fa in register 1, Zr in register 2, and Fr in register 3. To read a return value stored by the READIO command, specify the appropriate register number. Refer to example statements.

To read data from an I/O port, specify the I/O port number with a register number. Relationships between I/O ports and register numbers are as follows:

Port Name	Register Number	Number of bit
Port C	2	4
Port D	3	4
Port E	4	8
Option 005 I/O port	0	4

SET TIME

Keyboard Executable Yes
 Programmable Yes
 In an IF ... THEN ... Yes

This statement resets the time-of-day given by the real-time clock.

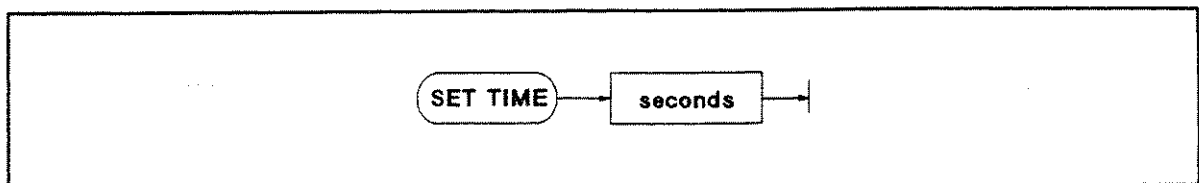

C271006

Item	Description	Range
seconds	numeric expression, rounded to the nearest hundredth	0 thru 86 399.99

Example Statements

```
SET TIME 0
SET TIME Hours*3600+Minutes*60
```

Semantics

SET TIME changes only the time within the current day, not the date. The new clock setting is equivalent to (TIMEDATE DIV 86 400)×86 400 plus the specified setting.

SET TIMEDATE

Keyboard Executable	Yes
Programmable	Yes
In an IF ... THEN ...	Yes

This statement resets the absolute seconds (time and day) given by the real-time clock.

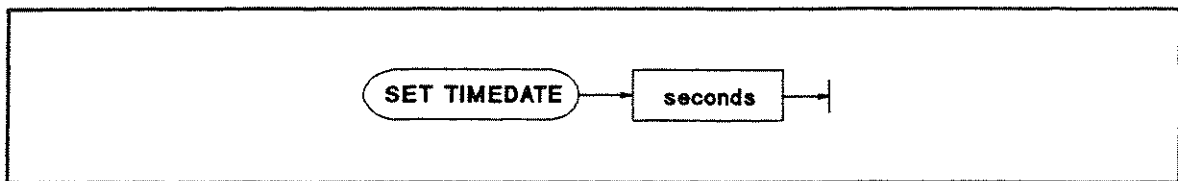

Item	Description	Range
seconds	numeric expression, rounded to the nearest hundredth	2.086 629 12E+12 thru 2.143 252 224E+11

Example Statements

```
SET TIMEDATE TIMEDATE+86400
SET TIMEDATE Strange_number
```

Semantics

The volatile clock is set to 2.086 629 12E+11 (midnight March 1, 1900) at power-on. If there is a battery-backed (non-volatile) clock, then the volatile clock is set to its value at power-up. If the computer is linked to an SRM system (and has no battery-backed clock), then the volatile clock is set to the SRM clock value when the SRM and DCOMM binaries are loaded. The clock values represent Julian time, expressed in seconds.

TIME

Keyboard Executable Yes
 Programmable Yes
 In an IF ... THEN ... Yes

This function converts data formatted as time of day (HH:MM:SS), into the number of seconds past midnight. (For information on using TIME as a secondary keyword, see the OFF TIME, ON TIME, and SET TIME statements. The OFF TIME and ON TIME are described in *HP Instrument BASIC Language Reference*.)

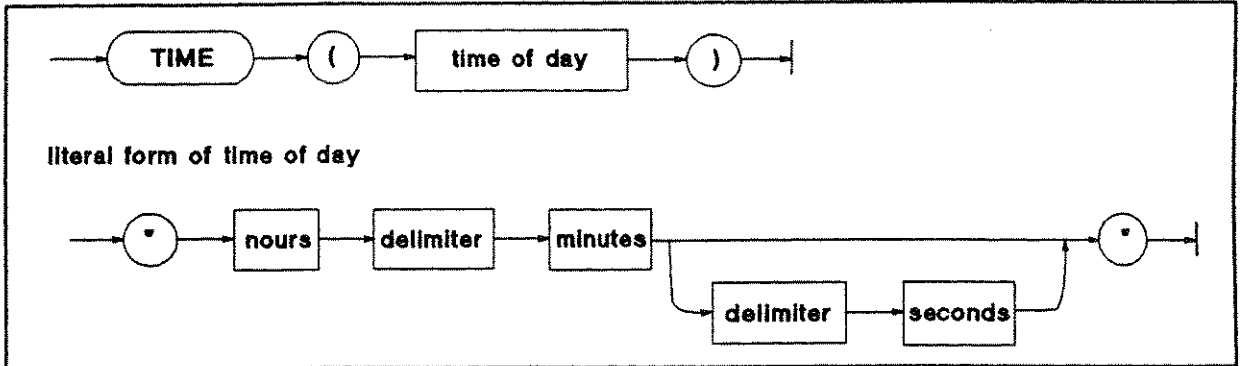

0271007

Item	Description	Range
time of day	string expression representing the time in 24 hour format	(set drawing)
hours	literal	0 thru 23 *
minutes	literal	0 thru 59
seconds	literal; default = 0	0 thru 59.99
delimiter	literal; single character	(see text)

Example Statements

```
Seconds=TIME(T$)
SET TIME TIME("8:37:20")
ON TIME TIME("12:10") GOSUB Lunch
```

Semantics

TIME returns a positive integer, in the range 0 thru 86,399, equivalent to the number of seconds past midnight.

While any number of non-numeric characters may be used as a delimiter, a single colon is recommended. Leading blanks and non-numeric characters are ignored.

TIME\$

Keyboard Executable Yes
Programmable Yes
In an IF ... THEN ... Yes

This function converts the number of seconds past midnight into a string representing the time of day (HH:MM:SS).

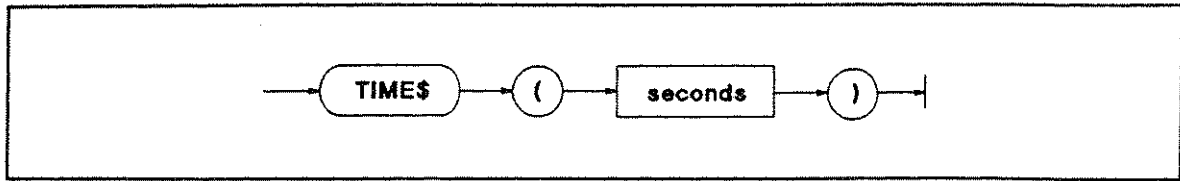

Item	Description	Range
seconds	numeric expression, truncated to the nearest second; seconds past midnight	0 thru 86 399

Example Statements

```
DISP "The time is: ";TIME$(TIMEDATE)
PRINT TIME$(45296)
```

Semantics

TIME\$ takes the time in seconds and returns the time of day in the form HH:MM:SS, where HH represents hours, MM represents minutes, and SS represents seconds. A module 86,400 is performed on the parameter before it is formatted as a time of day.

WRITEIO

Keyboard Executable Yes
Programmable Yes
In an IF ... THEN ... Yes

This statement writes register data in decimal notation to a specified EXECUTE command parameter register or to a specified I/O port.

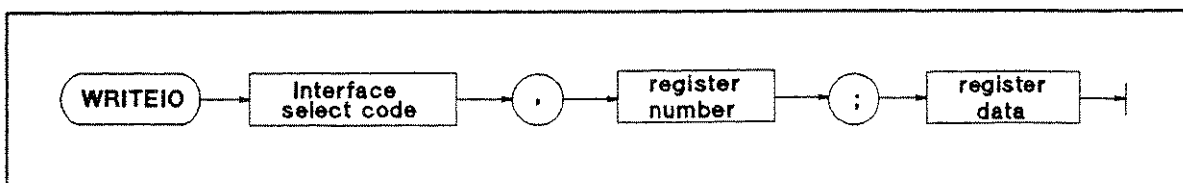

Item	Description	Range
select code	numeric expression	8: EXECUTE register 15: I/O port
register number	numeric expression	0 to 800 (Select code 8) 0 to 7 (Select code 15) 0 (select code 15:option 005 only)
register data	numeric expression	-2147483648 thru +2147483647

Example Statements

```
WRITEIO 15,0;12
WRITEIO 8,0;100E6
```

Semantics

The HP 87510A uses a WRITE command to write data to an I/O port or to transfer command parameters.

To transfer a parameter to the EXECUTE command, set the select code to 8. To write data to an I/O port, set the select code to 15.

The EXECUTE command uses the data stored in a register as a parameter. To store this parameter, the WRITEIO command must be executed before the EXECUTE command. The WRITEIO command stores one parameter in one register like the READIO command. For an HP-IB command that requires multiple parameters, as many WRITEIO commands as the number of parameters. For example, to execute an ANARANG command requiring two parameters using an EXECUTE command, specify the following:

```
WRITEIO 8,0; 100E6
WRITEIO 8,1; 200E6
EXECUTE "ANARANG"
```

The EXECUTE command sequentially reads parameters stored in registers. In the above example, parameters are stored in registers 0 and 1. Accordingly, the EXECUTE command reads 100E6 as the first parameter, then reads 200E6 as the second parameter.

When writing data to an I/O port, specify the I/O port number using the corresponding register number. Relationships between I/O port numbers and register numbers are as follows:

Port Name	Register Number	Number of bit
Port A	0	8
Port B	1	8
Port C	2	4
Port D	3	4
Port E	4	8
Port F	5	16
Port G	6	20
Port H	7	24
Option 005 I/O port	0	8

B

HP-IB Instrument BASIC Commands

This chapter provides descriptions of the PROGram subsystem, which is an HP-IB command set used to control the HP 87510A's Instrument BASIC. For example, an external controller can be used to control the retrieval and execution of Instrument BASIC programs from the HP 87510A's built-in disk drive. Commands under the PROGram subsystem are the common commands specified by Standard Commands for Programmable Instruments (SCPI).

For more information on SCPI, refer to *Beginner's Guide to SCPI* (P/N:H2325-90001). Order it at your nearest HP sales office.

Notation Conventions and Definitions

The following conventions and definitions are used in this chapter to describe HP-IB operation.

- < > Angular brackets enclose words or characters that are used to symbolize a program code parameter or an HP-IB command.
- [] Square brackets indicates that the enclosed items are optional.
- { } When several items are enclosed by braces, one and only one of these elements may be selected.

Command Structure

The HP 87510A commands are divided into three types: HP-IB common commands, HP-IB commands to control the HP 87510A and PROGram subsystem commands (SCPI commands). The HP-IB common commands are defined in IEEE std. 488.2-1987, and these commands are common for all devices. The HP-IB unique commands are used to control the HP 87510A. (Where possible, the unique commands are compatible with HP 8750 and HP 8510 series.) The HP-IB common and unique commands are described in *HP 87510AHP-IB Programming Manual*.

The commands under the PROGram subsystem are used to control Instrument BASIC with an external controller and they are described in this chapter. The PROGram subsystem has a tree structure which is nested three levels deep. So the lower level commands are legal only when the PROGram command have been selected. A colon (:) is used to separate the higher and lower level commands. See Figure B-1 for a sample.

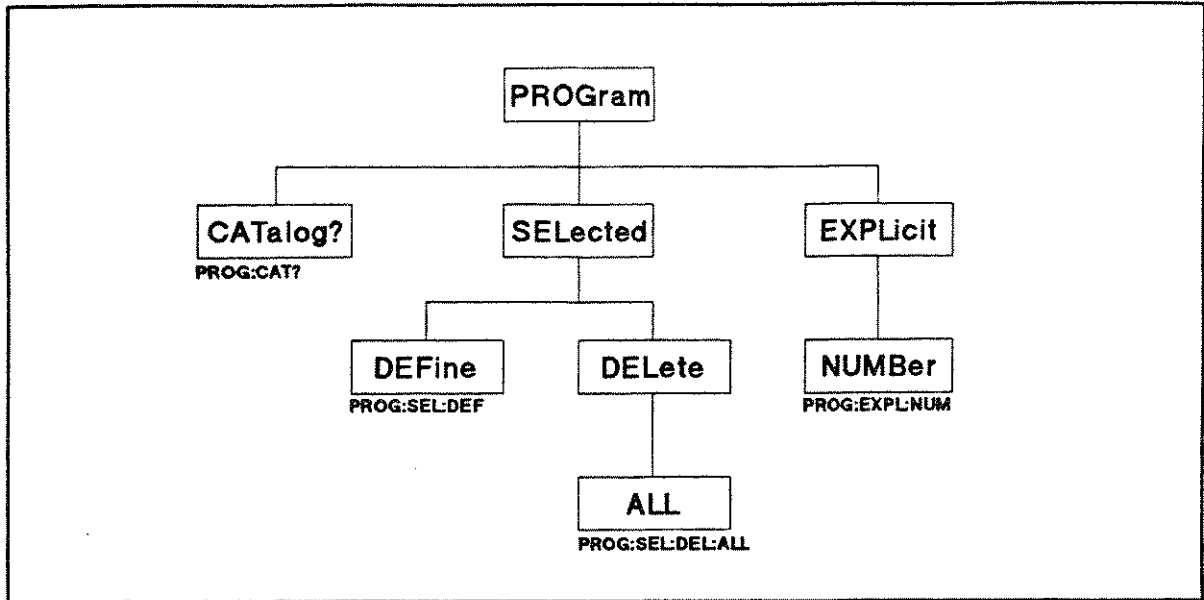

Figure B-1. Command Tree Example

Basic Rules

The basic rules of the command tree are as follows:

- Letter case (upper and lower) is ignored.

For example,
 PROG:CAT? = prog:cat? = Pr0g:CAt?

- Spaces (␣ used to indicate a space) must not be placed before and/or after the colon (:).

For example,
 (wrong) PR0G␣:␣CAT? → (right) PR0G:CAT?

- The command can be completely spelled out or be abbreviated. (The rules for command abbreviation are described later in this section)

For example,
 PROGRAM:CATALOG? = PROG:CAT?

- The command header should be followed by a question mark (?) to generate a query for that command.

For example,
 PROG:CAT?

The semicolon (;) can be used as a separator to execute multiple commands on a single line. The multiple command rules are as follows:

- Commands at the same level and in the PROGrama subsystem command group can be separated by a semicolon (;) on a multiple command line.

For example,
 PROG:STAT PAUSE:NUMB A;STAT CONT

- To restart commands from the highest level (PROGrama command), a semicolon (;) must be used as the separator, and then a leading colon (:), which shows that the restarted command is a command at the top of the command tree.

For example,
`PROG:NUMB A ; :PROG:EXPL:WAIT`

- The HP-IB common commands can restart only after a semicolon on a multiple command line.

For example,
`PROG:DEL:ALL;*RST`

- The HP-IB common commands keeps the previous command's level in a multiple command line.

For example,
`PROG:STAT STOP;*RST;STAT RUN`

- The HP-IB unique commands can restart only after a semicolon on a multiple command line.

For example,
`PROG:STAT STOP;CENT 100E6`

- After the HP-IB unique commands, the PROGram subsystem commands must restart from the highest level (:PROGram) since the unique commands do not keep the previous commands' level in a multiple command line.

For example,
`PROG:STAT STOP;CENT 100E6;:PROG:STAT RUN`

Command Abbreviations

Every command and character parameter has at least two forms, a short form and a long form. In some cases they will be the same. The short form is obtained using the following rules.

- If the long form has four characters or less, the long form and short form are the same.
- If the long form has more than 4 characters,
 - If the 4th character is a vowel, the short form is the first 3 characters of the long form.
 - If the 4th character is not a vowel, the short form is the first 4 characters.

For example:

`WAIT` abbreviates to `WAIT`
`DEFine` abbreviates to `DEF`
`STRing` abbreviates to `STR`
`PROGram` abbreviates to `PROG`

- If the long form mnemonic is defined as a phrase rather than as a single word, then the long form mnemonic is the first character of the first word(s) followed by the entire last word. The above rules, when the long form mnemonic is a single word, are then applied to the resulting long form mnemonic to obtain the short form.

For example:

Memory `ALLocate` abbreviates to `MALL`. (The long form is `MALLOCATE`.)

PROGRAM Subsystem

The purpose of the PROGRAM is to provide the administrative features needed to generate and control a BASIC program resident in an instrument.

Note



Because PROGRAM subsystem is designed to be compatible with other HP instruments, PROGRAM subsystem includes commands which are not necessary or used by the HP 87510A.

KEYWORDS	PARAMETER FORM	NOTES
PROGRAM		
:CATalog?		[query only]
[:SElected]		
:DEFine	<program>	
:DElete		[no query]
[:SElected]		
:ALL		
:EXECute	<program command>	[no query]
:MALLocate	{<nbytes> DEFault}	
:NAME	<programe>	
:NUMber	<varname>, <nvalues>	
:STATe	{RUN PAUSE STOP CONTinue}	
:STRing	<varname>, <svalues>	
:WAIT		
:EXPLicit		
:DEFine	<programe>, <program>	
:DElete	<programe>	
:EXECute	<programe>, <program command>	[no query]
:MALLocate	<programe>, {<nbytes> DEFault}	*
:NUMber	<programe>, <varname>, <nvalues>	
:STATe	<programe>, <{RUN PAUSE STOP CONTinue}>	
:STRing	<programe>, <varname>, <svalues>	
:WAIT		

:PROGRAM:CATalog?

The CATalog query commands returns program name "prog" if the HP 87510A Instrument BASIC gets a program. IF no programs are currently defined then the response is a null string (" ").

:PROGRAM[:SElected]:DEFine <program>

The DEFine command is used to create and down-load programs. The DEFine query is also used to up-load programs.

The <program> download must be arbitrary block program data containing lines of program code. The first line of <program> must be a header, which shows program size. There is two format of the header as follows:

- #0 Allows that OUTPUT statement can send program line until END is specified in OUTPUT statement.
- #NM... M Specifies program size defined.
N shows number of figures, which shows program size
M... M is program size in byte (N figures)

Each line of the program must be separated by <CR> or <CR><LF>. Any line in which a syntax error is detected will be turned into a comment and a Program syntax error (-285) will be generated. Where the size of <program> exceeds the amount of available memory in the instrument, program lines will be saved up to the point of memory overflow. When overflow occurs a Program syntax error (-285) error will be generated.

In the DEFine query, the selected program and its size will be returned. The selected program will be in either the PAUSed or STOPped state for the program to be up-loaded. If the program is in the RUN state a "Program currently running" error (-284) will be generated. The <program> will be up-loaded as definite length arbitrary block response data. The program size is returned at first line as the header, then program line will be returned.

PROGram[:SElected]:DELEte[:SElected]

Deletes the program on BASIC editor of the HP 87510A. If the program is in the RUN state a "Program currently running" error (-284) shall be generated.

:PROGram[:SElected]:DELEte:ALL

Deletes the program on BASIC editor of the HP 87510A. If the program is in the RUN state a "Program currently running" error (-284) shall be generated.

:PROGram[:SElected]:EXECute <program command>

Executes the program command. <program command> is string data representing any legal program command. If the string data is not legal, then a "Program syntax error" (-285) will be generated. The selected program will be in either the PAUSed or STOPped state before the EXECute command will be allowed. If the program is in the RUN state a "Program currently running" error (-284) will be generated.

:PROGram[:SElected]:MALLocate {<nbytes>|DEFault}

Performs no function in the HP 87510A's Instrument BASIC. HP 87510A's memory space is fixed at 512 kbyte.

:PROGram[:SElected]:NAME <programe>

Performs no function in the HP 87510A's Instrument BASIC.

:PROGram[:SElected]:NUMBer <varname>,<nvalues>

Sets or queries the contents of numeric program variables and arrays in the program on BASIC editor of the HP 87510A. The variable specified in <varname> should be the name of an existing variable in the selected program, otherwise an "Illegal variable name" error (-283) will be generated. <varname> can be either char data or string data. <nvalues> is a list of comma separated numeric values which are used to set <varname>. If the specified variable cannot hold all of the specified numeric values then a "Parameter not allowed" error (-108) will be generated.

:PROGrama[:SElected]:STATE {RUN|PAUSE|STOP|CONTinue}

The STATE command is used to either set the state or query the state of program on BASIC editor of the HP 87510A. The matrix below defines the effect of setting the STATE to the desired value from each of the possible current states. In certain cases a parameter error "Settings conflict" (-221) shall be generated.

Desired State	Current State		
	RUN	PAUSE	STOP
RUN	error (-221)	RUN	RUN
CONT	error (-221)	RUN	error (-221)
PAUSE	PAUSE	PAUSE	STOP
STOP	STOP	STOP	STOP

:PROGrama[:SElected]:STRing <varname>,<svalues>

The STRing command is used to set and query the contents of string program variables and arrays in program on BASIC editor of the HP 87510A. The variable specified in <varname> will be the name of an existing variable in the selected program, otherwise an "illegal variable name" error (-283) will be generated. <varname> can be either char data or string data. <svalues> is a list of comma separated strings which are used to set <varname>. If the specified variable cannot hold all of the specified string values then a "Parameter not allowed" error (-108) will be generated. If a string value is too long then it will be truncated when stored in the programs variable.

:PROGrama[:SElected]:WAIT

The WAIT command waits for the selected program to enter the non running state.

Note



Following commands under the EXPLICIT node perform functions the same as the ones under SElected node mentioned above. EXPLICIT commands are included in the HP 87510A due to keep compatibility with other SCPI instruments. So, you do not have to use EXPLICIT commands for the HP 87510A.

Note



Since the HP 87510A Instrument BASIC executes a single program at once, the program name for EXPLICIT commands is always PROG.

:PROGrama:EXPLICIT:DEFine <programe>,<program>

Refer to " :PROGrama[:SElected]:DEFine <program>".

:PROGRAM:EXPLICIT:DELETE *<program>*

Refer to "PROGRAM[:SELECTED]:DELETE[:SELECTED]".

:PROGRAM:EXPLICIT:EXECUTE *<programe>*,*<program command>*

Refer to ":PROGRAM[:SELECTED]:EXECUTE *<program command>*".

:PROGRAM:EXPLICIT:MALLOCATE *<programe>*, {*<nbytes>*|DEFAULT}

Refer to ":PROGRAM[:SELECTED]:MALLOCATE {*<nbytes>*|DEFAULT}".

:PROGRAM:EXPLICIT:NUMBER *<programe>*,*<varname>*,*<nvalues>*

Refer to ":PROGRAM[:SELECTED]:NUMBER *<varname>*,*<nvalues>*".

:PROGRAM:EXPLICIT:STATE *<programe>*, {RUN|PAUSE|STOP|CONTINUE}

Refer to ":PROGRAM[:SELECTED]:STATE {RUN|PAUSE|STOP|CONTINUE}".

:PROGRAM:EXPLICIT:STRING *<programe>*,*<varname>*,*<svalues>*

Refer to ":PROGRAM[:SELECTED]:STRING *<varname>*,*<svalues>*".

:PROGRAM:EXPLICIT:WAIT

Refer to ":PROGRAM[:SELECTED]:WAIT".



Index

2

24-bit I/O port, 7-1
24 bit I/O port, 7-5

A

All, B-5
All BASIC, 7-1
ALL BASIC, 3-2
All Instrument, 7-1
ALL INSTRUMENT, 3-2
Allocating screen area, 3-2
AUTOREC, 8-1
AUTOST, 8-1
Auto start, 8-1

B

Back space, 6-2
Backspace, 9-1
BASIC STATUS, 7-1
BASIC STATUS, 3-2

C

Caps, 9-1
CAT, 5-1
CAT?, B-4
Catalog?, B-4
Character Entry Keys, 9-1
Clear display, 9-3
Clearing line, 6-2
Clear line, 9-3
Command abbreviation, B-3
COMMAND ENTRY, 3-6
Command structure, B-1
Connecting keyboard, 2-1
Controlling instrument, 3-3
CREATE, 7-7
CREATE DIR, 7-7
CTRL, 9-1

D

DATE, A-1
DATE\$, A-2
DEF, B-4, B-6
Define, B-4, B-6
DEL, B-5, B-7

Delete, B-5, B-7

Delete char, 9-3
Delete line, 9-3
Deleting, 6-2
Deleting characters, 6-2
Display, 7-1, 11-2
DISPLAY ALLOCATION, 7-1
DISPLAY ALLOCATION, 3-2
DOS file system, 7-1
▼, 9-2
Duplicate file name, 5-1

E

Editing program, 6-1
Enter, 9-1, 9-3
Entering active function, 3-3
Entering titles, 3-3
ERROR 54, 5-1
EXEC, B-7
EXEC, B-5
Execute, B-5, B-7
EXECUTE, 8-2, A-3
Executing commands, 3-3
Experienced programmers, 1-2
External monitor, 11-2
External RUN/CONT connector, 7-1

F

Format option, 11-2

G

Getting into/out EDIT mode, 4-1, 6-1
Getting program, 5-1
Graphics, 7-1
Guide, 1-1

H

HALF INSTR HALF BASIC, 3-2
Half Instrument/Half BASIC, 7-1
Hard copy, 4-5
▼, 9-2
HP-HIL, 9-1
HP-IB address, 4-2
HP-IB command, B-1
HP-IB remote indicator, 7-3

I

IEEE 488.2, B-1
INITIALIZE, 11-2
Insert char, 9-3
Inserting, 6-2
Inserting characters, 6-2
Insert line, 9-3
"INTERNAL,4", 7-7
I/O interfaces, 11-1

J

Jumping lines, 6-2

K

Keyboard, 3-3, 9-1

L

L, 9-2
Listing file names, 5-1
Listing program, 4-1
Listing to printer, 4-5

M

MALL, B-5, B-7
Mallocate, B-5, B-7
MARD OFF, 8-2
MASS STORAGE IS, 7-7
Modifying text color, 7-1
Moving the cursor, 6-2
MSI, 7-7
Multiple command rules, B-2

N

NAME, B-5
Next, 9-2
Notation, 3-1
Notation conventions, B-1
NUMB, B-5, B-7
Number, B-5
Number , B-7

O

OFF CYCLE, 11-4
ON CYCLE, 11-4
On key label, 8-1

P

PEN, 11-4
Performing calculation, 3-3
Porting, 1-1
Prev, 9-2

Print, 9-1

PRINTER IS, 4-5
PRINTER IS CRT;WIDTH 80, 5-2
Printer's address, 4-5
Program speed, 8-1
Program subsystem, B-1

R

READIO, A-5
READIO, 7-7
Recalling line, 6-2
Reference, 1-2
Renumbering program, 6-1
Return, 9-1
R, 9-2
RMT, 7-3
RS-232C, 11-1
Run light indication, 7-3
Running program, 4-1

S

Saving program, 5-1
SCPI, B-1
Scrolling lines and pages, 6-2
SEL, B-5
Select, 9-1
Select code, 4-2
Select codes, 11-1
SET TIME, A-6
SET TIMEDATE, A-7
Shift, 9-1
STAT, B-6, B-7
State, B-6, B-7
STR, B-6, B-7
String, B-6, B-7

T

Tab, 9-1, 9-3
Text color, 7-1
TIME, A-8
TIME\$, A-9
Trigger signal, 7-7

U

U, 9-2

W

WAIT, B-6, B-7
WRITEIO, A-9
WRITEIO, 7-7
Writing program, 4-1

Manual Supplement

Calibration Sample Program

Introduction

This supplement describes a usage of sample program for measuring impedance or admittance characteristics of crystal resonator by using a π -network circuit and an HP 41941A/B impedance probe.

The sample program uses a 3-term calibration method which measures three standards, OPEN, SHORT, and LOAD. This compensates an error of a π -network circuit or an HP 41941A/B impedance probe and enables accurate measurement.

Usage of Sample Program

The file name of sample programs contained in sample program disk are as follows:

- PLCAL* calibrates π -network circuit using a 3-term calibration method.
ZPROBE_CAL calibrates HP 41941A/B impedance probe using a 3-term calibration method.

Preparation

The following items are required to run this program.

- Sample program disk (furnished: HP Part Number 87510-87002)
- Fixture and calibration standards (Select one of the selections listed below)
 - π -network circuit, shorting bar, and a 50 Ω standard resistor
 - HP 41941A/B impedance probe (calibration standards are furnished with the HP 41941A/B)

If you own keyboard, it will be convenient to enter the values. If you have not, sample program can be execute only using front panel keys of the HP 87510A.

Measurement Setup

You must set measurement settings before using the sample program.

1. Turn the HP 87510A ON.
2. Setup stimulus range and other settings to agree with your measurement settings.
3. Connect the π -network circuit or the impedance probe to the HP 87510A as shown in Figure 1-1.

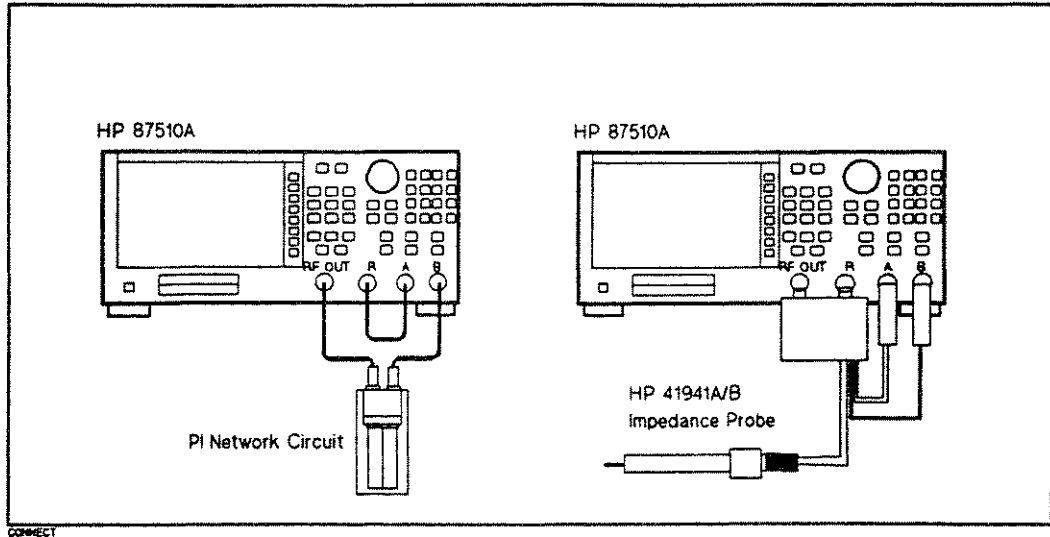

Figure 1-1. Measurement Configuration

Executing the SAMPLE PROGRAM.

4. Insert diskette into the disk drive.

5. Load program.

Press **SYSTEM** **IBASIC** **FILE UTILITY** **GET**.

When you use a π -network circuit, enter GET "PI_CAL" by using the rotary knob or keyboard, then press **DONE** or **Return**.

When you use an impedance probe, enter GET "ZPROBE_CAL" then press **DONE** or **Return**.

6. Run program.

Press **RUN** softkey from front-panel, or type RUN then press **Return** from keyboard.

7. Enter constants.

Pre-defined standard values are displayed on bottom half of the display.

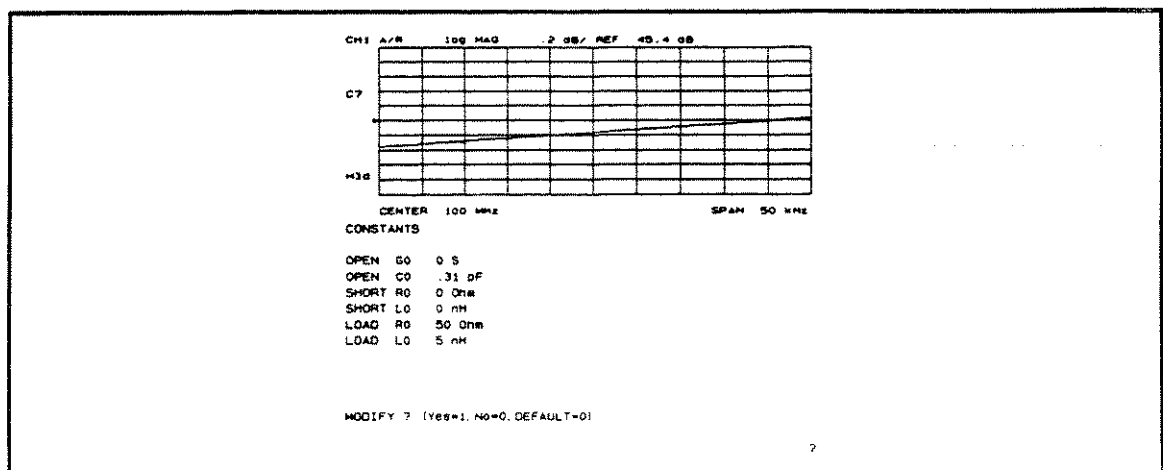

Figure 1-2. Standard Value Setting Menu

If you use the default value, just press the **x1** or **Return** key.

To change constants:

a. Type 1, then press **(x1)** or **(Return)** to modify standard values.

b. HP 87510A prompts for new standard value.

Enter new standard value by using numeric keys.

If you do not want to change the value, just press **(x1)** or **(Return)** for each standard.

After modification of standard values, HP 87510A asks you saving new data to file. If you want to save modified data, press **(x1)** or **(Return)** key. Saved data is used as default when you run program next time. If you want to use pre-defined data, purge files of "PL_DATA" in a case of "PL_CAL", or "Z_DAT" in a case of "ZPROBE_CAL" from disk.

8. Connect Standards and measure.

OPEN Connect nothing (π -network) or OS calibration standard (impedance probe), then press **OPEN**.

When completed, double parentheses enclose the **OPEN** softkey label.

SHORT Connect a short bar (π -network) or 0Ω calibration standard (impedance probe), then press **SHORT**.

When completed, double parentheses enclose the **SHORT** softkey label.

LOAD (50 ohm) Connect a 50 Ω standard (both), then press **LOAD**.

When completed, double parentheses enclose the **LOAD** softkey label.

To abort calibration, press **CAL BREAK**. The program will be terminated.

9. Complete measuring standards.

Press **DONE**, **3 TERM CAL** to complete calibration.

Message, "COMPUTING CAL COEFFICIENTS" will be displayed while the HP 87510A is calculating the calibration coefficients. After computation, calibration is completed with message and the HP 87510A gets ready for measurement, and then, the sample program is terminated.

Measurement

After running the sample program, the HP 87510A is calibrated and you can measure the crystal resonator. This section discusses how to measure the crystal resonator's impedance and admittance characteristics using the HP 87510A gain-phase analyzer.

Using the π -Network Circuit

Use the impedance conversion function of the HP 87510A when using the π -network circuit.

To see the characteristics of a crystal resonator in impedance format, press **(MEAS)** **(CONVERSION)** **Z:Trans**.

To see the characteristics of a crystal resonator in admittance format, press **(MEAS)** **(CONVERSION)** **Y:Trans**.

Using the Impedance Probe

When you use the HP 41941A/B impedance probe, conversion function is not necessary. Because the result is already displayed by impedance. If you want to read the value by marker directly, the HP 87510A must be set to the **(FORMAT)** **LIN MAG** format.

To see the characteristic of a crystal resonator in impedance format, press **(FORMAT)** **LOG MAG**

To see the characteristic of a crystal resonator in admittance format, press **FORMAT** **LOG MAG**, and **MEAS** **CONVERSION** **1/S**.

Actual Data for Standard

This section describes about the standard values used in the sample program.

π -Network Circuit

Figure 1-3 shows a standard model for standards of π -network circuit.

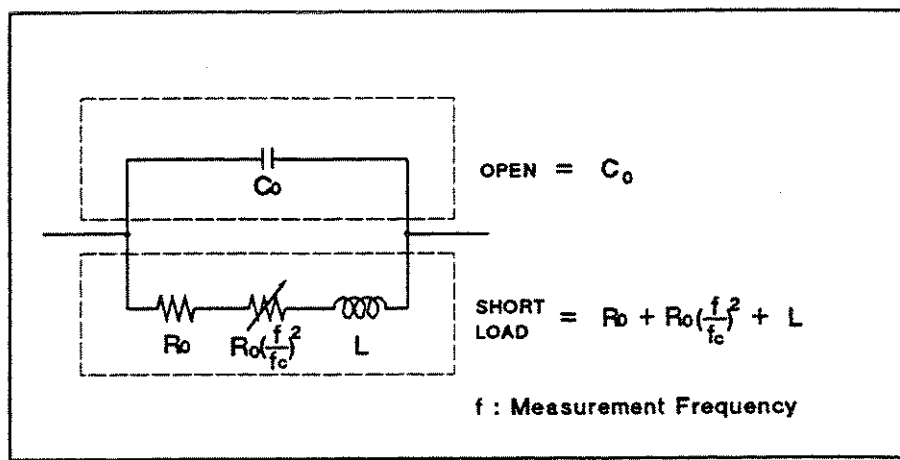

Figure 1-3. Equivalent Circuit of Standards

In the sample program, the default standard values are as follows:

Table 1-1. Default Values of the Standard for π -Network Circuit

Parameter	Standard Value		
	OPEN	SHORT	LOAD
C_0	0.1 pF	—	—
R_0	—	1 $\mu\Omega$	50 Ω
L	—	2 nH	8 nH
f_c	—	1.2 GHz	1.2 GHz

Impedance Probe

The reference values for the standard for HP 41941A/B impedance probe are given on page 3-2 of *HP 41941A/B Operation Note*. The sample program uses this data for the default values.

REGIONAL SALES AND SUPPORT OFFICES

For information relating to Sales or Support of Hewlett-Packard products first contact your local Hewlett-Packard office listed in the white pages of your telephone directory. If none is listed locally, contact one of the addresses listed below to obtain the address or phone number of the Hewlett-Packard Sales or Support office nearest you.

ASIA

Hewlett-Packard Asia Ltd.
47/F, 26 Harbour Road,
Wanchai, HONG KONG
G.P.O. Box 863, Hong Kong
Tel: (852)5-8330833
Telex: 76793 HPA HX
Cable HPSIAL TD

AUSTRALASIA

Hewlett-Packard Australia Ltd.
31-41 Joseph Street
BLACKBURN, Victoria 3130
Australia
Tel: (61)895-2895
Telex: 31-024
Cable: HEWPARD Melbourne

CANADA

Hewlett-Packard (Canada) Ltd.
6877 Goreway Drive
MISSISSAUGA, Ontario L4V 1M8
Tel: (416)678-9430
Telex: 069-8644

JAPAN

Yokogawa-Hewlett-Packard Ltd.
29-21 Takaido-Higashi, 3 Chome
Suginami-ku TOKYO 168
Tel: 03(331)6111
Telex: 232-2024 YHPTOK

MEDITERRANEAN AND MIDDLE EAST

Hewlett-Packard S.A.
Mediterranean and Middle East
Operations
Atrina Centre
32 Kifissias Avenue
Paradissos-Amarousion, ATHENS
Greece
Tel: (30)682 88 11
Telex: 21-6588 HPAT GR
Cable: HEWPACKSA Athens

May, 1990

BENELUX & SCANDINAVIA

Hewlett-Packard S.A.
Uilenstede 475
P.O. Box 999
NL-1183 AG AMSTELVEEN
The Netherlands
Tel: (31)20/43 77 71
Telex: 18 919 hpner nl

SOUTH & EAST EUROPE, AFRICA

Hewlett-Packard S.A.
7 rue du Bois-du-Lan
CH-1217 MEYRIN 2, Geneva
Switzerland
Tel: (41)22/83 12 12
Telex: 27835 hmea
Cable: HEWPACKSA Geneva

FRANCE

Hewlett-Packard France
Parc d'activites du Bois Briard
2, avenue du Lac
91040 EVRY Cedex
Tel: 1 6/077 83 83
Telex: 6923 15F

GERMAN FEDERAL REPUBLIC

Hewlett-Packard GmbH
Hewlett-Packard-Strasse
Postfach 1641
D-6380 BAD HOMBURG
West Germany
Tel: 06172/400-0
Telex: 410 844 hpbhg

ITALY

Hewlett-Packard Italiana S.p.A.
Via G. Di Vittorio 9
1-20063 CERNUSCO SUL
NAVIGLIO
(Milano)
Tel: 02/92 36-91
Telex: 334632

UNITED KINGDOM

Hewlett-Packard Ltd.
King Street Lane
Winnersh, WOKINGHAM
Berkshire RG11 5AR
Tel: 734/78/ 47 74
Telex: 847178

EASTERN USA

Hewlett-Packard Co.
4 Choke Cherry Road
ROCKVILLE, MD 20850
TEL: (301)670-4300

MIDWESTERN USA

Hewlett-Packard Co.
5201 Tollview Drive
ROLLING MEADOWS, IL 6008
Tel: (312)255-9800

SOUTHERN USA

Hewlett-Packard Co.
2000 South Park Place
P.O. Box 105005
ATLANTA, GA 30348
Tel: (404)955-1500

WESTERN USA

Hewlett-Packard Co.
5161 Lankershim Blvd.
P.O. Box 3919
NO. HOLLYWOOD, CA 91609
Tel: (818)506-3700

OTHER INTERNATIONAL AREAS

Hewlett-Packard Co.
Intercontinental Headquarters
3495 Deer Creek Road
PALO ALTO, CA 94304
Tel: (415)857-1501
Telex: 034-8300
Cable: HEWPACK

